

2017

Flexural behaviour of BFRP rebar reinforced concrete beams

Rudzinskis, E.

Rudzinskis, E. (2017) '

<http://hdl.handle.net/10026.1/14163>

The Plymouth Student Scientist

University of Plymouth

All content in PEARL is protected by copyright law. Author manuscripts are made available in accordance with publisher policies. Please cite only the published version using the details provided on the item record or document. In the absence of an open licence (e.g. Creative Commons), permissions for further reuse of content should be sought from the publisher or author.

1. Appendices

10.01 Basalt Rebar Tensile Test



Photo 1 – BFRP Rebar Sample Ends Sheared Off During Tensile Strength Test.



Photo 2 – BFRP Rebar Pulled Out from Aluminium Encasement.



Photo 3 - Extensometer BFRP Rebar Inside The Testing Machine



Photo 4 – BFRP Spiral Sanded Off at Each End. Test Failed by one end crushed.

Damaged “teeth” on the left-hand side.



Photo 5 – Damaged Upper Tensile Strength Testing Machine Clamp.

10.02 Concrete Cubes Class C40/50 Mix

Concrete mix design was based on BS 8500-1-2005+A1 and “Design of Normal Concrete Mixes” design manual (refer to list of references).

Table 1 Concrete mix design form

		Job title					
		Dissertation					
Stage	Item	Reference or calculation	Values				
1	1.1	Characteristic strength	Specified { Cube: 50 N/mm ² at 28 days				
			Proportion defective %				
	1.2	Standard deviation	Fig 3 0 N/mm ² or no data - N/mm ²				
	1.3	Margin	C1 (k = 1.64) × = N/mm ²				
			or Specified N/mm ²				
	1.4	Target mean strength	C2 0 + 50 = 50 N/mm ²				
	1.5	Cement strength class	Specified 42.5, 52.5				
	1.6	Aggregate type: coarse Aggregate type: fine	Crushed /uncrushed Crushed /uncrushed				
1.7	Free-water/cement ratio	Table 2, Fig 4 } Use the lower value					
1.8	Maximum free-water/cement ratio	Specified } 0.45					
2	2.1	Slump or Vebe time	Specified Slump S2, 80 mm or Vebe time s				
	2.2	Maximum aggregate size	Specified 20 mm				
	2.3	Free-water content	Table 3 225 kg/m ³				
3	3.1	Cement content	C3 225 + 0.45 = 500 kg/m ³				
	3.2	Maximum cement content	Specified kg/m ³				
	3.3	Minimum cement content	Specified kg/m ³				
	3.4	Modified free-water/cement ratio	use 3.1 if ≤ 3.2 use 3.3 if > 3.1 } 500 kg/m ³				
4	4.1	Relative density of aggregate (SSD) 2.7 known , assumed				
	4.2	Concrete density	Fig 5 2375 kg/m ³				
	4.3	Total aggregate content	C4 2375 - 500 - 225 = 1650 kg/m ³				
5	5.1	Grading of fine aggregate	Percentage passing 600 µm sieve 53. %				
	5.2	Proportion of fine aggregate	Fig 6 38. %				
	5.3	Fine aggregate content	C5 { 0.38 × 1650 = 627 kg/m ³				
	5.4	Coarse aggregate content	 1650 - 627 = 1023 kg/m ³			
Quantities		Cement (kg)	Water (kg or litres)	Fine aggregate (kg)	Coarse aggregate (kg)		
					10 mm	20 mm	40 mm
per m ³ (to nearest 5 kg)		500	225	627	341	682	
per trial mix of m ³							

Items in italics are optional limiting values that may be specified (see Section 7).
 Concrete strength is expressed in the units N/mm². 1 N/mm² = 1 MN/m² = 1 MPa. (N = newton; Pa = pascal).
 The internationally known term 'relative density' used here is synonymous with 'specific gravity' and is the ratio of the mass of a given volume of substance to the mass of an equal volume of water.
 SSD = based on the saturated surface-dry condition.

10.03 Class C28/35 Concrete Design Mix

Concrete mix design was based on BS 8500-1-2005+A1 and “Design of Normal Concrete Mixes” design manual (refer to list of references).

Table 1 Concrete mix design form

		Job title ...Dissertation.....					
Stage	Item	Reference or calculation	Values				
1	1.1	Characteristic strength	Specified { Cube: 35 N/mm ² at 28 days				
			Proportion defective %				
	1.2	Standard deviation	Fig 3 { 0 N/mm ² or no data				
	1.3	Margin	C1 or Specified { (k =) × = N/mm ²				
	1.4	Target mean strength	C2 { 0 + 35 = 35 N/mm ²				
	1.5	Cement strength class	Specified { 42.5, 52.5				
	1.6	Aggregate type: coarse Aggregate type: fine	Crushed/uncrushed Crushed/uncrushed				
	1.7	Free-water/cement ratio	Table 2, Fig 4 { 0.68				
1.8	Maximum free-water/cement ratio	Specified { } Use the lower value					
2	2.1	Slump or Vebe time	Specified { Slump S2, 80 mm or Vebe time s				
	2.2	Maximum aggregate size	Specified { 20 mm				
	2.3	Free-water content	Table 3 { 225 kg/m ³				
3	3.1	Cement content	C3 { 225 + 0.68 = 330 kg/m ³				
	3.2	Maximum cement content	Specified { kg/m ³				
	3.3	Minimum cement content	Specified { kg/m ³				
	3.4	Modified free-water/cement ratio	use 3.1 if ≤ 3.2 use 3.3 if > 3.1 { 330 kg/m ³				
4	4.1	Relative density of aggregate (SSD) 2.7 known/assumed				
	4.2	Concrete density	Fig 5 { 2375 kg/m ³				
	4.3	Total aggregate content	C4 { 2375 - 330 - 225 = 1820 kg/m ³				
5	5.1	Grading of fine aggregate	Percentage passing 600 µm sieve 53 %				
	5.2	Proportion of fine aggregate	Fig 6 { 42 %				
	5.3	Fine aggregate content	C5 { 0.42 × 1820 = 764 kg/m ³				
	5.4	Coarse aggregate content		1800 - 764 = 1056 kg/m ³			
Quantities		Cement (kg)	Water (kg or litres)	Fine aggregate (kg)	Coarse aggregate (kg)		
					10 mm	20 mm	40 mm
per m ³ (to nearest 5 kg)		330	225	765	350	705	
per trial mix of 0.065 m ³		21.45	14.625	49.725	22.75	45.825	

Items in italics are optional limiting values that may be specified (see Section 7).
Concrete strength is expressed in the units N/mm². 1 N/mm² = 1 MN/m² = 1 MPa. (N = newton; Pa = pascal).
The internationally known term 'relative density' used here is synonymous with 'specific gravity' and is the ratio of the mass of a given volume of substance to the mass of an equal volume of water.
SSD = based on the saturated surface-dry condition.

Per 4 beams = 0.18 m³ 63.0 40.50 14.5 60.3 119.7

B
4x (0.2x0.15x1.5) = 4x(Depth x Breadth x Length) D















Photo 6–Aggregate Quantities for Concrete Mix.



Photo 7 – Plasticiser “MasterPolyheed”

Control of Substances Hazardous to Health (COSHH) Assessment

Faculty/Department: Science and Engineering		School/Section: School of Engineering / Civil and Coastal Engineering	
Assessment No.		Assessor: Tony Tapp	
Description of procedure or experiment (Include how long and how often this is carried out and the quantity of substance used).	BASF MasterPolyheed 410, a mid range plasticizer admixture based on polycarboxylate ether, used in concrete mixes to increase workability or to lower the water/cement ratio while maintaining workability. Added to a mix at a rate of 0.5 to 2% by weight of cement by incorporating into the final 40% of the mixing water. Product is supplied in 1 litre plastic screw-top container.		
Identify the persons at risk:	Staff <input checked="" type="checkbox"/>	Contractors <input type="checkbox"/>	Public/students <input checked="" type="checkbox"/>
Name the substance involved in the process, the supplier (if known) and the information source.	BASF MasterPolyheed 410, supplied as a light brown coloured alkali liquid which is soluble in water. Supplier: BASF plc, PO Box 4, Earl Road, Cheadle Hulme, Cheadle, Cheshire, SK8 6QG; 0161 485 6222; product-safety-north@basf.com ; Emergency: 0049 180 2273 112		
Classification (state the category of danger, tick all that apply)			
 <input type="checkbox"/> Very Toxic	 <input checked="" type="checkbox"/> Irritant	 <input type="checkbox"/> Carcinogenic	 <input type="checkbox"/> Gas under pressure
 <input type="checkbox"/> Toxic	 <input type="checkbox"/> Sensitiser	 <input type="checkbox"/> Highly flammable	
 <input type="checkbox"/> Corrosive	 <input type="checkbox"/> Explosive	 <input type="checkbox"/> Flammable	
 <input type="checkbox"/> Harmful	 <input type="checkbox"/> Oxidising	 <input type="checkbox"/> Environment	
Hazard Type (tick all that apply)			
<input type="checkbox"/> Gas	<input type="checkbox"/> Vapour	<input checked="" type="checkbox"/> Mist	<input type="checkbox"/> Fume
<input type="checkbox"/> Dust	<input checked="" type="checkbox"/> Liquid	<input type="checkbox"/> Solid	<input type="checkbox"/> Other (Details)
Route of Exposure (tick all that apply)			
<input checked="" type="checkbox"/> Inhalation	<input checked="" type="checkbox"/> Skin	<input checked="" type="checkbox"/> Eyes	<input checked="" type="checkbox"/> Ingestion
<input type="checkbox"/> Other	(Details)		
Workplace Exposure Limits (WELs) please indicate n/a where not applicable			
Long-term exposure level (8hrTWA): No limits given.		Short-term exposure level (15 mins): No limits given.	
State the Risks to Health from Identified Hazards (include Risk Phrases)			
R36/38 - Irritating to eyes and skin; S37/39 - Wear suitable gloves and eye/face protection.			

Control Measures: (for example extraction, ventilation, training, supervision). Include special measures for vulnerable groups, such as disabled people and pregnant workers. Take account of those substances that are produced from activities undertaken by another employer's employees. (include Safety Phrases)









Wear PPE. Avoid aerosol generation.

Can a less hazardous substance be used? Yes No

If YES why is it not being used?:

Is health surveillance or monitoring required? Yes No

Personal Protective Equipment (state type and standard)

 <input type="checkbox"/>	Dust mask	 <input checked="" type="checkbox"/>	Visor	To avoid splashes.
 <input type="checkbox"/>	Respirator	 <input checked="" type="checkbox"/>	Goggles	EN166 class 2FT or better.
 <input checked="" type="checkbox"/>	Gloves	Impermeable / chemical resistant; EN374	 <input type="checkbox"/>	Overalls
 <input type="checkbox"/>	Footwear		 <input type="checkbox"/>	Other

First Aid Measures

In all cases seek medical attention if symptoms persist. **Inhalation:** Remove casualty to fresh air. **Skin contact:** Wipe off immediately; wash with soap and plenty of warm water. Seek medical attention if irritation develops. **Eye contact:** Flush with water for at least 15 minutes. Seek immediate medical attention. **Ingestion:** Rinse mouth, then drink plenty of water; seek medical attention.

Spillage/Uncontrolled Release Procedures

Do not breathe vapours. Wear PPE. Avoid discharge into watercourses or drains. Contain spill and absorb spill with an inert absorbent or cloth; place collected product into suitable container for disposal.

Storage

Store at room temperature in tightly closed original container.

Disposal of Substances & Contaminated Items

<input type="checkbox"/>	<input checked="" type="checkbox"/>	<input type="checkbox"/>	<input type="checkbox"/>	<input type="checkbox"/> (Details)
Hazardous Waste	Skip	Run to Drain	Return to Supplier	Other

Name of Assessor: Tony Tapp	Signed: 	Date: 22/12/2016
Name of Safety Manager/ HOS/ HOD:	Signed:	Date:
Review Date:	Signed:	Date:
Review Date:	Signed:	Date:

BFRP Rebar COSHH Assessment Form

Material Safety Data Sheet	Vulkan- Europe B.V.
Basalt Continuous Filament Fibres	Continuous Basalt Fibre Distributor
Date of print : 21-11-2016	

<p>1) Identity and Distributor information.</p> <p>Identity of the Distributor.</p>	<p>Basalt fibre components : yarns , rovings , chopped strands , fabrics , non-woven mats , nets . With epoxy : rebars of different diameters , wall ties and composite mesh.</p>  <p>Raesbergenstraat 47 2804TJ Gouda The Netherlands. Tel: +31 182 535520 Mob: +31 6 54 907 214 E-mail : j.dewit@vulkan-europe.com Web site : www.vulkan-europe.com</p>
<p>4. Emergency and First Aid Procedures.</p> <p>Inhalation :</p> <p>Skin Contact:</p> <p>Eye contact :</p> <p>Ingestion :</p>	<p>No specific treatment is necessary as this material is not likely to be inhaled, unless the material is in dust form : see infra 8.</p> <p>Wash with soap and running water .</p> <p>Immediately flush with plenty of water . Get medical attention if problem develops.</p> <p>Ingestion of this material is unlikely. If it does occur , get medical attention .</p>

	application . (if the respirable fraction of 5 mg/m ³ is reached)
12. Ecology.	N/A. Basalt has its origin in nature.
16. Other Information .	All data in the MSDS are based on the current state of knowledge , however they do not certify product properties and they do not justify legal liability. Vulkan- Europe bv. as the distributor cannot control the use of the end-product, the consumer has to determine under which circumstances the product can be used safely, This Material Safety Data Sheet is exclusively intended for professional use.



Raesbergenstraat 47

2804TJ Gouda

The Netherlands.

Tel: +31 182 535520

Mob: +31 6 54 907 214

E-mail : j.dewit@vulkan-europe.com

Web site : www.vulkan-europe.com

10.06 Reinforcing Cage Photos



Photo 8 – BFRP and Steel Reinforcement Setup in Beams B2 and B4.



Photo 9 - BFRP and Steel Reinforcement Setup in Beams B1, B2 and B4

10.07 **Concrete Cube Curing**



Photo 10 – Concrete (C28/35) Concrete Cube Curing Inside the Water Chamber.

10.08 **Location of external displacement gauge.**



Photo 11 – External Vertical Displacement Gauge Location 1.

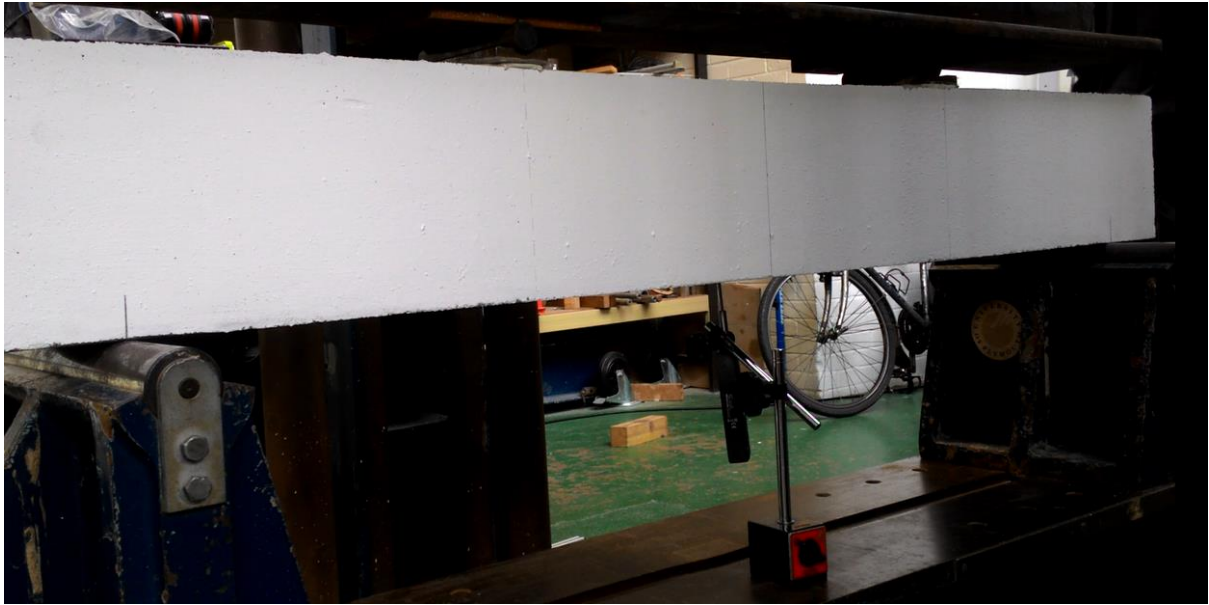

Photo 12 - External Vertical Displacement Gauge Location 2.

10.09 **Crack Propagation**

10.09.1 *Beam B1 (Control Beam)*



10.09.2 Beam B2

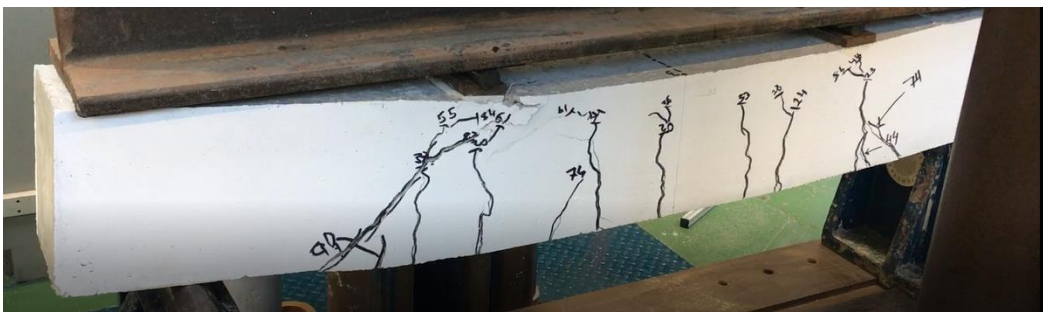
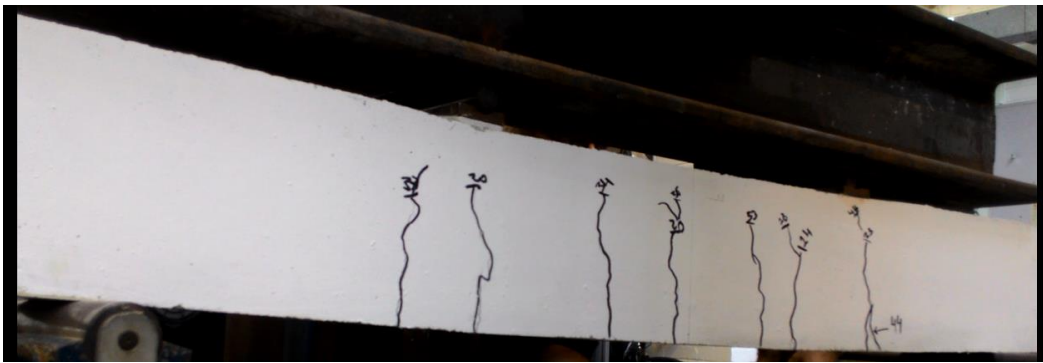
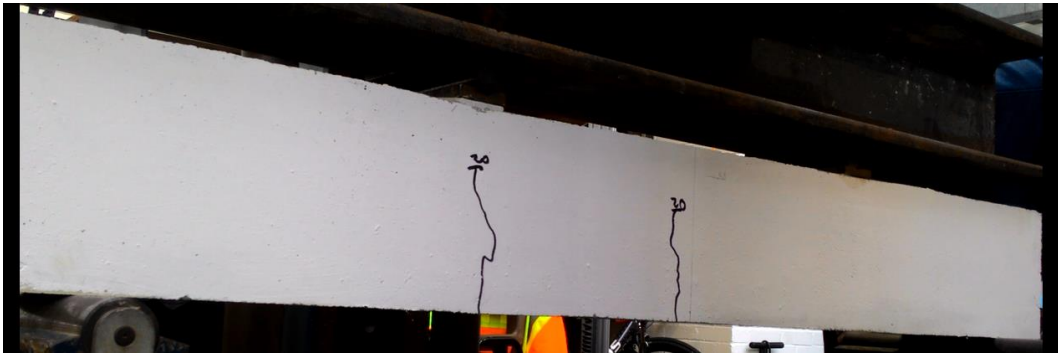

10.09.3 *Beam B3*

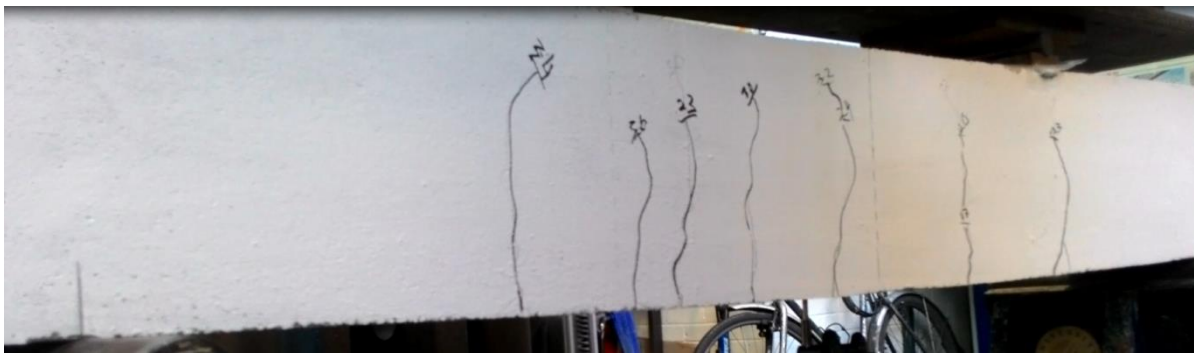

10.09.4 Beam B4

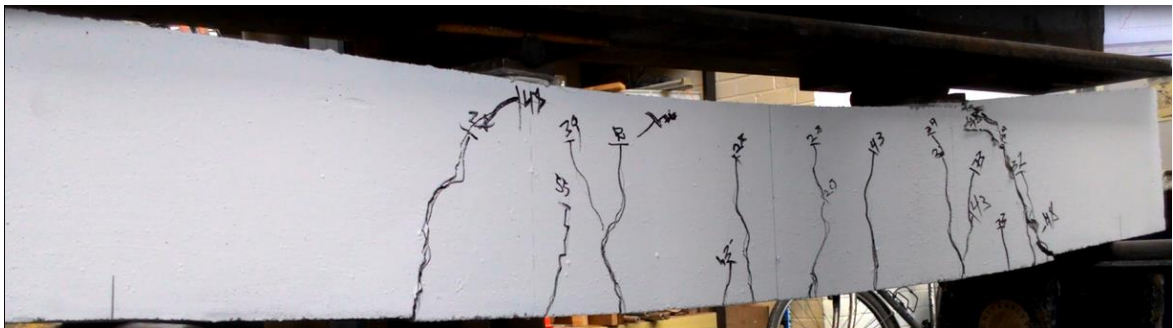
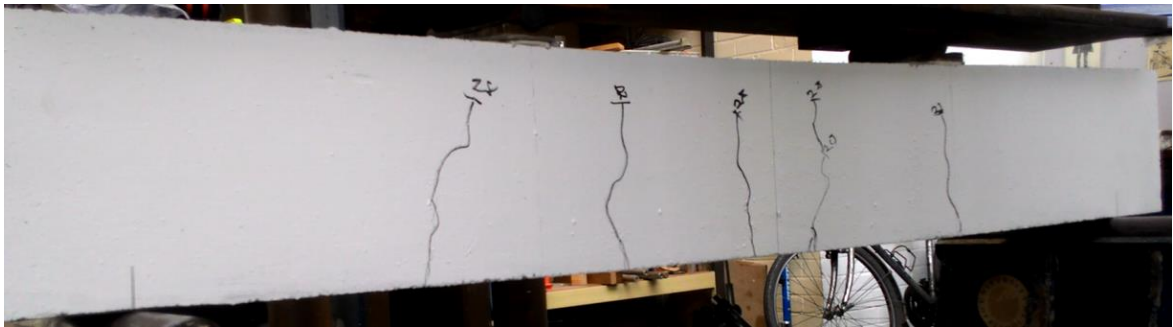
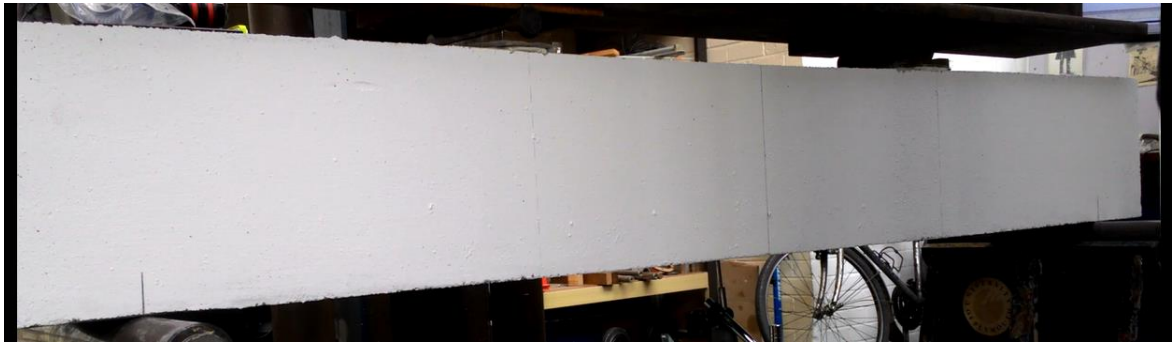

$d = h - c_{nom} - \phi_{link} - \phi_{bar}/2$
 $d = 200 - 25 - 8 - (8/2) = 163 \text{ mm}$

L=1.5	(m)
h= 200	(mm)
C _{nom} = 25	(mm)
Ø= 8	(mm)

T= Area of Steel Reinforcement x Allowable Stress= 50.5 (kN)

Area of Reinforcement=	101
Allowable Stress=	500

Materials Factor _(concrete) =	1.00	Materials Factor (Steel)=	1.00
--	------	---------------------------	------

FOR EQUILIBRIUM <u>COMPRESION MUST BE EQUAL TENSION</u>		50.5	(kN)
---	--	------	------

C=0.8*X*(materials factor*Fck/materials factor) --> X = (C*10^3)/(fck*b)	X=	15.02976	(mm)
--	----	----------	------

Statistical Factor=	1
---------------------	---

Fck=	28
------	----

Section Width (b)=	150
--------------------	-----

lambda	0.8
--------	-----

$X < 0.45d$

0.45d=	73.35
--------	-------

BM Capacity = $T*(d-0.8*X/2)$

BM Capacity =	7.93	(kNm)
----------------------	-------------	--------------

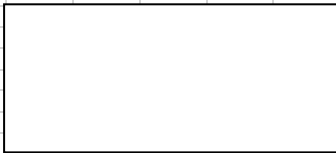

a(m)=	0.35
-------	------

E=	210000000
----	-----------

I=	0.00005625
----	------------

$\delta_{\text{Uncracked(Max)}}$ =	0.25	(mm)
------------------------------------	------	------

MB max=Pa		
P in (kN)=	22.65	(kN)
P _{Total} in (kN)=	45.30	(kN)

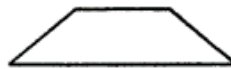
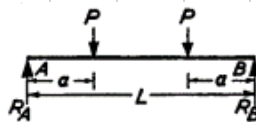

$$M_{\text{max.}} = Pa$$

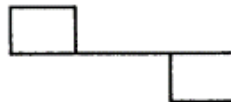

$$R_A = R_B = P$$

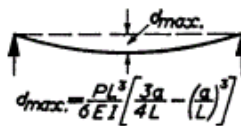

10.11

BFRP Ultimate Load Calculations

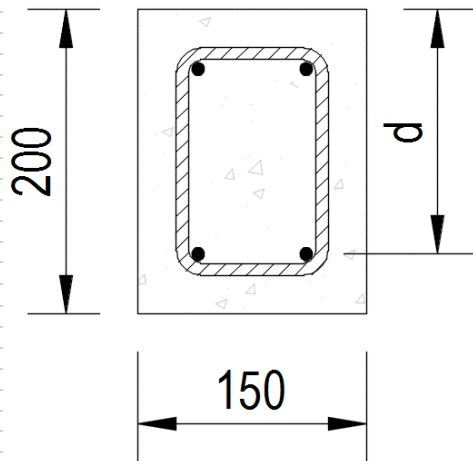

$$d = h - c_{nom} - \phi_{link} - \phi_{bar}/2$$

$d=200-25-8-(8/2)=$	163 mm
---------------------	--------

L=1.5	(m)
h= 200	(mm)
$c_{nom}=25$	(mm)
$\phi=8$	(mm)

T= Area of Steel Reinforcement x Allowable Stress=	101	(kN)
---	-----	------

Area of Reinforcement=	101
Allowable Stress=	1000
Materials Factor=	1

FOR EQUILIBRIUM <u>COMPRESION MUST BE EQUAL TENSION</u>	101	(kN)
--	-----	------

$C=0.8*X*(materials\ factor*F_{ck}/materials\ factor) \rightarrow X = (C*10^3)/(f_{ck}*b)$	X=	30.05952	(mm)
--	----	----------	------

Statistical Factor=	1
Fck=	28
Section Width (b)=	150
lambda?	0.8

0.8

$X < 0.45d$

$0.45d = 73.35$

BM Capacity = $T*(d-0.8*X/2)$

BM Capacity = 15.25	(kNm)
----------------------------	-------

BM=Pa		
--------------	--	--

P in (kN) =	43.57	(kN)
--------------------	-------	------

P_{Total} in (kN) =	87.13	(kN)
------------------------------------	-------	------

87.13

a(m) =	0.35
---------------	------

E =	50000000
------------	----------

I =	0.00005625
------------	------------

δ_{max} =	2.8	(mm)
------------------------------------	-----	------

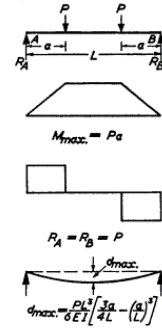

PROJECT Disseztation
 ELEMENT BFRP BEAM B4
 SHEET NO 1
 DESIGNED BY E.R.
 DATE 05/04/2017

**MARINE
 SCIENCE
 & ENGINEERING
 WITH
 PLYMOUTH
 UNIVERSITY**

School of Marine Science & Engineering
 University of Plymouth
 Reynolds Building
 Drake Circus
 Plymouth
 PL4 8AA

CALCULATIONS

OUTPUT

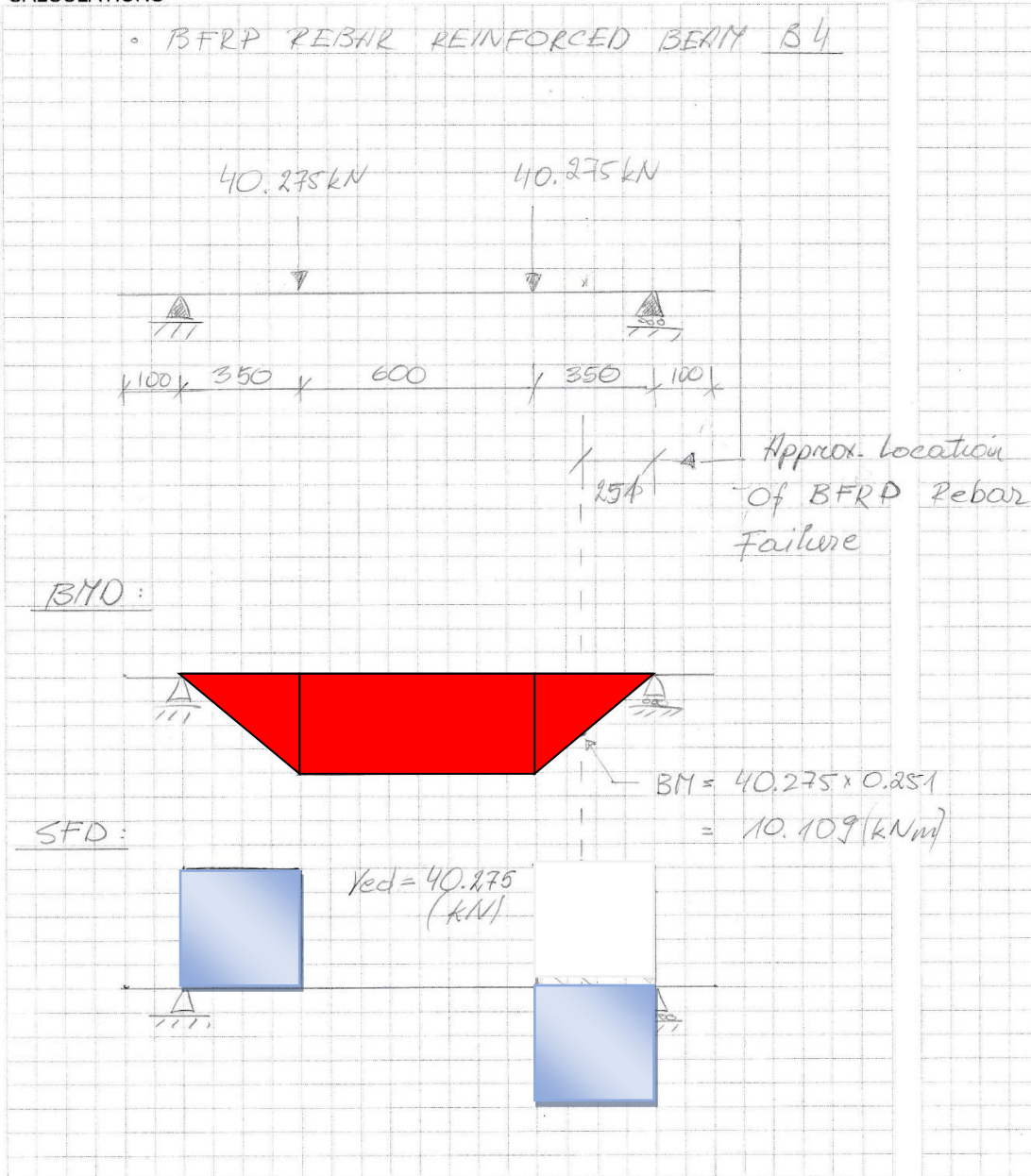

PROJECT Disseztation
 ELEMENT BFRP BEAM B4
 SHEET NO 2
 DESIGNED BY E.K
 DATE 05/04/2017

CALCULATIONS

OUTPUT

BENDING CHECK

$$K = \frac{M}{bd^2 f_{ck}}$$

$$= \frac{10.109 \times 10^6}{150 \times 163^2 \times 28}$$

$$0.0906 = 28 \text{ N/mm}^2$$

$$= 0.0906$$

$$\xi = \frac{d}{2} \left[1 + \sqrt{1 - 3.53 K'} \right] \leq 0.95 d$$

$$K \leq K'$$

$$K' = 0.168$$

$$\xi = \frac{163}{2} \left[1 + \sqrt{1 - 3.53(0.0906)} \right] \leq 0.95(163)$$

$$= 148.72 \leq 154.85$$

✓

$$\eta_s = \frac{\eta}{f_{yd} \times \xi}$$

$$f_{yd} = \frac{f_{yk}}{\gamma_m} = \frac{1000}{1}$$

$\gamma_m = 1.0$ - since materials factor is not established.

PROJECT Dissertation
ELEMENT BFRP Beam 134
SHEET NO 3
DESIGNED BY ER
DATE 05/04/2017

MARINE
SCIENCE
& ENGINEERING
WITH
PLYMOUTH
UNIVERSITY

School of Marine Science & Engineering
University of Plymouth
Reynolds Building
Drake Circus
Plymouth
PL4 8AA

CALCULATIONS

OUTPUT

• $f_{yk} = 1000$

• $f_{yd} = 1000/1$
 $= 1000 \text{ N/mm}^2$

• $A_s = \frac{10.109 \times 10^6}{1000 \times 148.72}$

$= 68 \text{ mm}^2 < A_{s \text{ prov}} (\text{Basalt}) = 101 \text{ mm}^2$

Calculation above signifies that
at point of failure BFRP had
more than enough capacity to
withstand the tension.

Thus this suggest that Beam failure did
not occur in bending.

shear check is required.

PROJECT Dissertation
ELEMENT BFRP BEAM B4
SHEET NO 4
DESIGNED BY E.R.
DATE 05/04/2017

MARINE
SCIENCE
& ENGINEERING
WITH
PLYMOUTH
UNIVERSITY

School of Marine Science & Engineering
University of Plymouth
Reynolds Building
Drake Circus
Plymouth
PL4 8AA

CALCULATIONS

OUTPUT

SHEAR CHECK

$$\tau_{ed} = \frac{V_{ed}}{b_w \cdot z}$$

$$V_{ed} = 410.275 \text{ kN}$$

$$= \frac{410.275 \cdot 10^3}{150 \cdot 148.72}$$

$$= 1.81 \text{ N/mm}^2$$

$$A_{sw} = \frac{\tau_{ed} \cdot b_w \cdot s}{f_{yd} \cdot \cot \theta}$$

$$= \frac{1.81 \cdot 120 \cdot 150}{435 \cdot 2.5}$$

$$= 30 \text{ mm}^2$$

$$\cdot 3 \text{ H'8 links provide: } 151 \text{ mm}^2 > 30 \text{ mm}^2$$

This signifies that at the point of failure shear links had more than enough capacity to withstand shear force applied.

10.13

Un-cracked Section Deflection Calculations

P_{Total} in (kN)= 8 (kN)

Length (m)= 1.3

a(m)= 0.35

E= 30000000

I= 0.00005625

δ_{max} = Variable (mm)

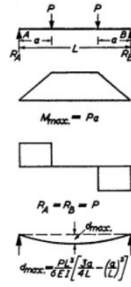

Beam B1				
Experimental Load Applied (kN)	Actual Deflection Recorded by External Gauge (mm)	Predicted Deflection (mm)	Difference (mm)	%
4	0.11	0.10	0.01	4.6
8	0.18	0.18	0.01	4.9
12	0.25	0.26	0.01	5.3
16	0.36	0.34	0.02	4.9
20	0.48	0.42	0.06	12.2

P_{Total} in (kN)= 8 (kN)

Length (m)= 1.3

a(m)= 0.35

E= 30000000

I= 0.00005625

δ_{max} = Variable (mm)

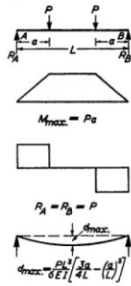

Beam B2				
Experimental Load Applied (kN)	Actual Deflection Recorded by External Gauge (mm)	Predicted Deflection (mm)	Difference (mm)	%
4	0.1	0.10	0.00	4.9
8	0.18	0.18	0.00	2.2
12	0.27	0.26	0.01	2.5
16	0.41	0.34	0.07	16.5
20	1.28	0.42	0.86	67.1

P_{Total} in (kN)= 8 (kN)

Length (m)= 1.3

a(m)= 0.35

E= 30000000

I= 0.00005625

δ_{max} = Variable (mm)



Beam B3				
Experimental Load Applied (kN)	Actual Deflection Recorded by External Gauge (mm)	Predicted Deflection (mm)	Difference (mm)	%
4	0.1	0.10	0.00	4.9
8	0.18	0.18	0.00	2.2
12	0.26	0.26	0.00	1.2
16	0.36	0.34	0.02	4.9
20	0.5	0.42	0.08	15.7

P_{Total} in (kN)= 8 (kN)

Length (m)= 1.3

a(m)= 0.35

E= 30000000

I= 0.00005625

δ_{max} = Variable (mm)

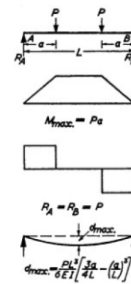

Beam B4				
Experimental Load Applied (kN)	Actual Deflection Recorded by External Gauge (mm)	Predicted Deflection (mm)	Difference (mm)	%
4	0.1	0.10	0.00	4.9
8	0.175	0.18	0.01	5.2
12	0.26	0.26	0.00	1.2
16	0.36	0.34	0.02	4.9
20	0.5	0.42	0.08	15.7

10.14 Cracked Section Deflection Calculations

neutral axis position

$$x = 30.1$$

bii second moment of area of the cracked section

$$I_{cr} = bx^3/3 + aeAs(d-x)^2$$

b=	150 mm				
ae=	5.81	E=	50 N/mm ²	Ec,eff=	8.61 kN/mm ²
As=	101				
d=	163				
I _{cr} =	11723848.4 mm ⁴				

biii Curvature Cracked Section

$$(1/r)_{cr} = M/Ec,eff I_{cr}$$

$$M = 15.25 \text{ kNm}$$

$$Ec,eff = 8.61 \text{ kN/mm}^2$$

$$(1/r)_{cr} = 1.51E-04 /mm$$

c The Average of cracked and uncracked curvature

ci $M_{cr} = f_{ctm} * (b_w h^2 / 6)$

f _{ctm} =	2.8 N/mm ²	or	Mpa
b _w =	150 mm		
h ² =	40000 mm ²		

$$M_{cr} = 2.8 \text{ kNm}$$

cii $\epsilon = 1 - \beta(M_{cr}/M)^2$

$$\beta = 1 \text{ (assumed for a single short-term load). Also for sustained loads or cyclic loading is 0.5}$$

$$\epsilon = 0.966$$

ciii $1/r = \epsilon(1/r)_{cr} + (1-\epsilon)(1/r)_{uc}$

(1/r) _{uc} =	M/Ec,eff * I _{uc}		
I _{uc} =	bd ³ /12	b= 150	d= 200
I _{uc} =	100000000 mm ⁴		

$$(1/r)_{uc} = 1.77103E-05 /mm$$

$$1/r = 1.47E-04$$

The deflection of the beam can be calculated from the total curvature using elastic bending theory which for small deflections is based on the expression:

$$M = \frac{EI d^2 y}{dx^2}$$

$$\frac{EI dy}{dx} = Mx + A$$

A – constant of integration

$$A + x = \frac{L dy}{2 dx} = 0$$

$$\therefore A = \frac{-ML}{2}$$

$$-EIy = \frac{Mx^2}{2} + Ax + B$$

B – constant of integration

$$-EIy = \frac{Mx^2}{2} - \frac{MLx}{2} + B$$

when $x = 0$ and $y = 0$

$$B = 0$$

$$y = \frac{M}{EI} \left(\frac{x^2}{2} - \frac{Lx}{2} \right)$$

Maximum Deflection Occurs at Midspan When $x = \frac{L}{2}$

$$y = -\frac{M}{EI} \left(\frac{L^2}{8} \right)$$

substitutue $-\frac{M}{EI}$ with $\frac{1}{r}$ (refer to ciii)

$$y = \frac{1}{r} \left(\frac{L^2}{8} \right)$$

$$y = 1.47 * 10^{-4} \left(\frac{1300^2}{8} \right)$$

$$y = 31.0 \text{ mm}$$

10.15 Transverse Steel Beam Deflection

Analysis undertaken using Two-Frame Structural Analysis software.

(Deflection Units in mm; External Load in kN)

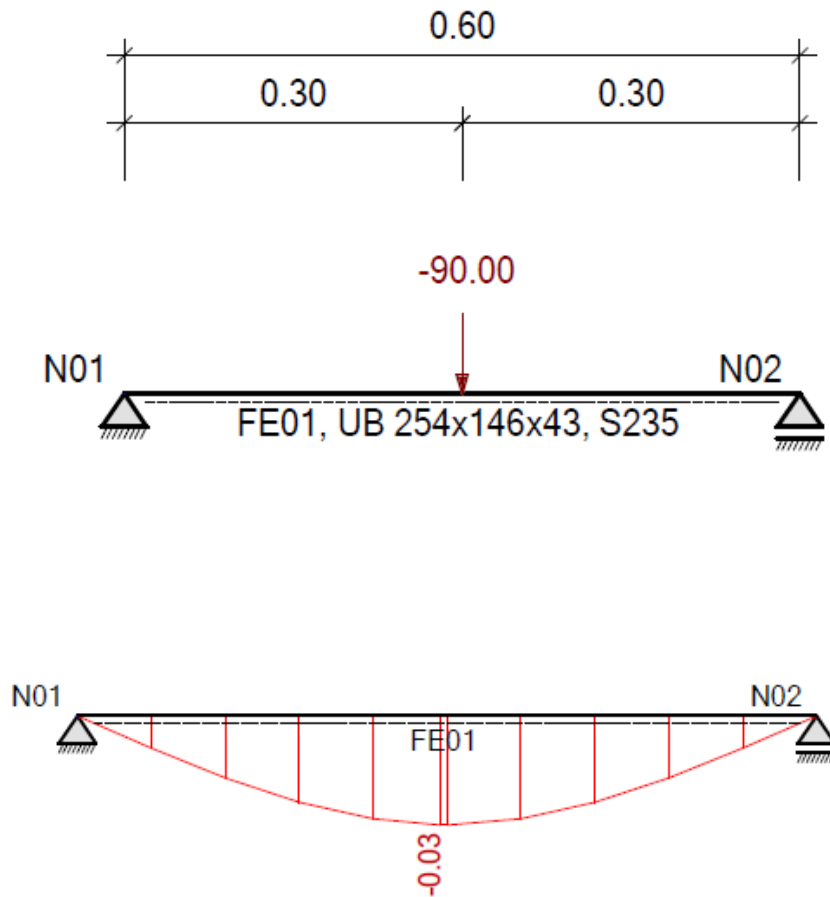

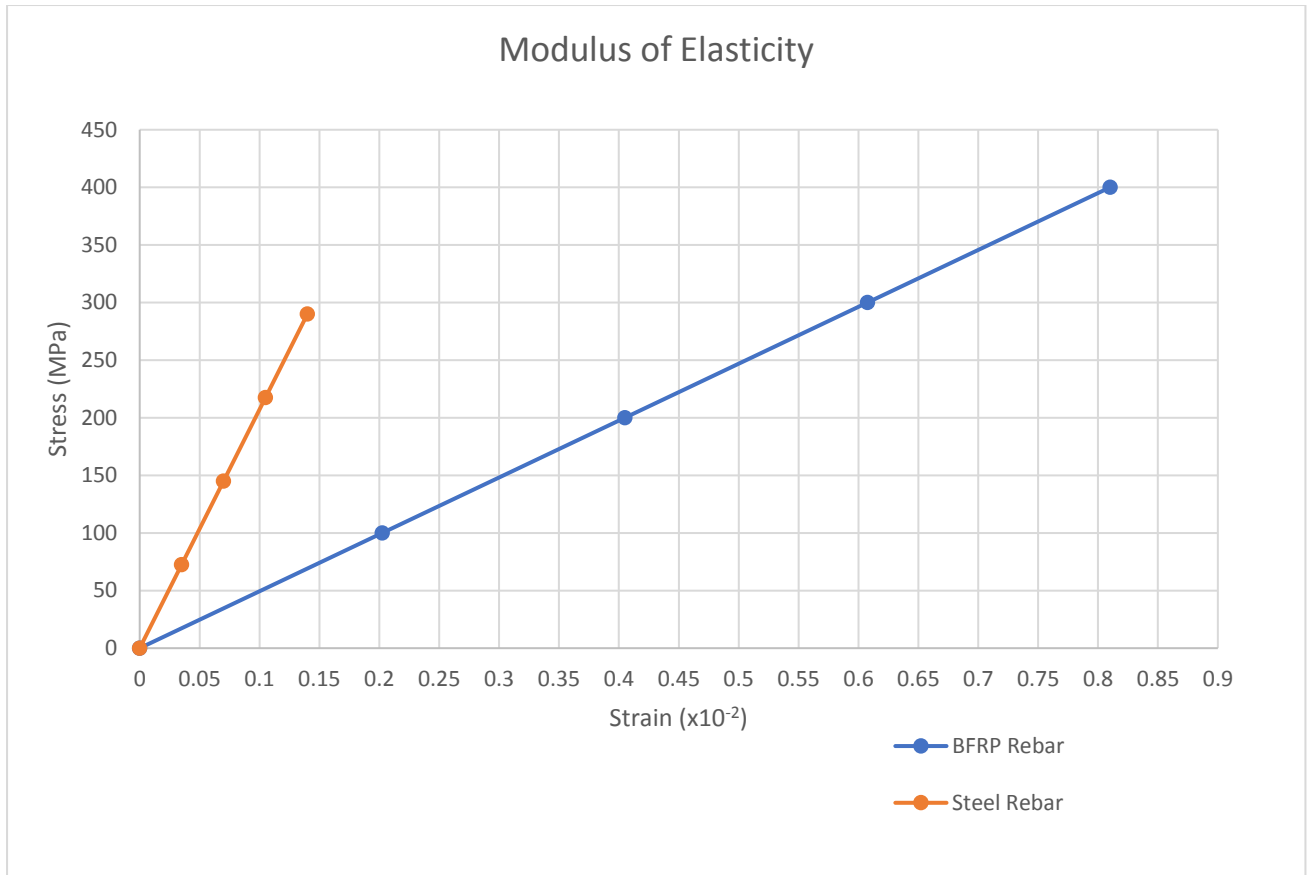

Graph 1 – Experimental Steel and BFRP Rebar Modulus of Elasticity.

Basalt Rebar Modulus of Elasticity:

$$E = \frac{\text{Stress}}{\text{Strain}} = \frac{400}{.00081} = 49383 \text{ MPa} = \mathbf{49.4 \text{ kN/mm}^2}$$

Steel Rebar Steel Modulus of Elasticity:

$$E = \frac{\text{Stress}}{\text{Strain}} = \frac{290}{.00014} = 207143 \text{ MPa} = \mathbf{207.1 \text{ kN/mm}^2}$$

