

2022

# Development of a novel antibacterial silver nanocoating to reduce nosocomial infections

Butler, James Michael

<http://hdl.handle.net/10026.1/19984>

---

<http://dx.doi.org/10.24382/1126>

University of Plymouth

---

*All content in PEARL is protected by copyright law. Author manuscripts are made available in accordance with publisher policies. Please cite only the published version using the details provided on the item record or document. In the absence of an open licence (e.g. Creative Commons), permissions for further reuse of content should be sought from the publisher or author.*

# Copyright Statement

This copy of the thesis has been supplied on condition that anyone who consults it is understood to recognise that its copyright rests with its author and that no quotation from the thesis and no information derived from it may be published without the author's prior consent.



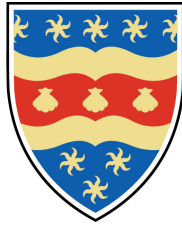

# UNIVERSITY OF PLYMOUTH

## **DEVELOPMENT OF A NOVEL ANTIBACTERIAL SILVER NANOCOATING TO REDUCE NOSOCOMIAL INFECTIONS**

by

**JAMES MICHAEL BUTLER**

A thesis submitted to the University of Plymouth  
in partial fulfilment for the degree of

**DOCTOR OF PHILOSOPHY**

School of Engineering, Computing and Mathematics

November 2022



# Acknowledgements

I am grateful to my project supervisors: Dr Alex Besinis, Prof Mat Upton, Dr Lewis Jones, and Dr Alistair Cree for the opportunity to complete a PhD. I must also thank the School of Engineering, Computing and Mathematics for fully funding my PhD studentship including a 4-month stipend extension due to the COVID-19 pandemic, and the School of Biomedical Sciences for use of the biomedical research labs at Derriford and support during my project.

Special thanks must go to Prof Mat Upton for his mentorship, advice, and generosity with time.

Thank you to the technical staff who have guided and advised me across different disciplines and techniques: Dr Paul Waines, Mr Matt Emery, Dr Andy Fisher, Dr Rob Clough, and Dr Jeremy Clark.

Thank you Dr Ben O'Driscoll, for assistance in completing Raman spectroscopy – and for the chats about the trials and tribulations of doing a PhD!

Thank you Dr James Edwards, my Expert Commentator, for a valuable broad discussion of my project's aims, data and progression during my Transfer milestone.

Thank you Mr Pete Brennan and Mr Simon Knight, Facilities staff at the John Bull Building and Derriford Research Facility, for the support and chats during my project, for keeping the buildings running, and for efficiently facilitating the *in situ* work described in Chapter 5. I am also grateful to Estates and R&D staff at University Hospitals Plymouth NHS Trust for facilitating collection of hospital sink trap samples.

Thanks to all members of the Upton group over the years – it's been a blast! Particularly: Dr Michelle Vang Mouritzen, Mr Sean Kelly, Dr Matt Koch, Miss Jazz Conway, Dr Katie Muddiman, and Dr Grant January.

Thanks must go to Dr Martin Coath for providing instructions and minimal examples which helped me to use  $\LaTeX$  to typeset this thesis.

I am grateful to the many people who have offered advice and opportunities over the years which have, step by step, led me to this goal. Particular thanks should go to my supervisors from previous projects: Dr Claudia Barros, Dr Phil Warburton, and Dr Andy Foey.

Finally, I must acknowledge my partner of eight years, Lewis. Thank you for the support, for listening to me drone on about my work, for asking questions, and for putting up with all the pitfalls of me being a PhD student. This thesis is dedicated to you.



# Statement on the COVID-19 pandemic

In March 2020, the UK entered its first lockdown in response to the COVID-19 pandemic. This lockdown began 18 months into my 36-month PhD project and required all laboratory research to stop, and for me and others to work from home.

A phased reopening began at the University of Plymouth's Derriford Research Facility in June 2020, first with users limited to morning or afternoon shifts of four hours per day. The University's city centre campus, the site for all materials and engineering work, remained closed. I am grateful that, on 19th June 2020, I was given one-off permission to access the city centre campus to collect vital materials to facilitate the resumption of some aspects of my research project.

City centre campus re-occupation and the extension of the Derriford Research Facility's opening hours came in August 2020.

In addition to those mentioned in the Acknowledgements, I am grateful to the many people involved in reopening the laboratories following the initial COVID-19 lockdown for their hard work and understanding of the importance of returning to physical work for PhD students such as myself. I am also thankful that despite ongoing legal restrictions with subsequent waves of COVID-19 infections, access to facilities was not curtailed in the same way again.

I include this statement in this thesis to provide additional context to the work described. My memories of my PhD will always be closely associated with memories of the COVID-19 pandemic - which we once referred to as 'unprecedented' but now as 'the new normal'. I do not give this short description of the pandemic's timeline to give any excuse or mitigation, but rather I simply thought it would be strange to complete this thesis and not refer to what has been a majorly impactful part of my time as a PhD student.





# Author declaration

At no time during the registration for the degree of Doctor of Philosophy has the author been registered for any other University award without prior agreement of the Doctoral College Quality Sub-Committee. Work submitted for this research degree at the University of Plymouth has not formed part of any other degree either at the University of Plymouth or at another establishment. This study was financed with the aid of a studentship from the School of Engineering, Computing and Mathematics, Faculty of Science and Engineering, University of Plymouth.

## Publications:

**Butler, J., Kelly, S. D., Muddiman, K. J., Besinis, A. and Upton, M.** Hospital sink traps as a potential source of the emerging multidrug-resistant pathogen *Cupriavidus pauculus*: characterization and draft genome sequence of strain MF1. *Journal of Medical Microbiology*. 2022. DOI 10.1099/jmm.0.001501.

## Publications in preparation:

**Butler, J., Jones, L., Upton, M., & Besinis, A.** Evaluating the antibacterial efficacy of a silver nanocomposite surface coating in a sink trap model and a real-world setting. *Manuscript in preparation*.

**Butler, J., Handy, R. D., Upton, M., & Besinis, A.** Review of Antimicrobial Nanocoatings in Medicine and Dentistry: Mechanisms of action, biocompatibility performance, clinical Concerns, and benefits compared to antibiotics. *Manuscript in preparation*.

## Posters and conference presentations:

**Academy of Medical Sciences INSPIRE Event, Plymouth, UK.** Advances in Interdisciplinary Research in Medical Sciences. Poster presentation: *Nanotechnology as an Antimicrobial Strategy in Medicine and Dentistry*. April 2019.

**British Council Researcher Links Workshop, Lancaster, UK.** Patient-tailored Biomaterials for Tissue Regeneration, Combating Microbial Contamination and Drug Delivery. Poster presentation: *Development of Novel Antibacterial Coatings to Reduce Nosocomial Infections*. October 2019.

**Biofilm Science and Technology Annual Meeting, USA.** Montana State University Center for Biofilm Engineering meeting on Biofilms and Antimicrobials, Field Studies, Biofilm Methods, Biofilm Dynamics, and Paths Forward. Event moved online due to the COVID-19 pandemic. Poster presentation: *Development of Novel Antibacterial Coatings to Reduce Nosocomial Infections*. July 2020.

**Young Microbiologists Symposium, Southampton, UK.** The 6th Young Microbiologists Symposium on Microbe Signalling, Organisation and Pathogenesis. Event moved online due to the COVID-19 pandemic. Poster and oral presentation: *Development of a Novel Antibiofilm Silver Nanocoating to Reduce Nosocomial Infections*. August 2020.

**Faculty of Health Postgraduate Research Showcase, Plymouth, UK.** University of Plymouth Research Festival 2021. Event moved online due to the COVID-19 pandemic. Oral presentation: *Development of a Novel Antibacterial Silver Nanocoating to Reduce Nosocomial Infections*. Won overall prize for Best Oral Presentation and invited to judge this category the following year. June 2021.

Word count for the main body of this thesis: **32,036**

Signed:  \_\_\_\_\_

Date: 24th June 2022

# Abstract

## **Development of a novel antibacterial silver nanocoating to reduce nosocomial infections**

*James Michael Butler*

Nosocomial infections (those that are hospital-acquired) lead to patient morbidity and mortality, and are further complicated by the growing problem of antimicrobial resistance. Wastewater plumbing systems (WPS) are bacterial reservoirs and vehicles for bacterial transmission. Sink traps form a barrier between users and the WPS, but breaches can lead to contamination and have been implicated in outbreaks of infections. This project sought to address the need for a novel antimicrobial nanocoating to reduce bacterial colonisation and biofilm formation in sink traps.

A nanocoating was developed by embedding silver nanoparticles in a matrix of commercially-available and low-cost pipe cement, applied to unplasticised polyvinyl chloride. Material characterisation and nanotopography imaging revealed that roughness was increased by surface grinding, with nanotopography images showing the troughs produced, and high silver stability was evident with very low dissolution under controlled dialysis experiment conditions.

Culture-dependent and -independent techniques were used to characterise the bacteria present in hospital sink traps, revealing certain dominant genera such

as *Citrobacter*, *Pseudomonas* and *Serratia*. Sequencing of 16S rDNA from sink traps has previously been an under-reported area. A bacterial isolate of interest, *Cupriavidus pauculus* MF1, was further investigated and found to be multidrug-resistant with biofilm formation comparable to *Pseudomonas aeruginosa*. Whole genome sequencing, producing a hybrid assembly of short- and long-reads, allowed annotation of a number of antibiotic and metal resistance and virulence factor genes of interest, supporting the suggestion that awareness should be increased for this and other opportunistic pathogens in hospital sink traps.

Silver nanocoatings demonstrated potent antiplanktonic and antibiofilm activity against the nosocomial pathogens *Pseudomonas aeruginosa*, *Acinetobacter baumannii* and *Enterococcus faecalis*.

Novel, more realistic experimental conditions were developed, first using a hospital sink trap community to colonise a benchtop model sink trap system. Antibiofilm activity was evident over long time periods, up to 11 days, but waned by day 25. Placement of silver nanocoated specimens in real-world sink traps in two university buildings provided little overall evidence of a consistent antibiofilm effect. Follow-up *in vitro* experiments using hospital and university building sink trap communities confirmed that the silver nanocoating was active against those same polymicrobial communities. It is possible that certain realistic environmental conditions mask the surface of nanocoatings and limit their activity, with relevance to antimicrobial nanocoating development in plumbing systems and other environments. The results indicate that there can be significant discord between *in vitro* and *in situ* experiments, emphasising the need for novel antimicrobial nanocoatings to be evaluated in real-world settings.

# Contents

<b>Acknowledgements</b>	<b>5</b>
<b>Statement on the COVID-19 pandemic</b>	<b>7</b>
<b>Author's declaration</b>	<b>9</b>
<b>Abstract</b>	<b>11</b>
<b>List of Figures</b>	<b>19</b>
<b>List of Tables</b>	<b>22</b>
<b>Nomenclature</b>	<b>23</b>
<b>1 General introduction</b>	<b>31</b>
1.1 Antimicrobial resistance: background, solutions and approaches	31
1.1.1 Definitions and background . . . . .	31
1.1.2 Impact . . . . .	32
1.1.3 Infection prevention and control as a solution . . . . .	33
1.1.4 The 'One Health' approach to antimicrobial resistance . .	34
1.2 Routes of acquisition of infection . . . . .	37
1.3 Nosocomial infections . . . . .	38
1.3.1 Definitions . . . . .	38
1.3.2 Significance and impact . . . . .	38
1.3.3 Hospital wastewater plumbing systems . . . . .	42
1.4 Surface colonisation: The role of biofilm . . . . .	48
1.4.1 Definition and composition . . . . .	48
1.4.2 Formation and development . . . . .	49
1.4.3 Clinical relevance . . . . .	52
1.5 Nanomaterials . . . . .	53

1.5.1	Definitions and background . . . . .	53
1.5.2	Nanomaterials as antimicrobials . . . . .	54
1.5.3	Antimicrobial silver nanocoatings . . . . .	56
1.6	Bacterial resistance to silver nanoparticles . . . . .	57
1.7	Hypothesis . . . . .	60
1.8	Aims . . . . .	60
1.9	Objectives . . . . .	60
1.10	Significance . . . . .	61
<b>2</b>	<b>Investigation of hospital sink traps</b>	<b>63</b>
2.1	Introduction . . . . .	63
2.1.1	Aims . . . . .	69
2.1.2	Objectives . . . . .	69
2.2	Materials and methods . . . . .	70
2.2.1	Sample collection . . . . .	70
2.2.2	Molecular characterisation of the microbial flora recovered from the archived hospital sink trap by MinION 16S rDNA amplicon sequencing . . . . .	71
2.2.2.1	DNA extraction from the archived sink trap swab sample . . . . .	71
2.2.2.2	MinION 16S rDNA amplicon sequencing . . . . .	72
2.2.2.3	Bioinformatic analysis . . . . .	73
2.2.3	Molecular characterisation of the microbial flora recovered from a pooled hospital sink trap sample by Illumina 16S rDNA amplicon sequencing . . . . .	73
2.2.3.1	DNA extraction from hospital sink trap swab samples . . . . .	73
2.2.3.2	Illumina 16S rDNA amplicon sequencing and analysis . . . . .	74
2.2.4	Bacterial culture from hospital sink traps . . . . .	75
2.2.4.1	Bacterial recovery without selection . . . . .	75
2.2.4.2	Bacterial recovery with selection . . . . .	75
2.2.4.3	DNA extraction, amplification and sequencing of 16S rDNA of single isolates . . . . .	76

## CONTENTS

---

2.2.5	Further investigation of a <i>Cupriavidus</i> sp. isolate from a hospital sink trap . . . . .	77
2.2.5.1	Draft genome determination of the <i>Cupriavidus</i> sp. isolate . . . . .	77
2.2.5.2	Hybrid genome assembly and annotation . . . . .	79
2.2.5.3	Antimicrobial susceptibility testing of the <i>Cupriavidus</i> sp. isolate . . . . .	79
2.2.5.4	<i>Galleria mellonella</i> infection to determine median lethal dose of the <i>Cupriavidus</i> sp. isolate . . . . .	80
2.2.5.5	<i>Cupriavidus</i> sp. biofilm formation compared to <i>Pseudomonas aeruginosa</i> PAO1 . . . . .	82
2.2.6	Statistical analysis . . . . .	83
2.3	Results . . . . .	83
2.3.1	Hospital sink trap 16S rDNA amplicon survey . . . . .	83
2.3.1.1	Molecular characterisation of bacterial flora from an archived hospital sink trap using MinION 16S rDNA amplicon sequencing . . . . .	83
2.3.1.2	Characterisation of bacterial flora from pooled hospital sink trap swabs using Illumina 16S rDNA amplicon sequencing . . . . .	85
2.3.2	Bacterial recovery from hospital sink traps . . . . .	86
2.3.3	Further investigation of <i>Cupriavidus pauculus</i> strain MF1 . . . . .	87
2.3.3.1	Initial isolation and identification . . . . .	87
2.3.3.2	Draft whole genome sequence . . . . .	88
2.3.3.3	Antimicrobial susceptibility testing . . . . .	90
2.3.3.4	Median lethal dose in <i>Galleria mellonella</i> larvae . . . . .	93
2.3.3.5	Biofilm formation compared to <i>Pseudomonas aeruginosa</i> PAO1 . . . . .	94
2.4	Discussion . . . . .	96
2.4.1	16S rDNA sequencing of hospital sink trap samples . . . . .	96
2.4.2	Bacterial recovery from hospital sink traps . . . . .	100
2.4.3	<i>Cupriavidus pauculus</i> MF1 . . . . .	102
2.5	Conclusion . . . . .	108



<b>3</b>	<b>Nanocoating development and characterisation</b>	<b>111</b>
3.1	Introduction . . . . .	111
3.1.1	Aims . . . . .	116
3.1.2	Objectives . . . . .	116
3.2	Materials and methods . . . . .	117
3.2.1	Substrate material selection . . . . .	117
3.2.2	Specimen preparation . . . . .	117
3.2.3	Preparation and application of nanocoatings . . . . .	118
3.2.4	Surface roughness . . . . .	120
3.2.5	Raman spectroscopy . . . . .	120
3.2.6	Nanocoating stability determination by dialysis assay . . .	121
3.3	Results . . . . .	123
3.3.1	Surface roughness . . . . .	123
3.3.2	Surface nanotopography . . . . .	124
3.3.3	Raman spectroscopy . . . . .	126
3.3.4	Nanocoating stability . . . . .	126
3.4	Discussion . . . . .	129
3.4.1	Surface roughness and nanotopography . . . . .	129
3.4.2	Characterisation of the nanocoating surface . . . . .	130
3.4.3	Stability of silver within the nanocoating . . . . .	131
3.5	Conclusion . . . . .	133
<b>4</b>	<b>Antibacterial efficacy of the silver nanocoating <i>in vitro</i> against a panel of nosocomial pathogens</b>	<b>135</b>
4.1	Introduction . . . . .	135
4.1.1	Pathogens relevant to nosocomial infections . . . . .	138
4.1.1.1	ESKAPE pathogen group . . . . .	138
4.1.1.2	<i>Pseudomonas aeruginosa</i> . . . . .	138
4.1.1.3	<i>Acinetobacter baumannii</i> . . . . .	141
4.1.1.4	<i>Enterococcus faecalis</i> . . . . .	142
4.1.2	Aims . . . . .	143
4.1.3	Objectives . . . . .	143

## CONTENTS

---

4.2	Materials and methods . . . . .	144
4.2.1	Bacterial strains . . . . .	144
4.2.2	General experimental setup . . . . .	144
4.2.3	Crystal violet solubilisation assay of biomass on uPVC discs . . . . .	145
4.2.4	Biofilm removal . . . . .	145
4.2.5	Resazurin assay . . . . .	146
4.2.6	Minimum bactericidal concentration assay . . . . .	147
4.2.7	Quantification of nanocoating antibacterial efficacy through disc exposure experiments . . . . .	147
4.2.8	Inductively coupled plasma optical emission spectrometry	148
4.3	Results . . . . .	150
4.3.1	Optimisation of methods . . . . .	150
4.3.1.1	Use of the crystal violet solubilisation assay to quantify biofilm formation on uPVC discs . . . . .	150
4.3.1.2	Comparison of biofilm removal methods . . . . .	152
4.3.1.3	Resazurin assay for <i>in situ</i> biofilm quantification	154
4.3.2	Minimum bactericidal concentration of silver in varying media conditions against <i>P. aeruginosa</i> and <i>A. baumannii</i>	156
4.3.3	Antibiofilm activity of the silver nanocoating against <i>P. aeruginosa</i> , <i>A. baumannii</i> and <i>E. faecalis</i> . . . . .	157
4.3.4	Antiplanktonic activity of the silver nanocoating against <i>P. aeruginosa</i> , <i>A. baumannii</i> , and <i>E. faecalis</i> . . . . .	160
4.3.5	Release of silver from the nanocoating following disc exposure experiments with bacteria . . . . .	161
4.3.6	Release of silver from the silver nanocoating following sonication . . . . .	162
4.4	Discussion . . . . .	163
4.4.1	Optimisation of methods . . . . .	163
4.4.2	Effect of media conditions on the bactericidal activity of silver . . . . .	167
4.4.3	Antibacterial activity of the silver nanocoating <i>in vitro</i> . . . . .	168
4.4.4	Nanocoating stability . . . . .	169
4.4.5	Use of <i>in vitro</i> assessment of nanocoating efficacy . . . . .	171

4.5	Conclusion . . . . .	172
<b>5</b>	<b>Antibiofilm efficacy of the silver nanocoating against a hospital sink trap community in an artificial laboratory benchtop sink trap rig and <i>in situ</i> in real-world sink traps</b>	<b>175</b>
5.1	Introduction . . . . .	175
5.1.1	Aims . . . . .	178
5.1.2	Objectives . . . . .	178
5.2	Materials and methods . . . . .	179
5.2.1	Disc setup . . . . .	179
5.2.2	Hospital sink trap community . . . . .	181
5.2.3	Laboratory benchtop model sink trap system . . . . .	181
5.2.3.1	Colonisation . . . . .	181
5.2.3.2	Experiments . . . . .	181
5.2.4	<i>In situ</i> testing of nanocoatings in real-world sink traps . . . . .	184
5.2.4.1	Study site . . . . .	184
5.2.4.2	Study design . . . . .	185
5.2.5	Quantification of antibacterial efficacy . . . . .	186
5.2.6	Characterisation of the university building sink trap bacterial community by 16S rDNA amplicon sequencing . . . . .	186
5.2.7	Disc exposure experiments . . . . .	187
5.3	Results . . . . .	188
5.3.1	Antibacterial efficacy of the silver nanocoating <i>in vitro</i> against hospital sink trap bacteria . . . . .	188
5.3.2	Antibiofilm efficacy of the silver nanocoating in a benchtop sink trap model . . . . .	189
5.3.3	Characterisation of university building sink trap community by 16S rDNA amplicon sequencing . . . . .	191
5.3.4	Antibiofilm efficacy of the silver nanocoating in real-world university building sink traps <i>in situ</i> . . . . .	193
5.3.5	Antibacterial efficacy of the silver nanocoating <i>in vitro</i> against university building sink trap community . . . . .	195
5.4	Discussion . . . . .	197

## CONTENTS

---

5.4.1	Challenge of nanocoatings with single- versus multi-species bacterial inocula . . . . .	198
5.4.2	Discord between laboratory-based <i>in vitro</i> and real-world <i>in situ</i> experiments . . . . .	199
5.4.3	Characterisation of the university building sink trap bacterial community . . . . .	201
5.5	Conclusion . . . . .	203
<b>6</b>	<b>General discussion and conclusions</b>	<b>205</b>
6.1	Contribution to knowledge . . . . .	205
6.2	The future of antimicrobial nanocoating research . . . . .	207
	<b>References</b>	<b>209</b>
	<b>Bound copies of published papers</b>	<b>277</b>
	Butler et al. (2022): Hospital sink traps as a potential source of the emerging multidrug-resistant pathogen <i>Cupriavidus pauculus</i> : characterization and draft genome sequence of strain MF1 . . . . .	279
<b>A</b>	<b>Investigation of hospital sink traps</b>	<b>291</b>
A.1	Media preparation . . . . .	291
A.2	16S rDNA amplicon sequencing . . . . .	292
A.2.1	Quality control of MinION 16S rDNA amplicon sequencing of swabs from a hospital sink trap collected in 2017 . . . . .	292
A.2.2	Quality control of Illumina 16S rDNA amplicon sequencing of hospital sink trap swabs collected in 2021 . . . . .	294
<b>B</b>	<b>Nanocoating development and characterisation</b>	<b>295</b>
B.1	Pipe cement composition . . . . .	295
<b>C</b>	<b>Antibiofilm efficacy of the silver nanocoating against a hospital sink trap community in a model system and <i>in situ</i> in real-world sink traps</b>	<b>297</b>
C.1	Faculty Research Ethics and Integrity Committee approval . . . . .	297
C.2	Integrated Research Application System (IRAS) application form . . . . .	299
C.3	Approval from the Health Research Authority . . . . .	329



# List of Figures

1.1	Spread of resistant bacteria between people, animals and the environment . . . . .	36
1.2	Diagram of a bottle-style sink trap . . . . .	42
1.3	Hospital sink showing handwashing only sign . . . . .	44
1.4	Schematic of biofilm formation, maturation and dispersal . . . . .	50
1.5	Relative size of nanomaterials . . . . .	53
1.6	Antibacterial mechanisms of nanoparticles . . . . .	55
1.7	Genetic basis of bacterial resistance to nanoparticles . . . . .	59
2.1	16S rDNA amplicon survey of an archived hospital sink trap . . . . .	84
2.2	16S rDNA amplicon survey of pooled and enriched hospital sink trap swabs . . . . .	85
2.3	<i>Cupriavidus pauculus</i> MF1 biofilm formation . . . . .	95
3.1	DLVO theory of bacterial adhesion . . . . .	112
3.2	Illustration of surface roughness parameters . . . . .	115
3.3	Engineering drawing of uPVC disc . . . . .	118
3.4	Surface roughness of nanocoatings . . . . .	123
3.5	Surface nanotopography images . . . . .	125
3.6	Raman spectra of nanocoatings . . . . .	127
3.7	Dialysis assay of nanocoatings . . . . .	128
4.1	Reduction steps of resazurin . . . . .	137
4.2	Overview of disc exposure experiment workflow . . . . .	149
4.3	Adhered biomass of <i>Pseudomonas aeruginosa</i> on uncoated uPVC discs measured by crystal violet solubilisation assay . . . . .	150
4.5	Comparison of biofilm removal methods . . . . .	153
4.6	Resazurin assay of <i>in situ</i> <i>Acinetobacter baumannii</i> biofilm . . . . .	154
4.7	Kinetic resazurin assay with planktonic bacteria . . . . .	155
4.8	<i>In vitro</i> antibiofilm activity of silver nanocoated discs . . . . .	157

## LIST OF FIGURES

---

4.9	<i>In vitro</i> broth regrowth assay of biofilm cells . . . . .	158
4.10	Extent of biofilm formation on discs determined <i>in situ</i> using the resazurin assay . . . . .	159
4.11	Antibacterial activity of coated discs against three representative organisms in the planktonic phase . . . . .	160
4.12	Silver release during disc exposure experiments . . . . .	161
4.13	Silver release during sonication of discs to liberate biofilm . . . . .	162
5.1	Appearance of silver nanocoated discs with central holes melted for mounting on nichrome wires . . . . .	179
5.2	Appearance of disc setup mounted on nichrome wires . . . . .	180
5.3	Laboratory benchtop sink trap model system . . . . .	183
5.4	Site of sink traps 1 and 2 . . . . .	184
5.5	Site of sink traps 3 and 4 . . . . .	185
5.6	Antibacterial efficacy of silver nanocoating against hospital sink trap bacteria <i>in vitro</i> . . . . .	188
5.7	Antibiofilm efficacy of silver nanocoating against hospital sink trap bacteria in a benchtop sink trap model . . . . .	190
5.8	16S rDNA amplicon survey of university building sink traps . . . . .	192
5.9	Antibiofilm efficacy of silver nanocoating in real-world sink traps . . . . .	194
5.10	Antibacterial efficacy of silver nanocoating against the university building sink trap community <i>in vitro</i> . . . . .	196

# List of Tables

1.1	Research needed within the ‘One Health’ approach to AMR . . .	35
2.1	Bacteria previously cultured from hospital wastewater plumbing systems . . . . .	64
2.2	Bacteria cultured from hospital sink traps . . . . .	87
2.3	<i>Cupriavidus pauculus</i> MF1 draft genome characteristics . . . . .	88
2.4	<i>Cupriavidus pauculus</i> MF1 genes of interest . . . . .	90
2.5	Minimum inhibitory concentrations of antibiotics against <i>Cupriavidus pauculus</i> MF1 . . . . .	91
2.6	Correlation of phenotypic resistance and genotypic resistance determinants in <i>Cupriavidus pauculus</i> MF1 . . . . .	93
4.1	Minimum bactericidal concentrations of silver nanoparticles and silver nitrate in different media . . . . .	156
A.1	Components of Reasoner’s 2A (R2A) broth . . . . .	291
A.2	Quality control statistics from MinION 16S rDNA amplicon sequencing of hospital sink trap swabs . . . . .	292
A.3	Results of MinION-based 16S rDNA sequencing of an archived hospital sink trap . . . . .	293
A.4	Quality control statistics from Illumina 16S rDNA amplicon sequencing of hospital sink trap swabs . . . . .	294
B.1	Composition of pipe cement . . . . .	295



*LIST OF TABLES*

---

# Nomenclature

<i>A. baumannii</i>	<i>Acinetobacter baumannii</i>
<i>ABR</i>	Antibiotic resistance
<i>Ag</i>	Silver
<i>AIDS</i>	Acquired immunodeficiency syndrome
<i>AMR</i>	Antimicrobial resistance
<i>ANI</i>	Average nucleotide identity
<i>ANOVA</i>	Analysis of variance
<i>ARG</i>	Antibiotic resistance gene
<i>ATCC</i>	American Type Culture Collection
<i>ATW</i>	Autoclaved tap water
<i>BLAST</i>	Basic Local Alignment Search Tool
<i>bp</i>	Base pair
<i>BSI</i>	Bloodstream infection
<i>C. difficile</i>	<i>Clostridioides difficile</i>
<i>C. pauculus</i>	<i>Cupriavidus pauculus</i>
<i>CAD</i>	Computer-aided design
<i>CDC</i>	Centers for Disease Control and Prevention
<i>CDS</i>	Coding sequences
<i>CFTR</i>	Cystic fibrosis transmembrane conductance regulator
<i>CFU</i>	Colony-forming unit
<i>CF</i>	Cystic fibrosis
<i>CLIMB</i>	Cloud Infrastructure for Big Data Microbial Bioinformatics

## NOMENCLATURE

---

<i>COVID-19</i>	Coronavirus disease 2019
<i>CRE</i>	Carbapenem-resistant <i>Enterobacteriaceae</i>
<i>CV</i>	Crystal violet
<i>DDH</i>	DNA-DNA hybridisation
<i>DLVO</i>	Derjaguin-Landau-Verwey-Overbeek
<i>DNA</i>	Deoxyribonucleic acid
<i>dsDNA</i>	Double-stranded deoxyribonucleic acid
<i>E. coli</i>	<i>Escherichia coli</i>
<i>E. faecalis</i>	<i>Enterococcus faecalis</i>
<i>EDTA</i>	Ethylenediaminetetraacetic acid
<i>EPS</i>	Extracellular polymeric substances
<i>ESBL</i>	Extended-spectrum $\beta$ -lactamase
<i>EUCAST</i>	European Committee on Antimicrobial Susceptibility Testing
<i>FDA</i>	Food and Drug Administration
<i>FEPA</i>	Federation of European Producers of Abrasives
<i>G. mellonella</i>	<i>Galleria mellonella</i>
<i>GFP</i>	Green fluorescent protein
<i>GNBSI</i>	Gram-negative bloodstream infection
<i>HAI</i>	Hospital-acquired infection; solely denoting infections acquired in hospital settings through either medical intervention or passive environmental exposure
<i>HCAI</i>	Healthcare-associated infection; denoting infections acquired in hospital settings as well as in other healthcare environments such as general practice surgeries, hospices, and nursing/care homes
<i>HGT</i>	Horizontal gene transfer

## NOMENCLATURE

---

<i>HIV</i>	Human immunodeficiency virus
<i>HRA</i>	Health Research Authority
<i>Iatrogenic infection</i>	An infection acquired as the result of a medical intervention such as a surgical operation
<i>ICE</i>	Integrative conjugative element
<i>ICP-MS</i>	Inductively coupled plasma mass spectrometry
<i>ICP-OES</i>	Inductively coupled plasma optical emission spectroscopy
<i>ICU</i>	Intensive care unit
<i>IMS</i>	Industrial methylated spirits
<i>IPC</i>	Infection prevention and control
<i>IRAS</i>	Integrated Research Application System
<i>IUPAC</i>	International Union of Pure and Applied Chemistry
<i>K. oxytoca</i>	<i>Klebsiella oxytoca</i>
<i>K. pneumoniae</i>	<i>Klebsiella pneumoniae</i>
<i>LB</i>	Lysogeny broth
<i>LD<sub>50</sub></i>	Median lethal dose
<i>LOD</i>	Limit of detection
<i>LPS</i>	Lipopolysaccharide
<i>LRTI</i>	Lower respiratory tract infection
<i>MBC</i>	Minimum bactericidal concentration
<i>MIC</i>	Minimum inhibitory concentration
<i>MLST</i>	Multi-locus sequence typing
<i>MRG</i>	Metal resistance gene
<i>MRSA</i>	Methicillin-resistant <i>Staphylococcus aureus</i>

## NOMENCLATURE

---

<i>MSSA</i>	Methicillin-sensitive <i>Staphylococcus aureus</i>
<i>NaOCl</i>	Sodium hypochlorite
<i>NCBI</i>	National Center for Biotechnology Information
<i>NCIMB</i>	National Collection of Industrial Food and Marine Bacteria
<i>NCTC</i>	National Collection of Type Cultures
<i>NGS</i>	Next generation sequencing
<i>NHS</i>	National Health Service
<i>Nosocomial infection</i>	Broadly interchangeable with hospital-acquired infection
<i>OD<sub>600</sub></i>	Optical density at 600 nm
<i>ONT</i>	Oxford Nanopore Technologies
<i>Opportunistic infections</i>	Those infections that occur more frequently or are more severe in people with compromised immune systems and/or comorbidities
<i>OTU</i>	Operational taxonomic unit
<i>P. aeruginosa</i>	<i>Pseudomonas aeruginosa</i>
<i>PCR</i>	Polymerase chain reaction
<i>PC</i>	Pipe cement
<i>PK-PD</i>	Pharmacokinetic-pharmacodynamic
<i>PMMA</i>	Polymethyl methacrylate
<i>PVC</i>	Polyvinyl chloride
<i>RFU</i>	Relative fluorescence unit
<i>RNA</i>	Ribonucleic acid
<i>RND</i>	Resistance-nodulation-division
<i>ROS</i>	Reactive oxygen species
<i>rRNA</i>	Ribosomal RNA

## NOMENCLATURE

---

<i>RT</i>	Room temperature
<i>SARS</i>	Severe acute respiratory syndrome
<i>sp.</i>	Species
<i>spp.</i>	Species pluralis
<i>SPRI</i>	Solid phase reversible immobilisation
<i>SSI</i>	Surgical site infection
<i>TAE</i>	Tris-acetate-EDTA
<i>TE</i>	Tris-EDTA
<i>TSB</i>	Tryptic soy broth
<i>UHPNT</i>	University Hospitals Plymouth NHS Trust
<i>UK</i>	United Kingdom
<i>uPVC</i>	Unplasticised polyvinyl chloride
<i>USA</i>	United States of America
<i>UTI</i>	Urinary tract infection
<i>VAP</i>	Ventilator-associated pneumonia
<i>VBNC</i>	Viable but non-culturable
<i>VF</i>	Virulence factor
<i>VRE</i>	Vancomycin-resistant enterococci
<i>WGS</i>	Whole genome sequencing
<i>WHO</i>	World Health Organization
<i>WPS</i>	Wastewater plumbing system



# Chapter 1

## General introduction

*The following introduction provides background information relevant to the whole PhD project, and is built upon in individual chapters. Each chapter contains introductory and methods sections relevant to its themes and practical work.*

### **1.1 Antimicrobial resistance: background, solutions and approaches**

#### **1.1.1 Definitions and background**

The World Health Organization (WHO) defines antimicrobial resistance (AMR) as occurring "when bacteria, viruses, fungi and parasites change over time and no longer respond to medicines making infections harder to treat and increasing the risk of disease spread, severe illness and death" (World Health Organization, 2021). The term 'AMR' includes antibiotic resistance (ABR), but also extends to resistance to antivirals, antifungals, and antiparasitics.

The ability of bacteria to develop resistance to antibiotics was highlighted in the Nobel Prize acceptance speech of the microbiologist Sir Alexander Fleming, the discoverer of penicillin. Bacteria, particularly when found in high densities, are remarkably versatile microorganisms with the ability to develop tolerance and resistance to a wide range of conditions. These adaptations may occur through advantageous mutations, which are able to emerge and accumulate



### *1.1. ANTIMICROBIAL RESISTANCE: BACKGROUND, SOLUTIONS AND APPROACHES*

---

rapidly due to the haploid nature of the majority of bacterial genomes and relatively short generation times (Woodford and Ellington, 2007). Genes can also be shared between bacteria by means of horizontal gene transfer (HGT) (Soucy et al., 2015), either by conjugation via plasmids, transduction via bacteriophages, or transformation via extracellular DNA, allowing rapid spread of genes between strains and species including in clinical environments (Lerminiaux and Cameron, 2019).

While the fundamental evolutionary processes that drive the emergence of resistance are natural and the existence of antibiotic resistance predates human clinical use of antibiotics (Larsen et al., 2022), they are anthropogenically amplified; the scale of use of antimicrobial compounds has been described as "truly astonishing" (Roberts, 2020). Human clinical use and use in agriculture of antimicrobials with associated environmental release have created additional selective pressure, driving the emergence of resistance to an extent unlikely to otherwise have been reached (Manyi-Loh et al., 2018).

#### **1.1.2 Impact**

AMR has emerged as a serious threat to global public health, leading to potentially untreatable infections due to the unavailability of effective antimicrobials. The Review on Antimicrobial Resistance, commissioned in 2014 by the UK government, estimated that hundreds of thousands of deaths per year globally are attributable to AMR and that, by 2050, 10 million people could die annually of drug-resistant infections (O'Neill, 2016). However, there has been some debate over the reliability of these forecasts and a case made for the need to acknowledge that predictions always require assumptions (De Kraker et al., 2016). A comprehensive study of the global AMR burden in 2019 used counterfactuals

## 1.1. ANTIMICROBIAL RESISTANCE: BACKGROUND, SOLUTIONS AND APPROACHES

---

of 'no infection' and 'drug-sensitive infection' to model disease burden (Murray et al., 2022). The authors reported that an estimated 4.95 million deaths were associated with bacterial AMR (*i.e.* deaths that would not have occurred if there had been no infection), with 1.27 million deaths attributable to bacterial AMR (*i.e.* deaths that would not have occurred had the infection been drug-sensitive). One study found that the burden of antibiotic resistant infections is comparable to the cumulative burden of influenza, tuberculosis and HIV/AIDS, most seriously affecting children aged <1 year and the elderly aged >65 years. Furthermore, it was reported that 39% of all resistant infections are caused by bacteria with resistance to last-line or last-resort antibiotics, indicating that they are very difficult or even potentially impossible to treat with our current drug repertoire (Cassini et al., 2018). It has been estimated that the number of deaths in the USA caused by multidrug-resistant organisms could be 7-fold higher than that previously estimated by the Centers for Disease Control and Prevention, which would make multidrug-resistant infections the third most common cause of death in the USA in 2010 (Burnham et al., 2018).

### 1.1.3 Infection prevention and control as a solution

The Review on Antimicrobial Resistance recommended a list of nine interventions needed to reduce the severity of AMR (O'Neill, 2016). The first recommended intervention referred to a need for a global public health campaign, with the goal to build understanding of AMR and create the circumstances for behavioural change. The second recommendation cited the need to "Improve sanitation and prevent the spread of infection" in order to break the chain of transmission and thereby reduce the usage of antibiotics. Infection prevention and control (IPC) was stated as needing to be embedded as a priority in health-

care. Similarly, the study of the global burden of AMR in 2019, co-authored by a range of AMR collaborators, gave improved IPC as its first intervention and described it as a "cornerstone in combating the spread of AMR" (Murray et al., 2022). While novel drug discovery and development are critical to the future of antimicrobial chemotherapy, measures such as improving sanitation and reducing the incidence of infections will ultimately slow the development and spread of resistance and allow drugs to be reserved for those most in need.

#### **1.1.4 The 'One Health' approach to antimicrobial resistance**

It is increasingly being appreciated that the majority of emerging infectious diseases originate in animals, with a primary cause of their emergence being human-driven activities such as changes in ecosystems and land use, agriculture, urbanisation, and international travel and trade (Jones et al., 2008; Karesh et al., 2012; Jones et al., 2013). The term 'One Health' was first recorded around 2003–2004, in association with the emergence of severe acute respiratory syndrome (SARS) and the spread of avian influenza H5N1. It can be broadly described as a collaborative and multidisciplinary approach, combining animal, human, and environmental health - although there is no single, internationally agreed definition (Mackenzie and Jeggo, 2019). The One Health approach is particularly relevant to AMR as resistance can arise in any of the three domains (humans, animals, the environment), and can spread between them. A summary of the research areas and goals needed in the context of the One Health approach to AMR can be found in Table 1.1, and an illustration of the possible routes of spread of antibiotic resistant bacteria between people, animals and the environment is shown in Figure 1.1.

Several countries have implemented national action plans based on the One

## 1.1. ANTIMICROBIAL RESISTANCE: BACKGROUND, SOLUTIONS AND APPROACHES

---

Health concept, incorporating the strategies and goals listed in Table 1.1 (Aslam et al., 2021). The One Health approach has become dominant, being considered comprehensive and offering a global solution (Badau, 2021).

*Table 1.1: Summary of research areas and goals within the One Health approach to antimicrobial resistance.*

<b>Human</b>	<b>Animal</b>	<b>Environment</b>
Prevent infections	Limit mass medication of animals	Develop novel strategies to passively reduce environmental persistence and growth of resistant bacteria
Reduce antimicrobial over-prescribing	Limit antimicrobials in animal feed	Reduce pharmaceutical pollution
Improve sanitation and hygiene	Optimise antimicrobial prescribing	Improve surveillance
Improve infection control	Improve education and engagement in agriculture	Improve education and stakeholder engagement
Develop novel antimicrobials and vaccines	Reduce infection burden; develop novel vaccines	Improve appreciation of the environment as a niche for bacterial persistence and pathogen emergence
Develop rapid diagnostic tests for infection and resistance	Develop rapid diagnostic tests for infection and resistance	Improve wastewater management and minimise discharges to the natural environment

## 1.1. ANTIMICROBIAL RESISTANCE: BACKGROUND, SOLUTIONS AND APPROACHES

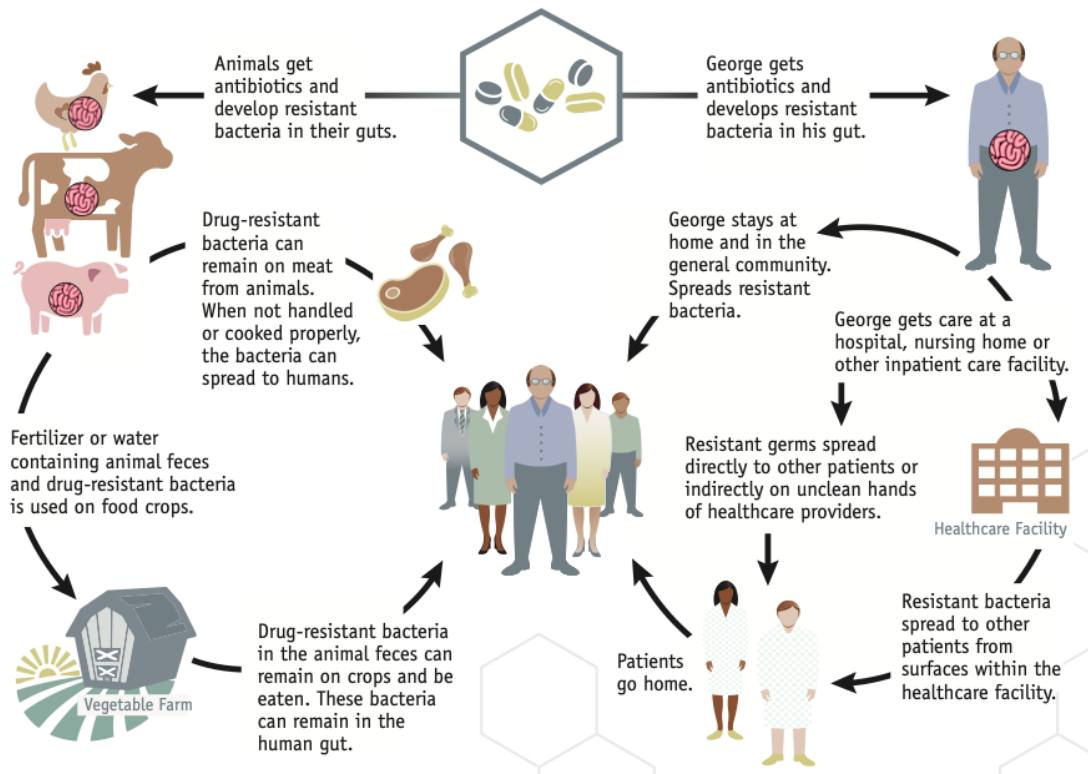

*Figure 1.1:* Illustration of the possible routes of spread of resistant bacteria. Bacterial resistance to antibiotics can arise in any of the three domains; humans, animals and the environment, and can spread between them. When antibiotics are prescribed to humans or animals, bacteria with resistance to that antibiotic may emerge. In animals, those bacteria have the potential to spread via uncooked or improperly handled meat, or via animal faeces being used on crops which are then eaten. In humans, following antibiotic usage, resistant bacteria can be spread directly to others in the community or in healthcare settings. Resistant bacteria may also be spread via environmental niches and vectors such as surfaces in healthcare facilities. Figure taken from CDC (2013).

## 1.2 Routes of acquisition of infection

In general terms, the routes of acquisition of infection can be summarised into the following categories (Madigan, 2017):

- Direct contact - via physical contact with the tissues or fluids of an infected individual.
- Fomite transmission - via physical contact with inanimate objects contaminated by an infected individual (e.g. environmental surfaces, medical equipment, clothing).
- Airborne transmission - via small particles and aerosols which may be produced by breathing, coughing, sneezing or speaking, which are then inhaled.
- Oral transmission - via ingestion of contaminated food or water.
- Vector-borne transmission - via living organisms (e.g. mosquitoes, fleas, ticks) which transfer pathogens from one site to others, including to susceptible hosts.
- Zoonotic transmission - via transmission of disease from animals to humans.

The route of acquisition taken depends on the specific microorganism, with certain organisms having well-defined and archetypal routes such as *Plasmodium falciparum* which infects the *Anopheles* mosquito. The bite of an infected female *Anopheles* mosquito is the first step of malaria infection in humans (Frevert, 2004). Other more contagious microorganisms may be transmitted by multiple routes, leading to increased contagion. One example is varicella-zoster

virus, causing chickenpox, which may be transmitted via direct contact with blisters, saliva or mucous of an infected person, through the air following coughing or sneezing, or via objects or materials known as fomites (Marin et al., 2021).

## 1.3 Nosocomial infections

### 1.3.1 Definitions

Several different terms are commonly employed in this field, often with overlapping or interchanging definitions. These include ‘hospital-acquired infections’ (HAIs), ‘healthcare-associated infections’ (HCAs), ‘nosocomial infections’, and ‘iatrogenic infections’ (Garner et al., 1988; Sydnor and Perl, 2011; Rosenthal et al., 2012; National Institute for Health and Care Excellence, 2016). In general, the first three terms refer to infections acquired in hospital or healthcare environments, either as a result of a medical intervention or as the result of passive exposure to hospital or healthcare settings. The latter term, ‘iatrogenic’, refers solely to infections acquired as the result of some form of medical intervention such as a surgical operation or examination. ‘Nosocomial infections’ are generally considered to be interchangeable with ‘hospital-acquired infections’, whereas ‘healthcare-associated infections’ is a broader term including types of care setting other than hospitals (*e.g.* general practice surgeries, hospices, nursing/care homes). The term ‘nosocomial infections’ is used in this thesis.

### 1.3.2 Significance and impact

Nosocomial infections cost both lives and money. In the USA, 1.7 million patients per year acquire nosocomial infections during the course of their hospital

### 1.3. NOSOCOMIAL INFECTIONS

---

stay, and around 1 in 17 of these (approximately 100,000 patients) die (Klebens et al., 2007). Nosocomial infections are recognised as the most common complication of hospital care and are among the top 10 causes of death in the USA (Haque et al., 2018). In the UK, the 2016/2017 reporting period saw 834 000 healthcare-acquired infections across all NHS hospitals in England and 28 500 patient deaths as a result (Guest et al., 2020). The cost of these potentially preventable infections has been calculated at between £1 billion (Mackley et al., 2018) and £2.7 billion (Guest et al., 2020).

Overall, epidemiological analyses published by Public Health England show that the incidence of hospital-onset infection cases tended to remain stable over the period 2011–2019, with the most common causative microorganisms being methicillin-resistant *Staphylococcus aureus* (MRSA), methicillin-sensitive *Staphylococcus aureus* (MSSA), *Clostridioides difficile*, and *Escherichia coli*. The most common presentations of nosocomial infections are respiratory infections, including pneumonia and lower respiratory tract infections (22.8%), urinary tract infections (17.2%), and surgical site infections (15.7%) (National Institute for Health and Care Excellence, 2014). The UK government developed a particular focus on Gram-negative bloodstream infections (GNBSIs) with an initial focus on *E. coli* and an ambition to halve the incidence of healthcare-associated GNBSIs by March 2021.

Hospitals are high-risk environments for the transmission of infections of all types, and the impact of drug-resistant infections can be especially pronounced due to infection of immunologically-compromised individuals, the elderly, and the young. In developed countries, 7–10 % of all hospital inpatients will develop some form of nosocomial infection; this figure rises to around 30 % of patients in intensive care units (ICUs). In developing countries, in low- and middle-income



### 1.3. NOSOCOMIAL INFECTIONS

---

settings, nosocomial infection incidence can be even higher due to fundamental deprivations such as lack of access to clean running water for handwashing, inconsistent surveillance, and lack of trained personnel and infection control programmes (World Health Organization, 2011; Bardossy et al., 2016).

In addition to the problems they bring in the healthcare environment itself, the role of nosocomial infections in the global transmission of pathogenic microorganisms should not be underestimated. A genetic analysis of over 1,700 *Klebsiella pneumoniae* patient isolates from 244 hospitals in 32 countries has demonstrated that carbapenemase-producing *K. pneumoniae* is transmitted predominantly via nosocomial routes (David et al., 2019). A longitudinal study conducted using genomic surveillance of MRSA in the UK found that healthcare settings provided a platform for low-level transmission, resulting not in large nosocomial outbreaks but a cumulative effect of numerous clinically unrecognised episodes (Coll et al., 2017). It is therefore suggested that healthcare settings are a subtle driver of the transmission of drug-resistant pathogens beyond the clear and well-recognised patient outbreaks, leading to incidence and persistence of drug-resistant infections both in healthcare settings and in the wider community. This study also reported indirect transmission, likely due to "environmental contamination or colonised healthcare workers".

Environmental surfaces were once thought to make a negligible contribution to the transmission of nosocomial pathogens (Rhame, 1998), however, more recent findings have disputed this. A number of organisms including *C. difficile*, MRSA, vancomycin-resistant enterococci (VRE), *Pseudomonas aeruginosa*, and *Acinetobacter baumannii* are able to be shed from colonised patients and healthcare workers, survive on surfaces for months, and resist cleaning and disinfection (Kramer et al., 2006; Otter et al., 2011; Dyer et al., 2019).

### 1.3. NOSOCOMIAL INFECTIONS

---

Most recently, the SARS-CoV-2 pandemic causing coronavirus disease 2019 (COVID-19) has created immense pressure on global healthcare systems, and despite being a viral pandemic is likely to have led to a significant uptick in global antibiotic prescribing. There have been reports of up to 95% of COVID-19 inpatients being prescribed antibiotics (Langford et al., 2020; Zhou et al., 2020), which tend to be broad spectrum (Chen et al., 2020), despite few reports of bacterial coinfection (Rawson et al., 2020). This scenario is likely to have an impact on AMR due to the increased direct exposure of bacteria to antibiotics as well as through their excretion into wastewater treatment facilities leading to their release into effluent-receiving rivers and coastal waters (Comber et al., 2020). In addition to antibiotics, the increased use of biocides and disinfectants is likely to have led to increased rates of resistance (Levy, 2002; Pal et al., 2015; Webber et al., 2015; Chen et al., 2021; Mahoney et al., 2021).

Within clinical settings, certain pathogen reservoirs provide niches for bacterial persistence (Dancer, 2011). These potential reservoirs may include: surfaces such as floors, furniture, shelves, tables, door handles, bed rails, bedding, computers and phones (Dancer, 1999; Lemmen et al., 2004; Weber et al., 2010; Menezes et al., 2022; Shobo et al., 2022), sinks, showers, baths, toilets, commodes (Noble et al., 1998; Lemmen et al., 2004; Alfa et al., 2008; Delaney, 2017), and buckets, bowls, mops and fluids (Westwood et al., 1971; Mackay et al., 2017; Shobo et al., 2022). Concerns regarding pathogen reservoirs in clinical settings are further raised by the evidence suggesting that patients admitted to spaces previously occupied by individuals suffering from infections (from *e.g.* MRSA, VRE, *C. difficile*, extended-spectrum  $\beta$ -lactamase-producing coliforms, *Acinetobacter* or *Pseudomonas*) are significantly more likely to acquire those infections (Huang et al., 2006; Mitchell et al., 2015).

### 1.3.3 Hospital wastewater plumbing systems

Wastewater plumbing systems (WPS) in hospitals are becoming increasingly appreciated as a potential niche for bacterial persistence, growth and transmission (Gormley et al., 2017; Volling et al., 2020). In the periphery of the WPS, *i.e.* the last 2 metres of pipework from an outlet and ensuing devices including drainage (Weinbren et al., 2021), sink traps (also known as U-bends or P-traps) are a common feature and are designed to intentionally trap water in order to create a seal, preventing unwanted flow of sewer gases into the room (Figure 1.2).

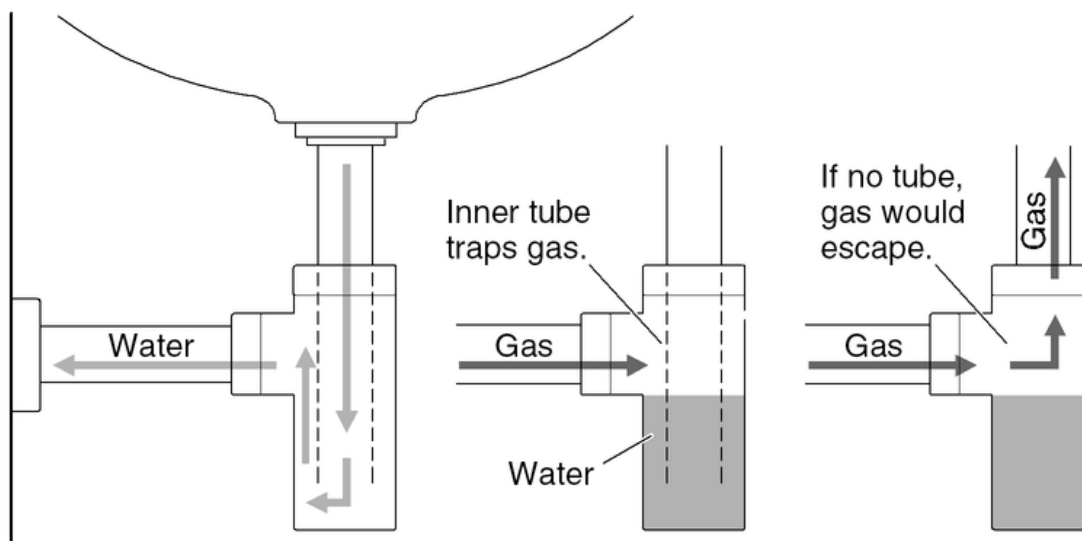

*Figure 1.2:* Diagram of a bottle-style sink trap. The inner tube (dotted lines) terminates lower than the effluent tube, meaning that wastewater flowing through the drain (light grey arrows) is trapped and a water seal is formed. The seal prevents gases (dark grey arrows) from the wastewater plumbing system and sewer from flowing into the sink and surrounding environment. Image taken from <http://kohler.co.uk>.

### *1.3. NOSOCOMIAL INFECTIONS*

---

Sink traps provide amenable growth conditions for bacteria (Dancer, 2014; Fusch et al., 2015; Soothill, 2016; Stjärne Aspelund et al., 2016). They are constantly re-seeded by hand washing and other activities leading to surface accumulation of significant bacterial numbers; hand washing reportedly represents only 4% of realistic hospital sink use, with 56 other sink-related activities identified introducing microbes and nutrients vital to their growth (Grabowski et al., 2018).

It has been anecdotally reported that as sluice sinks for the disposal of waste fluids are often located at the far end of hospital wards, hospital staff may assess the risk of carrying fluids the length of the ward and risking a spillage to be too high (Walker and Moore, 2015). Waste fluids may therefore be disposed of via handwashing sinks near patient beds, leading to heightened risk of microbial contamination. Awareness of this problem is increasing, with measures being put in place to educate users and discourage disposal of other fluids in sinks. Figure 1.3 shows a picture taken at Derriford Hospital (University Hospitals Plymouth NHS Trust) in December 2021 of a sink on a high-dependency ward, with a sign indicating that the sink should be reserved for handwashing only. Sinks are present in virtually all hospital wards and patient rooms to encourage hand hygiene best practice (Rashid, 2006; Hopman et al., 2017), creating a large number of potential bacterial reservoirs in proximity to patients and healthcare workers.

### 1.3. NOSOCOMIAL INFECTIONS

---



*Figure 1.3:* Sink on a high-dependency ward of Derriford Hospital (University Hospitals Plymouth NHS Trust) showing a sign indicating that the sink should be used for handwashing only, suggesting increased awareness that the use of ward sinks for disposal of fluids other than in handwashing is problematic. Picture taken in December 2021.

### 1.3. NOSOCOMIAL INFECTIONS

---

Research has established sinks and hospital plumbing as sources of outbreaks and reservoirs of pathogenic bacteria. Following the deaths of four neonates from *P. aeruginosa* infection in a Northern Irish hospital in December 2011 and early 2012, one group dismantled taps from the neonatal unit for analysis (Walker et al., 2014). *P. aeruginosa* biofilms were found in a number of tap components and some tap isolates had variable number tandem repeat profiles consistent with strains from the infected neonates, providing strong evidence of association between tap colonisation and patient infection.

Despite this evidence, an argument could be made that abiotic surfaces in contact with colonised patients are likely to become colonised themselves, but this does not prove a causal link or evidence of directionality between colonisation of WPS and infection of patients. In one study, the installation of disinfection devices to the traps of ICU sinks reduced colonisation by multidrug-resistant *P. aeruginosa* and resulted in a significant reduction in patient colonisation, linking sink colonisation with patient colonisation and suggesting transmission of *P. aeruginosa* from colonised sinks to patients (De Jonge et al., 2019).

To further solidify this link, another study used green fluorescent protein (GFP)-expressing *E. coli* to track bacterial dissemination in a simulated sink environment and showed that if bacteria were allowed to mature in the sink traps in conditions similar to those found in hospitals, a biofilm formed and extended upwards over 7 days (Kotay et al., 2017). This resulted in bacterial dispersion to the vicinity outside the sink during tap operation. Colonisation was also able to occur by retrograde (*i.e.* against flow) growth from a common pipe, enabling the spread of biofilm between different sinks. A follow-up study later sought to amend the accepted theory of the predominance of aerosol transmission from sinks, finding that the dispersal of microorganisms occurs primarily by droplet

### 1.3. NOSOCOMIAL INFECTIONS

---

dispersion rather than by aerosolisation (Kotay et al., 2018), though a combination of the two is likely.

An investigation of bacterial dissemination in a newly opened hospital using whole genome sequencing indicated frequent colonisation by *P. aeruginosa* of water and the environment in burns and critical care units (Quick et al., 2014). *P. aeruginosa* was identified in 50 % of water samples and 50 % of patient samples, with 141 genomes sequenced from water, the environment and patients. The number of distinct mutations between isolates was used to infer potential transmission events between water, the environment, and patients. The analysis indicated clustering of *P. aeruginosa* isolates by room and water outlet, with isolates from three patients having identical genotypes to water isolates from the same hospital room. This study indicated that even in a newly opened hospital, *P. aeruginosa* rapidly becomes endemic in the WPS, and provided evidence that transmission events occurred between the WPS and patients. Whole genome shotgun sequencing of a biofilm from a thermostatic mixer valve identified *P. aeruginosa* of the same clade as isolates identified from shower and tap environments elsewhere as the most abundant taxon, suggesting the likely common source of *P. aeruginosa*. A later study involving four large UK hospitals performed similar investigations with all water outlets in augmented care units being sampled over a 16-week period (Halstead et al., 2021). The investigation found 51 water outlets persistently positive for *P. aeruginosa* and whole genome sequencing once again identified likely transmission from outlets to patients in 3/4 of the hospitals studied. Overall, the authors were able to conclude that 5 % of patients studied 'definitely' acquired their *P. aeruginosa* from their water outlets. Together, these studies present compelling evidence - utilising whole genome sequencing to track and distinguish isolates - of widespread

### 1.3. NOSOCOMIAL INFECTIONS

---

bacterial colonisation of WPS and directionality of transmission from water outlets to patients in critical care environments of hospitals.

Following a period of 66 patient cases of  $\beta$ -lactamase-producing *Klebsiella oxytoca* in a Canadian hospital between 2006–2011, new cases continued to occur despite reinforcement of infection control measures and contact precautions for colonised patients (Lowe et al., 2012). The introduction of: sink cleaning three times per day, modifications to sink drains, and an antimicrobial stewardship programme, led to a reduction of new infections to zero. The results demonstrate that hospital sinks act as microbial reservoirs, providing an avenue for pathogens to be reintroduced into the environment and preventing the control of new infections. Similarly, in the ICU of a hospital in the Netherlands between 2010–2012, patients were colonised with extended-spectrum  $\beta$ -lactamase-producing bacteria (ESBLs), one resulting in fatal infection, shown to produce identical amplified fragment length polymorphism fingerprints to ESBLs isolated from sinks. Transmission from sinks to patients was stopped by the installation of self-disinfecting sink traps to all sinks in the unit. These sink traps prevent the formation of a biofilm by utilising heat, ultrasound, electromagnetic cleansing and an antibacterial coating (Wolf et al., 2014). While the authors described this intervention as 'cost-effective', the total cost was 34 000€ for installation to 18 sink traps, equating to 1888€ per sink trap.

The WPS has been shown to act as a distribution network for microorganisms, a phenomenon most notably identified during the 2003 SARS outbreak in Hong Kong when a 50-storey building had 321 confirmed cases and 42 deaths with defects in the WPS highlighted as allowing "virus laden droplets" to be transmitted through empty sink traps in bathrooms (World Health Organization, 2003; Hung et al., 2006). This was experimentally investigated using a full-scale two-



storey WPS test rig flushed with *Pseudomonas putida*, showing that viable microorganisms were carried on the system airflow between different floors of a building resulting in contamination of surfaces within both the system and rooms (Gormley et al., 2017). These routes of transmission and contamination effectively allow colonisation of sink traps to occur on the effluent side, independent of whether the immediate human environment is subject to stringent cleaning measures.

## 1.4 Surface colonisation: The role of biofilm

### 1.4.1 Definition and composition

Despite the vastness of the microbial world, it is increasingly becoming clear that biofilms are the predominant means by which microbial cells can thrive in a given environment (Costerton et al., 1978; Flemming et al., 2016). A biofilm can be described as an aggregation of microorganisms in a heterogeneous, sessile community, embedded in a dynamic matrix of extracellular polymeric substances (EPS) (Hoiby et al., 2010). The EPS itself is composed of a complex assembly of protein, polysaccharide and extracellular DNA, resulting in a three-dimensional architecture (Donlan, 2002; Singh et al., 2017). With the EPS matrix, known to account for up to 90% of the dry biofilm weight, it is perhaps most accurate to visualise a biofilm as a whole as a predominantly abiotic aggregate within which bacteria develop a niche (Flemming and Wingender, 2010).

### 1.4.2 Formation and development

Biofilms may form on biotic or abiotic surfaces and can be extremely robust and resilient once formed (Lejeune, 2003). Initial biofilm formation begins with the establishment of a so-called "conditioning film", a mixture of organic molecules which builds up on a nude surface in a fluid system. 'Floating' biofilms, for example those which form at air-liquid interfaces, do not require this substrate (Desai and Ardekani, 2020). A conditioning film then forms the basis of the attachment platform that bacterial cells use to establish adherence to the underlying substrate (Bhagwat et al., 2021; Rummel et al., 2021). Initial adhesion is largely dependent on cell appendages such as flagella, pili and fimbriae; these appendages are needed to overcome repulsive forces and anchor the cell to the substrate (Lejeune, 2003). Attachment of bacteria at this stage is reversible; cells may detach and rejoin the planktonic (free-floating) population if hydrodynamic or repulsive forces dictate, or in response to nutrient availability. In the case of the model biofilm-former *P. aeruginosa*, both flagellar and twitching motility are necessary for biofilm development (O'Toole and Kolter, 1998). *P. aeruginosa* can divide asymmetrically upon contact with a substrate to form a short-range twitching phenotype for exploration of the surface and a long-range flagellar phenotype able to explore further and seed new surfaces (Laventie et al., 2019).

Surface contact initiates a cascade of gene expression and regulation changes. Factors associated with a sessile state, such as the promotion of extracellular matrix production, are upregulated. This stage is often referred to as the 'motile-sessile switch' and is generally associated with a reduction in virulence and a move towards longer-term persistence (Sadiq et al., 2017). A major regulation mechanism at this stage is quorum sensing (QS) (a term coined by

## 1.4. SURFACE COLONISATION: THE ROLE OF BIOFILM

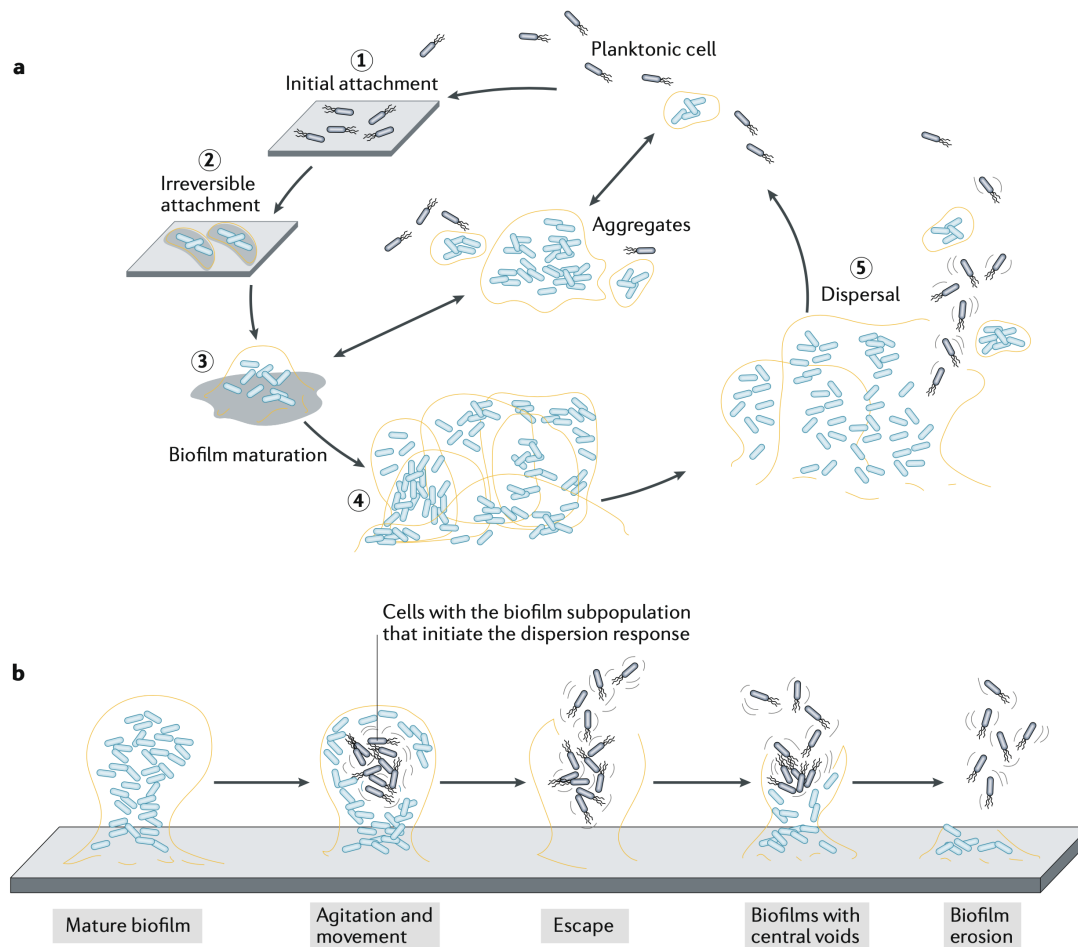

**Figure 1.4:** Schematic of (a) bacterial attachment, biofilm maturation and dispersal, and (b) the events that lead to biofilm dispersal. Upon encountering a substrate, bacteria form an initial reversible attachment at the cell pole or via flagellum (1). Attachment then becomes irreversible and cells form clusters which begin to produce matrix components (2). The biofilm matures as cell clusters become several layers thick and embedded in the matrix (3), leading to full maturation at maximum thickness (4). Dispersal is the final stage of the biofilm life cycle (5). Biofilm-like aggregates (middle of cycle schematic) can attach to surfaces and mature. In (b), biofilm dispersal events are shown, commencing with a subpopulation of cells exhibiting agitation and movement, and the biofilm becoming more fluid. Planktonic cells escape from microcolonies with the potential to seed new surfaces, leaving voids within biofilms which may lead to their total erosion. Figure taken from Rumbaugh and Sauer (2020).

#### *1.4. SURFACE COLONISATION: THE ROLE OF BIOFILM*

---

Fuqua et al. (1994)), a method of intercellular communication in bacteria enabling coordination of behaviour based on population density, achieved by the secretion and detection of signalling molecules termed autoinducers. Autoinducers are usually constitutively expressed by individual bacteria; at low cell density, these signals are lost to diffusion (Schuster et al., 2013; Papenfort and Bassler, 2016). As cell density grows, the local concentration of autoinducers follows and once a threshold level is reached, changes in gene expression are triggered. By synthesising, secreting and detecting autoinducers, bacteria are able to coordinate their development into a community and diversify their individual activities, allowing the development of a complex biofilm community with a greater chance of long-term persistence (Tuon et al., 2022). Biofilm-forming bacteria also actively disperse cells from the biofilm, leading to release of bacteria to seed new niches. Examples of mechanisms through which active biofilm dispersal can proceed include enzymatic degradation of the EPS matrix or of the biofilm substrate, seeding dispersal where planktonic cells are released from biofilm cavities, the production of rhamnolipids, or through modulation of fimbrial adherence (Kaplan, 2010; Rumbaugh and Sauer, 2020).

The long-term endurance of a biofilm is in part assured by the emergence of persister cells; a small subset of the wider population with reduced metabolism via the downregulation of gene expression related to protein, ribosome and cell wall biosynthesis and virulence factors (Kim, 2001; Keren et al., 2004). While this results in persister cells having arrested cell growth and division, it also favours their survival in the case of assault by antimicrobials or biocides. In the case of large-scale biofilm destruction, persister cells can switch back to normal growth patterns upon removal of the stress and repopulate the biofilm. As well as more specialised persister cells, all cells in a biofilm undergo some

metabolic changes compared to their planktonic counterparts (Crabbé et al., 2019; Pisithkul et al., 2019).

##### 1.4.3 Clinical relevance

Clinically, biofilms pose a significant problem as they enable bacteria to become 10–1000 fold more resistant to antimicrobials, adhere to surfaces and resist mechanical disruption, and diversify their phenotypes to facilitate long-term persistence (Hengzhuang et al., 2012; Marquès et al., 2015). According to the US National Institutes of Health, biofilms are involved in over 80% of microbial infections (Davies, 2003). The emergence of persister cells within a mature biofilm is of particular relevance to infection control as it allows biofilms to recover following exposure to disinfectants or biocides, eventually leading to repopulation of the biofilm with viable bacteria. The hardy nature of the EPS matrix makes biofilms extremely refractory to attack, *e.g.* during routine disinfection of surfaces in healthcare settings. Much of this effect is due to passive factors, such as the reduction of diffusion caused by the thick and complex nature of the EPS resulting in reduced proportions of antimicrobials reaching bacterial cells and not penetrating the whole thickness of the biofilm (De Beer et al., 1994; Jang et al., 2006; Bridier et al., 2011).

Biofilms may form on a range of medical devices including catheters, implants, ventilator tubing and environmental surfaces in healthcare settings in proximity to infirm or immunocompromised patients. Where biofilms form, particularly if they develop on hard to reach surfaces that are not routinely disinfected or changed, they represent a local reservoir of pathogenic bacteria and therefore a potentially major threat to patient outcomes. A number of studies have established biofilms on the interior surfaces of hospital WPS to be the origin

of nosocomial infections, providing evidence that biofilms act as pathogenic reservoirs resulting in patient morbidity and mortality (Lowe et al., 2012; Walker et al., 2014; Wolf et al., 2014; Kotay et al., 2017, 2018).

## 1.5 Nanomaterials

### 1.5.1 Definitions and background

Nanomaterials can be defined as materials with particles or constituents with a dimension of between 1–100 nm (Masciangioli and Zhang, 2003; Besinis et al., 2015). See Figure 1.5 for an illustration of the relative size of nanomaterials. The behaviour of nanomaterials can often be unique and distinct from that of their bulk counterparts because their properties are not exclusively determined by their mass or chemical composition, as with most macro-scale materials.

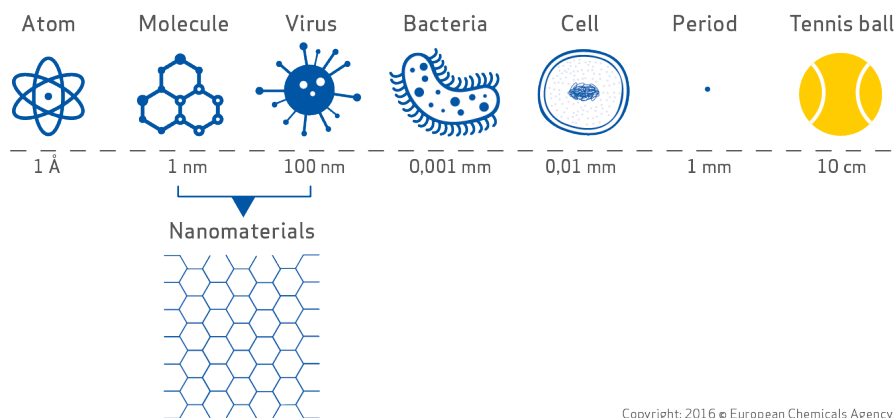

Copyright: 2016 © European Chemicals Agency

*Figure 1.5:* Relative size of nanomaterials, generally considered to be within the size range of 1–100 nm. Image taken from <https://euon.echa.europa.eu>.

The properties of nanomaterials and the biological interactions they are involved in are affected by factors such as particle size (Oberdörster et al., 2000; Besinis, van Noort and Martin, 2014), shape, surface area to volume ratio

(Navya and Daima, 2016; Yin et al., 2020), crystallinity (Sayes et al., 2006), and surface charge (Besinis et al., 2012). Through rational design and tuning of size, shape, synthesis conditions, and functionalisation, nanomaterials can be developed for specific functions (Baig et al., 2021).

### 1.5.2 Nanomaterials as antimicrobials

The most widely investigated antimicrobial nanomaterials come in the form of metal and metal oxide nanoparticles (silver, zinc oxide, titanium dioxide, copper oxide and gold) (Allaker, 2010), non-metallic nanomaterials (silica nanoparticles and chitosan) (Jayakumar et al., 2010; Xu et al., 2017), or carbon-based nanomaterials composed of allotropes of carbon such as graphene, arranged in different three-dimensional shapes such as sheets, carbon nanotubes and fullerenes (Szunerits and Boukherroub, 2016; Henriques et al., 2018).

A number of different metals, chiefly silver (Ag), have been used in medicine since ancient times due to their inherent antimicrobial properties (Klasen, 2000). Bulk or colloidal silver has been suggested to be the most important antimicrobial available prior to the introduction of antibiotics (Alexander, 2009). The growing use of nanomaterials could be thought of as a continuation of this theme; the antimicrobial properties can be amplified by the use of nanosilver such as silver nanoparticles (Sim et al., 2018; Ullah Khan et al., 2018).

In general, the antibacterial mechanism of action of nanomaterials (see Figure 1.6) involves the generation of cations which can react with sulphhydryl groups in bacterial enzymes, disrupting functions such as transmembrane energy generation and electrolyte transport (Klueh et al., 2000). Metal cations (*e.g.* Ag<sup>+</sup>) can uncouple the respiratory electron transport chain from oxidative phospho-

## 1.5. NANOMATERIALS

rylation, and interfere with penetration of  $H^+$  and phosphate into membranes (Schreurs and Rosenberg, 1982; Dibrov et al., 2002; Holt and Bard, 2005).

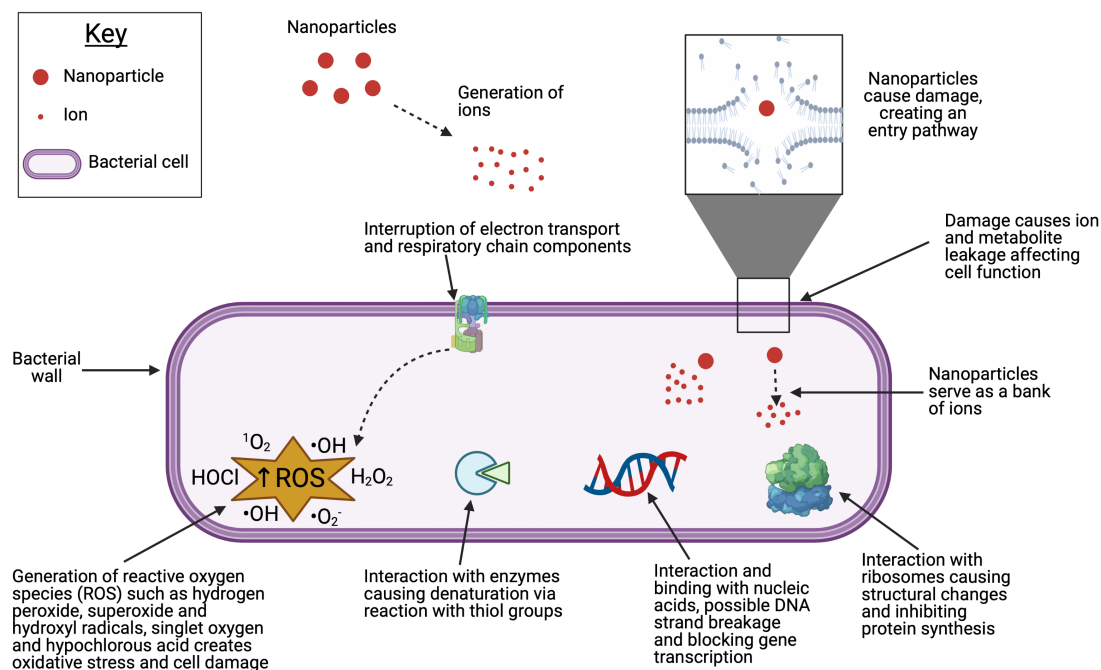

**Figure 1.6:** Antibacterial mechanisms of nanoparticles. Nanoparticles gain entry to the bacterial cell through cell wall damage, which itself leads to leakage of ions and metabolites, conferring an antibacterial effect. Inside the cell, nanoparticles act as a reservoir of ions which interact with ribosomes, nucleic acids, and enzymes, conferring antibacterial activity by disrupting their normal function. Interruption of the respiratory chain leads to generation of reactive oxygen species, leading to intracellular oxidative stress and damage to bacterial cell components. Figure created using [biorender.com](https://www.biorender.com).

Metal cations can form complexes with nuclear material by intercalation between base pairs, disrupting hydrogen bonds and ultimately preventing effective cell division (Arakawa et al., 2001; Barras et al., 2018). Nanomaterials are also associated with the generation of reactive oxygen species (ROS) within bacteria, either by disruption of the thioredoxin system (Liao et al., 2017), or by interaction with the respiratory chain and interruption of intracellular  $O_2$  reduction (Long et al., 2017). Due to their size, nanomaterials pose a threat to the



bacterial cell wall, with both anchorage and infiltration possible, ultimately leading to damage, leakage of cellular contents and influx of fluid, and cell death (Xie et al., 2011; Lemire et al., 2013; Seong and Lee, 2017; Wang et al., 2018).

### 1.5.3 Antimicrobial silver nanocoatings

While free or colloidal nanoparticles can be effective antimicrobials, this project proposes that their application, in an immobilised form as a coating, has the potential to effectively apply their antibiofilm properties while minimising material loss and prolonging the lifespan of their activity. As described in Section 1.4, the relatively high resistance of biofilms to antimicrobials means that the ideal scenario would be early prevention of initial biofilm formation and this requires interruption of bacterial adherence to materials or early toxicity to bacterial cells. In the case of environmental surfaces, especially those in hard-to-reach places such as plumbing systems, antimicrobial nanocoatings could be developed to passively operate, without requiring regular human input.

Silver nanoparticles can be applied as a nanocoating on dentine which is stable in biological fluids, prevents biofilm formation, and inhibits bacterial growth in the surrounding media (Besinis, De Peralta and Handy, 2014a). Silver nanoparticles in this form were found to be more bactericidal towards the oral pathogen *Streptococcus mutans* than the oral disinfectant chlorhexidine, and while silver nanoparticles were equally as bactericidal as silver nitrate they did not cause dentinal discolouration. Similar nanocoatings were later studied following application to titanium alloy medical implants; silver-plated titanium discs exhibited the highest antibacterial activity and strong antibiofilm activity with a low rate of silver dissolution from the material (Besinis et al., 2017). Similar nanocoatings on silicone maxillofacial prostheses *in vitro* additionally showed strong evi-

dence of biocompatibility, with morphology of dermal fibroblasts grown exposed to silver nanoparticles not differing from that of fibroblasts grown without silver nanoparticle exposure and prevention of relevant fungal (*Candida albicans*) growth also demonstrated (Meran et al., 2018). A silver nanocoating on polymethyl methacrylate (PMMA), a material commonly used in medical implants, has been described (Petrochenko et al., 2017). Silver nanoparticles and PMMA were simultaneously ablated using pulsed laser deposition, forming a uniform porous thin film on silicon wafers. The pulsed laser deposition process could be varied to optimise the thickness of the nanocoating, in order to maximise the protection against *E. coli* colonisation whilst minimising toxicity to nearby host tissues. A nanocoating consisting of silver nanoparticles immobilised on a functionalised silica surface has also been described (Agnihotri et al., 2013), conferring potent bactericidal activity against both *E. coli* and *Bacillus subtilis*, leading to complete disinfection within 2 hours.

Overall, silver nanoparticles have a strong background in application to surfaces as an antimicrobial nanocoating and therefore show promise in future research to develop novel nanocoatings for other relevant surfaces.

### 1.6 Bacterial resistance to silver nanoparticles

Some publications claim that a benefit of antimicrobial nanomaterials is the low probability of bacteria developing resistance to their effects. This is due to the range of bacterial targets and mechanisms of action generally differing from those of conventional antibiotics (Rai et al., 2009; Gunawan et al., 2017). However, microbiological research has found that the development of metal resistance is likely to be unavoidable. For antimicrobial agents such as nanopar-

## *1.6. BACTERIAL RESISTANCE TO SILVER NANOPARTICLES*

---

ticles, the emergence of resistance is likely to occur through reduction of ions (Muller, 2018), sequestration or aggregation of nanoparticles (Panacek et al., 2018), or their efflux (Delmar et al., 2013; Randall et al., 2015). A particular concern, in the wider context of AMR, is the possibility of the use of non-antibiotic antimicrobial compounds such as nanomaterials leading to promotion of resistance against antibiotics through various mechanisms (Zhang et al., 2020). One such mechanism is the promotion of horizontal gene transfer; both silver nanoparticles and silver cations ( $\text{Ag}^+$ ) have been shown to increase conjugative transfer frequency by inducing ROS overproduction and increasing membrane permeability at environmentally- and clinically-relevant concentrations (Lu et al., 2020). The authors identify a ROS scavenger as a potential means to reduce silver-induced conjugative transfer of antibiotic resistance genes. It may also be important to consider some means of cleaning or maintenance to prevent the emergence and accumulation of resistant clones on antimicrobial nanocoatings over time. The genetic basis of bacterial resistance to nanoparticles is summarised in Figure 1.7.

Silver nanoparticles have become increasingly present in our society; the need for monitoring of the emergence of resistance following silver's renewed popularity was raised by Chopra (2007) and echoed by Bayston et al. (2007). A wide-ranging set of estimates have been made regarding the total worldwide silver nanoparticle production. Some of these estimates include 210 tonnes per year (Pulit-Prociak and Banach, 2016), 320 tonnes per year (Gottschalk et al., 2009) and 500 tonnes per year (Mueller and Nowack, 2008), with an expectation that it will rise to approximately 800 tonnes per year by 2025 (Pulit-Prociak and Banach, 2016). Silver nanoparticles have become common in a range of consumer products, leading to increased human exposure to them,

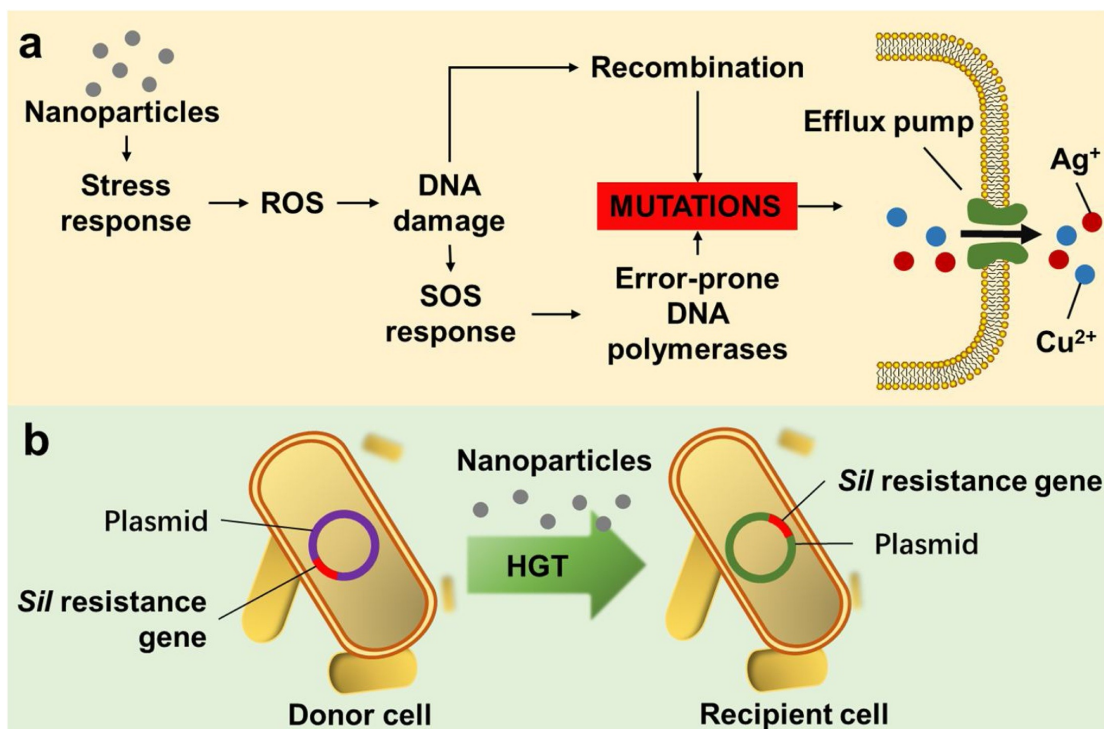

*Figure 1.7:* Summary of the genetic basis of bacterial resistance to nanoparticles. In (a), reactive oxygen species (ROS)-mediated DNA damage leads to mutations conferring efflux pump activity against nanoparticles. In (b), horizontal gene transfer (HGT) of a silver resistance gene (*Sil*) on a plasmid via conjugation leads to spread of silver resistance between bacteria. Figure taken from Zhang et al. (2020).

with presumably greater exposure to bacteria following (Tulve et al., 2015; Potter et al., 2019). With the context of the AMR crisis meaning that alternative antimicrobials, including nanomaterials, become more important in our arsenal, important decisions need to be made by policymakers regarding stewardship of antimicrobial nanomaterials - in the same way that antibiotic stewardship has entered the mainstream.

These concerns regarding resistance should not detract from the opportunities that nanomaterials bring in terms of antimicrobial development, as the emergence of bacterial resistance should be considered an eventual certainty for any novel antimicrobial in development. It is important however to include these

considerations in the antimicrobial development process in order to limit any unwanted side effects such as the promotion of AMR, and conserve resources through the application of antimicrobial stewardship programmes and improved education.

## 1.7 Hypothesis

The hypothesis was that a silver nanocoating could be developed for application to pipe polymer surfaces to reduce the extent of bacterial colonisation and growth. Such surfaces would, therefore, reduce the dissemination of potential pathogens to patients if deployed in clinical settings.

## 1.8 Aims

In general, this PhD project aimed to build on the work completed previously by Besinis et al. (2014*a*; 2014*b*; 2017) and Meran et al. (2018) which applied nanomaterials such as silver nanoparticles to various substrates, embedded within a matrix, to achieve antiplanktonic and antibiofilm effects (described in more detail in Section 1.5.3). Specifically, this project aimed to develop an antimicrobial silver nanocoating for application to surfaces in WPS.

## 1.9 Objectives

To achieve the above aims, the following objectives were set:

- Characterise the bacteria present in sink traps using both culture-dependent and -independent techniques.

- Develop a silver nanocoating for application to pipe polymer surfaces.
- Characterise the material properties of the test substrate and nanocoatings using different analytical techniques.
- Test the antibacterial properties of the developed silver nanocoating in an *in vitro* setting against a panel of relevant bacterial strains.
- Conduct *in situ* testing of the developed nanocoating by installing nanocoated material in a real-world wastewater plumbing system and evaluating its long-term antibacterial efficacy.

## 1.10 Significance

The previous studies gave this project a firm grounding in the published literature, though the literature available on the application of nanoparticles as an antimicrobial coating is limited compared to the range of publications available on nanoparticles presented in solution. This indicates that the development of antimicrobial nanocoatings is a more specialised area, with extensive potential for development. In particular, this project offered a new approach by developing a silver nanocoating for application to plumbing polymer surfaces in healthcare settings. To date, there have been no published reports of any attempt to do this, highlighting a high level of originality. Investigating this new application expands the scope of nanosilver use and contributes to knowledge regarding the application of antimicrobial nanocoatings to polyvinyl chloride, an extremely relevant and commonly used polymer in domestic and healthcare settings throughout the world. To further demonstrate its relevance, the project also addressed the second intervention recommended by the UK government-commissioned O'Neill review on tackling drug-resistant infections; intervention

### *1.10. SIGNIFICANCE*

---

2 of 9 is entitled "Improve sanitation and prevent the spread of infection" and refers to breaking the chain of transmission of infections to reduce the use of antibiotics and limit the impact of drug-resistant infections (O'Neill, 2016).

## Chapter 2

# Investigation of hospital sink traps

The content within this chapter contributed to the following publication:

**Butler, J.**, Kelly, S. D., Muddiman, K. J., Besinis, A. & Upton, M. (2022). Hospital sink traps as a potential source of the emerging multidrug-resistant pathogen *Cupriavidus pauculus*: characterization and draft genome sequence of strain MF1. *Journal of Medical Microbiology*, 71(2), 10.1099/jmm.0.001501.

### 2.1 Introduction

As described in Chapter 1, sink traps are a niche for bacteria to persist and avoid disinfection through biofilm formation. A study reported that hospital sink traps contain  $10^6$ – $10^{10}$  colony-forming units per millilitre (CFU mL<sup>-1</sup>) of predominantly Gram-negative rods (Döring et al., 1991), indicating a dense community of microorganisms with the potential to share genes by horizontal gene transfer and be dispersed through the production of aerosols and droplets. A variety of bacteria have previously been isolated from hospital sinks; see summary in Table 2.1. The inaccessibility of sink traps, as well as their wet and relatively stable conditions, contribute to their ability to support a diverse bacterial community (Dancer, 2014). This inaccessibility likely leads to sink traps being overlooked in routine cleaning, further compounding the problem.



## 2.1. INTRODUCTION

---

Table 2.1: Summary of bacteria previously isolated from hospital wastewater plumbing systems using culture-based methods

<b>Bacteria isolated</b>	<b>Reference</b>
<i>Klebsiella pneumoniae</i>	Nakamura et al. (2021)
<i>Enterobacter cloacae</i>	Nurjadi et al. (2021)
<i>Stenotrophomonas maltophilia</i> <i>Pseudomonas aeruginosa</i> <i>Achromobacter</i> spp. <i>Acinetobacter</i> spp. <i>Enterobacter</i> spp. <i>Citrobacter</i> spp. <i>Klebsiella</i> spp.	Franco et al. (2020)
<i>Citrobacter freundii</i> <i>Enterobacter hormaechei</i> <i>Serratia marcescens</i> <i>Klebsiella quasipneumoniae</i>	Kotay et al. (2020)
<i>Klebsiella pneumoniae</i> <i>Citrobacter freundii</i> <i>Phytobacter ursingii</i> <i>Serratia marcescens</i>	Park et al. (2020)
<i>Pseudomonas aeruginosa</i>	De Jonge et al. (2019)
<i>Escherichia coli</i> <i>Enterobacter cloacae</i>	Decraene et al. (2018)
<i>Serratia marcescens</i>	Regev-Yochay et al. (2018)
<i>Citrobacter freundii</i> <i>Klebsiella oxytoca</i> <i>Klebsiella pneumoniae</i> <i>Escherichia coli</i>	De Geyter et al. (2017)
<i>Pseudomonas aeruginosa</i>	Zhou et al. (2016)
<i>Klebsiella oxytoca</i>	Leitner et al. (2015)
<i>Klebsiella pneumoniae</i>	Seara et al. (2015)
<i>Citrobacter freundii</i> <i>Enterobacter cloacae</i> <i>Escherichia coli</i> <i>Klebsiella oxytoca</i> <i>Klebsiella pneumoniae</i> <i>Serratia marcescens</i>	Wolf et al. (2014)
<i>Acinetobacter baumannii</i>	La Forgia et al. (2010)
<i>Pseudomonas aeruginosa</i>	Orrett (2000)
<i>Pseudomonas aeruginosa</i>	Ayliffe et al. (1974)

## 2.1. INTRODUCTION

---

The studies summarised in Table 2.1 utilised culture-based methods to detect and identify bacteria from hospital WPS. These studies suggest that the sink trap flora is dominated by the family *Enterobacteriaceae*, including organisms such as *Klebsiella pneumoniae*, *Citrobacter freundii*, *Enterobacter* spp., and *Escherichia coli*. The summary in Table 2.1 supports the findings of Döring et al. (1991) regarding the dominance of Gram-negative bacteria, with no isolations of Gram positive bacteria being reported. Ledwoch et al. (2020) also reported dominance of Gram-negative bacteria when sampling sink trap bacteria from a common room sink trap at Cardiff University. A number of the organisms listed in Table 2.1 have been implicated in nosocomial disease and outbreaks leading to patient colonisation or morbidity and mortality with links to the WPS, including *P. aeruginosa* (Hota et al., 2009; Knoester et al., 2014; Walker et al., 2014; De Jonge et al., 2019), *K. pneumoniae* (Starlander and Melhus, 2012; Kotsanas et al., 2013; Roux et al., 2013), *K. oxytoca* (Lowe et al., 2012; Roux et al., 2013), *Citrobacter freundii* (Roux et al., 2013), *A. baumannii* (Hong et al., 2012), *Serratia marcescens* (Kotsanas et al., 2013), *Enterobacter cloacae* (Kotsanas et al., 2013; Roux et al., 2013), and *Escherichia coli* (Kotsanas et al., 2013).

An organism not frequently reported but observed during the current study is *Cupriavidus pauculus*. A member of the family *Burkholderiaceae*, *C. pauculus* is a Gram-negative, peritrichously flagellated bacillus originally known as 'CDC Group IVc-2' before reclassification as a species of *Ralstonia* (Moissenet et al., 1999), then of *Wautersia* (Vaneechoutte et al., 2004), before its final transfer to the genus *Cupriavidus* (Vandamme and Coenye, 2004). Historically described in soil and environmental water samples (Watanabe et al., 2015; Feng et al., 2019), *C. pauculus* has been reported to be emerging as a cause of human

## 2.1. INTRODUCTION

---

infection and mortality. *C. pauculus* has been described as an opportunistic pathogen of interest (Langevin et al., 2011), with case reports of infection in immunocompromised (Almasy et al., 2016; Bianco et al., 2018) and immunocompetent (Duggal et al., 2013; Yahya et al., 2017) people, and those with cystic fibrosis (Kalka-Moll et al., 2009; LiPuma, 2010), with evidence of nosocomial transmission (Stovall et al., 2010; Huda et al., 2020). Some reports have linked *C. pauculus* to hospital WPS: in one such report a *C. pauculus* bacteraemia was linked to a contaminated hospital water system (Inkster et al., 2021), while in another a ‘pseudo-outbreak’ at an outpatient clinic was concluded to be due to staff rinsing culture swabs in tap water (Balada-Llasat et al., 2010). Isolation of *C. pauculus* from a hospital sink trap had not previously been reported prior to the Butler et al. (2022) publication.

It is now widely appreciated that culture-based studies do not reflect the true microbial diversity in environmental samples, primarily because we cannot easily mimic the exact growth requirements of environmental bacteria and potentially because of issues with sample acquisition and storage. The use of 16S rDNA amplicon sequencing has led to a better appreciation of extant biodiversity in microbial ecology, for example leading researchers to find that environments such as the deep sea are orders of magnitude more diverse than previously thought (Sogin et al., 2006). This method has also been applied to characterise the taxa present in biofilm material recovered from domestic shower hoses, demonstrating that culture-based studies yield less than 1 % of the flora actually present (Moat et al., 2016). Sequencing especially helps in detecting and identifying difficult-to-culture microorganisms which may be present in abundance (Boers et al., 2019; Chan et al., 2019).

Despite the popularity of the 16S rDNA profiling method, there are very few

## 2.1. INTRODUCTION

---

publications describing 16S rDNA amplicon surveys conducted on hospital sink traps. One study sampled two sink traps from patient rooms in a hospital and sequenced the 16S rRNA gene V4 region, finding that the two trap communities were substantially different from one another with one dominated by *Rhodocyclaceae*, *Comamonadaceae* and an unidentified family while the other was dominated by *Pseudomonadaceae* (Burgos-Garay et al., 2021). Another study sampled sinks (although the specific sink surface sampled was not described) and other surfaces in three hospitals and sequenced the 16S rRNA gene V3–4 region, finding that nurse wagons and sinks ‘bridged’ clusters of *Enterobacteriaceae*, suggesting their contribution to the spread of bacteria within and between hospital wards (Yano et al., 2017). Other related studies have investigated domestic drains (McBain et al., 2003) and a communal sink drain on a university campus (Withey et al., 2021).

Sequencing-based microbial surveys have been further enhanced by new technologies such as the MinION platform, developed and marketed by Oxford Nanopore Technologies (ONT), which is a real-time, long-read sequencing technology allowing in-house processing of samples. Subsequent data analysis is supported by a host of free-to-use, often open source programmes available online and described in the published literature (Brettin et al., 2015; Connor et al., 2016; Wick et al., 2017b; Davis et al., 2019). The MinION platform has been referred to as “third generation” sequencing (Lu et al., 2016), although the fast evolution of the technology and sequencing chemistry has led to a lack of independent benchmarking of the platform’s basecalling accuracy and inter-run variability (Tyler et al., 2018). In general terms, the 16S rDNA sequencing method of microbial profiling is limited by its reliance on a single marker, the 16S rRNA gene, which is fundamentally limited in its resolution among closely

## *2.1. INTRODUCTION*

---

related species (Poretsky et al., 2014), especially if sequencing only 1 or 2 hypervariable regions. While use of the MinION long-read platform to sequence the full length of the 16S rRNA gene can improve this resolution, 16S rDNA sequencing results are expressed at the genus level in this thesis. A further limitation of 16S rDNA sequencing is the incompletely understood bias introduced by the need for PCR amplification of sequences in the sample, as DNA from some bacteria is more efficiently copied during PCR than DNA from others (Hansen et al., 1998; Kennedy et al., 2014; Silverman et al., 2021) and under-represented templates are particularly susceptible to bias due to the greater impact of the stochastic nature of PCR (Chandler et al., 1997). The ability to lyse different bacterial cells may also vary, termed extraction bias, leading to differences in the contribution of bacteria from different genera to the 'pool' of DNA available for sequencing (Salonen et al., 2010; Brooks et al., 2015; Gill et al., 2016; Xue et al., 2018). To balance the strengths and limitations of both culture-dependent and -independent methods, both types of characterisation are presented in this chapter.

### **2.1.1 Aims**

In light of the above introductory information, this project aimed to characterise hospital sink trap flora as a baseline. Therefore, the aim was to apply both culture-dependent and -independent approaches to achieve this.

### **2.1.2 Objectives**

To achieve the above aims, the following objectives were set:

- Characterise the bacteria present in hospital sink traps using molecular approaches by sequencing 16S rDNA amplicons using both short-read and long-read sequencing platforms.
- Culture and identify bacteria recovered from hospital sink traps.
- Utilise methods to further characterise any isolates of interest.

## 2.2 Materials and methods

### 2.2.1 Sample collection

A sink trap of the bottle design was removed from a sink on an acute care ward at a UK hospital in May 2017 by hospital staff, sealed in a sterile sample bag, and transferred to University of Plymouth laboratories where it was stored at  $-20^{\circ}\text{C}$ . This sink trap is referred to as 'archived' due to this period of storage. In 2020, the sink trap was thawed to room temperature (RT) for 1 h before sampling with a sterile swab moistened with Dulbecco A phosphate-buffered saline (PBS) (Thermo Scientific Oxoid, UK). The swab was placed in a tube containing 3 mL PBS, then rotated and vortexed to release swabbed material. The swab was then removed and the suspension pipette mixed and vortexed once again until no large aggregates could be seen. The suspension was serially diluted tenfold to  $10^{-3}$  in PBS.

In 2021, a selection of sink traps ( $n=3$ ) were swabbed (ESwab<sup>TM</sup> with liquid amies preservation medium) by staff at Derriford Hospital (University Hospitals Plymouth NHS Trust) as part of routine pathogen surveillance. Two of the sink traps were located on acute care wards and one was on a general medical ward, all were from handwashing sinks. Swabs were stored at  $4^{\circ}\text{C}$  and transferred to University of Plymouth laboratories within 24 h. Upon arrival at the laboratory, each of the three swabs was placed in a separate 5 mL tube containing 3 mL PBS and swabbed material removed by twisting and pressing the swabs against the tube wall. The total volume (1 mL) of each swab's preservation medium was also transferred to the relevant tube. Aliquots (750  $\mu\text{L}$ ) of each tube (with and without glycerol added to a final concentration of 25% (v/v)) were taken for archiving, before pooling all three samples and mixing well

by pipette and vortexing. An aliquot (750  $\mu$ L), with and without glycerol added, was also taken of the pooled sample. The total pooled volume was added to a 250 mL Erlenmeyer flask containing 50 mL Reasoner's 2A (R2A) broth (prepared in-house identically to Oxoid CM0906, except omitting agar - see Table A.1 on page 291). To enrich bacterial numbers, as has been described previously (Garratt et al., 2021), the flask was incubated at 20 °C with shaking at 100 rpm for 3 d in a normal atmosphere. After 3 d, the broth culture was scaled up to 200 mL in a 1000 mL flask in R2A broth and enrichment continued at 20 °C with shaking at 100 rpm for an additional 3 d in a normal atmosphere. At the end of enrichment, aliquots of the suspension were made for storage in a final concentration of 25 % (v/v) glycerol and stored at -80 °C for use in later experiments. The remaining culture was made up to 900 mL by addition of autoclaved tap water (ATW) from a laboratory cold feed tap and this mixture used for later experiments (see Chapter 5 starting on page 175).

### **2.2.2 Molecular characterisation of the microbial flora recovered from the archived hospital sink trap by MinION 16S rDNA amplicon sequencing**

The following steps refer to processing of the swabs from the sink trap collected and frozen in 2017.

#### **2.2.2.1 DNA extraction from the archived sink trap swab sample**

Metagenomic DNA was extracted from 250  $\mu$ L of the undiluted suspended biofilm in PBS using the DNeasy<sup>®</sup> PowerSoil<sup>®</sup> kit (Qiagen, Germany) according to the manufacturer's instructions. The kit utilises both physical and chemical means



of cell lysis, homogenising the biofilm aggregates in the suspension. Extracted DNA was eluted in 50  $\mu$ L Ambion<sup>TM</sup> nuclease-free water (Invitrogen, MA, USA). Extraction yield was quantified using the Qubit<sup>TM</sup> dsDNA HS Assay Kit (Invitrogen, MA, USA) and fluorometer (Thermo Fisher Scientific, UK), and purity was determined using a Nanodrop<sup>TM</sup> spectrophotometer (Thermo Fisher Scientific, UK).

### 2.2.2.2 MinION 16S rDNA amplicon sequencing

The 16S barcoding kit (SQK-RAB204) was used to generate barcoded 16S rDNA PCR products, according to the manufacturer's instructions. As part of the protocol, a 16S rRNA gene PCR takes place and rapid sequencing adapters are added to the DNA ends to generate the sequencing library. A flow cell (R9.4.1/FLO-MIN106) was removed from storage at 4 °C and left to equilibrate to RT before use. Fresh flow cell priming mixture was prepared according to the manufacturer's instructions (EXP-FLP002; 1 mL containing 30  $\mu$ L flush tether and 970  $\mu$ L flush buffer). The flow cell was primed by adding 800  $\mu$ L of running buffer through the priming port and then left to equilibrate once again at RT for 5 min. The SpotON port was then opened and the final 200  $\mu$ L of running buffer carefully added. The run was prepared by loading 75  $\mu$ L of the library through the SpotON port in a dropwise fashion, ensuring that each drop flowed into the device before the next was added. A standard sequencing protocol was run with default parameters set using MinKNOW on a Dell desktop computer (32 GB RAM, Intel<sup>®</sup> Core<sup>TM</sup> i5-7500, 3.4 GHz). Basecalling was performed by Guppy version 3.4.5 using the Cloud Infrastructure for Big Data Microbial Bioinformatics (CLIMB) platform (Connor et al., 2016).

### 2.2.2.3 Bioinformatic analysis

Nanoplot (De Coster et al., 2018) was used to produce summary statistics on the data. Demultiplexing and adaptor trimming were performed by PoreChop version 0.2.3 (Wick et al., 2017a) with lenient binning settings (barcode threshold set to 60% identity and barcode difference value set to 1.0). This step was repeated to verify that all reads had been demultiplexed and no reads in the “none” output could be reassigned. Filtering of reads was performed by NanoFilt version 2.6.0 (De Coster et al., 2018) with quality initially set to 5, minimum length 1000 bp and maximum length 1500 bp. Taxonomy of filtered reads was assigned by Kraken2 (Wood et al., 2019). The Kraken2 output was analysed and visualised using Pavian (Breitwieser and Salzberg, 2016). This process was repeated systematically with increasing quality thresholds during the NanoFilt step in order to maximise the quality of the data while maintaining an adequately sized dataset; the final quality score of the data presented was 7.

### 2.2.3 Molecular characterisation of the microbial flora recovered from a pooled hospital sink trap sample by Illumina 16S rDNA amplicon sequencing

The following steps refer to processing of the swabs from the sink traps collected in 2021.

#### 2.2.3.1 DNA extraction from hospital sink trap swab samples

Metagenomic DNA was extracted from 250  $\mu$ L of both the pooled and enriched samples using the DNeasy<sup>®</sup> PowerSoil<sup>®</sup> Pro kit (Qiagen, Germany) according to the manufacturer’s instructions. Extracted DNA was eluted in 50  $\mu$ L of the

elution buffer component of the kit. As above, DNA integrity was checked by running on a 1 % TAE gel. Extraction yield was quantified using the Qubit™ ds-DNA HS Assay Kit (Invitrogen, MA, USA) and fluorometer (Thermo Fisher Scientific, UK), and purity was determined using a Nanodrop™ spectrophotometer (Thermo Fisher Scientific, UK). Novogene's quality criteria were  $\geq 200$  ng of genomic DNA in a volume of  $\geq 20$   $\mu\text{L}$  at a concentration of  $\geq 10$   $\text{ng}\mu\text{L}^{-1}$  and an  $A_{260/280}$  ratio of 1.8–2.0.

### 2.2.3.2 Illumina 16S rDNA amplicon sequencing and analysis

Purified metagenomic DNA, as extracted above, which met the quality criteria was provided to Novogene (<https://en.novogene.com>) for PCR amplification, product quantification, purification and pooling, library preparation, and sequencing. The target regions were V3–4 using primers 341F and 806R (Muyzer et al., 1993; Caporaso et al., 2011; Takahashi et al., 2014; Hiergeist et al., 2016) (341F: CCT AYG GGR BGC ASC AG and 806R: GGA CTA CNN GGG TAT CTA AT) and V4–5 using primers 515F and 907R (Caporaso et al., 2011; Armitage et al., 2012; Chen et al., 2017; Edwardson and Hollibaugh, 2018; Hugerth Luisa et al., 2020) (515F: GTG CCA GCM GCC GCG GTA A and 907R: CCG TCA ATT CCT TTG AGT TT). Degenerate primers were based on the IUPAC code. Novogene staff used a proprietary data analysis pipeline to merge and filter data, carry out operational taxonomic unit (OTU) clustering, and finally run analyses such as estimation of alpha and beta diversity. Quality control data are summarised in Table A.4 on page 294.

## 2.2.4 Bacterial culture from hospital sink traps

### 2.2.4.1 Bacterial recovery without selection

Recovery was performed on four types of solid media ranging in nutritional content from minimal to rich; R2A agar, nutrient agar (NA), lysogeny broth agar (LB), and columbia blood agar (CBA) composed of columbia agar (Sigma-Aldrich, MO, USA) with 5% (v/v) defibrinated horse blood (Fisher Scientific, UK). All suspensions, from the neat suspension to the  $10^{-3}$  dilution, were spread plated on all 4 agars in duplicate in 100  $\mu$ L aliquots. All bacteriological media and PBS had been sterilised by autoclaving at 121 °C and 15 psi for 15 min. Agar plates were incubated at either 20 °C or 37 °C for 7 d to maximise the diversity of the bacteria recovered. After 7 d, plates were observed and colony morphologies categorised and numbered. A maximum of 4 replicates per distinct colony morphology were re-streaked onto fresh agar plates and incubated once again in order to provide a pure culture of each isolate. Replicates provided redundancy in case of downstream process failures and also increased certainty of the identity of particular colonies.

### 2.2.4.2 Bacterial recovery with selection

Two rounds of recovery were performed with selection for silver nitrate and ciprofloxacin tolerance, respectively. For ciprofloxacin selection, LB agar was supplemented with between 0.5–8.0  $\mu$ g mL<sup>-1</sup> ciprofloxacin. For silver selection, LB agar was supplemented with between 1–32  $\mu$ g mL<sup>-1</sup> silver nitrate (AgNO<sub>3</sub>). These concentrations were chosen to provide a useful range that would capture potentially resistant isolates. Suspensions above and the same incubation conditions were used. As above, a maximum of 4 replicates per distinct colony

morphology were re-streaked onto fresh agar plates and incubated once again in order to provide a pure streak plate of each isolate.

### 2.2.4.3 DNA extraction, amplification and sequencing of 16S rDNA of single isolates

Genomic DNA was extracted from a loopful of biomass from pure streak plates using the DNeasy<sup>®</sup> PowerSoil<sup>®</sup> kit (Qiagen, Germany) according to the manufacturer's instructions. The final elution step was performed in 50  $\mu$ L of the kit's elution buffer; eluted DNA in buffer was then stored at  $-20^{\circ}\text{C}$ .

Initial identification of isolates was conducted based on the 16S rRNA gene sequence. The full-length gene was amplified by PCR in 50  $\mu$ L reactions consisting of 25  $\mu$ L DreamTaq<sup>™</sup> Green 2X PCR Master Mix (Thermo Fisher Scientific, UK), 5  $\mu$ L DNA template, 2.5  $\mu$ L of each primer (Eurofins Genomics, Luxembourg) at 0.5  $\mu\text{M}$  (27f: 5'-AGA GTT TGA TCA TGG CTC A, 1492r: 5'-TAC GGT TAC CTT GTT ACG ACT T) (Suzuki and Giovannoni, 1996; Hongoh et al., 2003; Frank et al., 2008), and 15  $\mu$ L Ambion<sup>™</sup> nuclease-free water (Invitrogen, MA, USA). A positive control of a known bacterial DNA sample and a negative control of Ambion<sup>™</sup> nuclease-free water in the place of the DNA template were included. The thermocycler programme used was as follows: 5 min at  $94^{\circ}\text{C}$  followed by 30 cycles of 30 s at  $94^{\circ}\text{C}$ , 1 min at  $52^{\circ}\text{C}$ , and 1.5 min at  $72^{\circ}\text{C}$ , followed by 10 min at  $72^{\circ}\text{C}$ . PCR products were stored at  $4^{\circ}\text{C}$ .

The presence and size of PCR products were confirmed by gel electrophoresis, running 5  $\mu$ L of each PCR reaction mixture on a 1.5% agarose TAE gel containing SYBR<sup>™</sup> Safe DNA Gel Stain (Invitrogen, MA, USA). Bands at the appropriate size confirmed the amplification of the 16S rRNA gene.

## 2.2. MATERIALS AND METHODS

---

PCR products were prepared for Sanger sequencing using the ExoSAP-IT™ PCR Product Cleanup Reagent (Thermo Fisher Scientific, UK) according to the manufacturer's instructions. Amplicon sequencing was completed by Biosearch Technologies (LGC Genomics, Germany), and sequences were analysed using Geneious Prime 2021.1.1 for macOS (<https://geneious.com>). Sequence ends were trimmed at a 1 % error threshold and then aligned using the MUSCLE alignment algorithm with default settings. The resulting consensus sequence was used for a search using the Basic Local Alignment Search Tool (BLAST) (<https://blast.ncbi.nlm.nih.gov/Blast.cgi>) against the National Center for Biotechnology Information (NCBI) nucleotide collection.

### 2.2.5 Further investigation of a *Cupriavidus* sp. isolate from a hospital sink trap

The isolate was initially taken forward for further characterisation due to interest in the genus having been described as including multiple emerging human pathogens despite the historical description of *Cupriavidus* spp. in environmental niches. Due to the lack of species resolution from 16S rRNA gene sequencing, whole genome sequencing (WGS) was indicated for identification of the organism and for further characterisation of the genome itself.

#### 2.2.5.1 Draft genome determination of the *Cupriavidus* sp. isolate

ONT MinION sequencing was employed to produce long reads for genome assembly. Genomic DNA was isolated using the DNeasy® Blood & Tissue Kit (Qiagen, Germany) with modifications made for Gram-negative bacteria according to the manufacturer's instructions and precautions taken to reduce shearing of

## 2.2. MATERIALS AND METHODS

---

high molecular weight DNA. These precautions included limiting freeze-thaw cycles, use of wide bore pipette tips, and mixing tubes by flicking rather than vortexing. Extraction yield was quantified using the Qubit™ dsDNA HS Assay Kit (Invitrogen, MA, USA) and fluorometer (Thermo Fisher Scientific, UK), and purity was determined using a Nanodrop™ spectrophotometer (Thermo Fisher Scientific, UK). ONT sequencing was completed using the 1D Native barcoding genomic DNA protocol (SQK-LSK108) and EXP-NBD103 barcoding kit on an R9.4.1 flow cell (FLO-MIN106) according to the manufacturer's instructions. Basecalling was completed using Guppy version 5.0.11 with default settings using the CLIMB platform (Connor et al., 2016).

Illumina next generation sequencing (NGS) was provided by MicrobesNG (<https://microbesng.com>). A single colony of the *Cupriavidus* sp. isolate was intentionally streaked on agar to give a heavy lawn of growth over the majority of the agar plate, with a small streak to the side to ensure purity. The lawn was then harvested and suspended in a tube with cryopreservative (Microbank™, Pro-Lab Diagnostics, UK) according to instructions provided by MicrobesNG. The following DNA extraction and library preparation steps were completed in-house by MicrobesNG: 40 µL of the bacterial suspension was lysed by addition of 120 µL of Tris-EDTA (TE) buffer containing lysozyme (final concentration 0.1 mg mL<sup>-1</sup>) and RNase A (final concentration 0.1 mg mL<sup>-1</sup>) and incubated at 37 °C for 25 min. Proteinase K (final concentration 0.1 mg mL<sup>-1</sup>) and sodium dodecyl sulphate (final concentration 0.5% v/v) were then added and incubated at 65 °C for 5 min. Genomic DNA was purified using an equal volume of solid phase reversible immobilisation (SPRI) beads and resuspended in elution buffer (Qiagen, Germany). DNA was quantified with the Quant-iT dsDNA HS kit (Thermo Fisher Scientific, UK) in an Eppendorf AF2200 plate

reader (Eppendorf UK Ltd, UK). A genomic DNA library was prepared for sequencing using the Nextera XT Library Prep Kit (Illumina, CA, USA) following the manufacturer's protocol with the following modifications: input DNA was increased twofold, and PCR elongation time was increased to 45 s. DNA quantification and library preparation were carried out on a Hamilton Microlab STAR automated liquid handling system (Hamilton Bonaduz AG, Switzerland). Pooled libraries were quantified using the Kapa Biosystems Library Quantification Kit for Illumina. Libraries were sequenced on an Illumina HiSeq using a 250 bp paired-end protocol. Finally, reads were adapter-trimmed using Trimmomatic 0.30 (Bolger et al., 2014) with a sliding window quality cut-off of Q15.

### 2.2.5.2 Hybrid genome assembly and annotation

A hybrid assembled and annotated genome consisting of Illumina short reads and ONT long reads was produced using the Comprehensive Genome Analysis tool provided by the PATRIC 3.6.10 Bioinformatics Resource Center (Davis et al., 2019). Unicycler (Wick et al., 2017b) was selected as the assembly strategy and annotation was completed using the RAST toolkit (RASTtk) (Brettin et al., 2015) with cut-off values of  $\geq 95\%$  identity and  $\geq 70\%$  coverage.

### 2.2.5.3 Antimicrobial susceptibility testing of the *Cupriavidus* sp. isolate

The guidelines provided by the European Committee on Antimicrobial Susceptibility Testing (EUCAST; <https://www.eucast.org>) were followed for completion of minimum inhibitory concentration (MIC) assays by the broth microdilution method. Classification of the isolate's susceptibility to antibiotics was determined based on EUCAST breakpoint tables using entries for *Pseudomonas*



## 2.2. MATERIALS AND METHODS

---

spp. as published previously (Langevin et al., 2011; D’Inzeo et al., 2015; Massip et al., 2020) due to the lack of published breakpoints for *Cupriavidus* spp., as well as pharmacokinetic-pharmacodynamic (PK-PD) breakpoint values which are not species-specific (Ambrose, 2005; Asín-Prieto et al., 2015). All MIC assays were conducted in cation-adjusted Mueller-Hinton II broth (Sigma-Aldrich, MO, USA) in 96-well round-bottom polypropylene microplates (Corning, NY, USA) and results determined visually following  $18 \pm 2$  h static incubation at  $37^\circ\text{C}$ . Antibiotics were purchased from Melford Laboratories (amikacin, amoxicillin, amoxicillin-clavulanate, cefotaxime, colistin), Sigma-Aldrich (ceftazidime, ciprofloxacin, doxycycline, erythromycin, meropenem), Carbosynth (imipenem, relebactam), Fisher Scientific (cefepime), Lonza (gentamicin), and VWR (ceftriaxone). Meropenem, imipenem, ceftazidime, amoxicillin, amikacin, and relebactam were generously supplied by Dr Jonathan Cox (Aston University), while colistin and amoxicillin were generously supplied by Mr Matthew Emery (University of Plymouth). Antibiotic stocks were prepared in sterile deionised water, except erythromycin which was prepared in dimethyl sulfoxide, and stored at  $-20^\circ\text{C}$  until use. A 16:1 ratio of amoxicillin to relebactam was used, as previously reported by Lopeman et al. (2020).

### 2.2.5.4 *Galleria mellonella* infection to determine median lethal dose of the *Cupriavidus* sp. isolate

Larvae of the greater wax moth *Galleria mellonella* were purchased from Livefood UK Ltd. (<https://www.livefoods.co.uk>) and routinely stored in the dark at  $4^\circ\text{C}$  for up to 7 d without food or water until use. Larvae were individually selected by hand to be  $21 \pm 1$  mm in length and healthy, as determined by a uniform cream colour, with no indications of melanisation. Larval length

## 2.2. MATERIALS AND METHODS

---

correlates to weight according to a linear regression, such that a length of  $21 \pm 1$  mm equates to a weight of  $208.2 \pm 22.2$  mg which is within the optimum range (180–260 mg) for determination of median lethal dose ( $LD_{50}$ ) using the *G. mellonella* model (Hesketh-Best et al., 2021). To prepare the *Cupriavidus* sp. inoculum, the isolate was grown overnight in 10 mL LB broth (Fisher Scientific, UK) at  $37^{\circ}\text{C}$  and then centrifuged at  $2,500 \times g$  for 10 min. The pellet was resuspended in 10 mL PBS, before repeating the centrifugation once more to wash the cells, and finally resuspending the pellet in 1 mL PBS. The resulting suspension was tenfold serially diluted and bacterial density was confirmed by viable count assay using the Miles & Misra method (Miles et al., 1938).

Ten larvae were injected per serial dilution of *Cupriavidus* sp. (the groups were  $10^2$ ,  $10^3$ ,  $10^4$ ,  $10^5$ ,  $10^6$ , and  $10^7$  CFU/10  $\mu\text{L}$ ) via the left penultimate pro-leg using a 50  $\mu\text{L}$  Hamilton 750 syringe (Hamilton Company, NV, USA) with a removable 26S gauge needle. A placebo control of sterile PBS accounted for the physical trauma of injection ( $n=10$ ), along with a ‘no manipulation’ control of larvae with no interventions to account for normal survival ( $n=10$ ). Injected larvae were placed into sterile Petri dishes and incubated at  $37^{\circ}\text{C}$  in the dark without food or water for 48 h. After 24 h and 48 h, the percentage of live larvae in each treatment group was recorded. Larvae were recorded as dead when they met at least two of the following criteria: (i) obvious melanisation, (ii) no response to touch, (iii) no correction when rolled on back. For each time point,  $LD_{50}$  was calculated by plotting CFU/larva against percentage live larvae and interpolating the curve for 50%. The mean average of three biological replicates is reported.

### 2.2.5.5 *Cupriavidus* sp. biofilm formation compared to *Pseudomonas aeruginosa* PAO1

The CV solubilisation assay was used to measure the biomass of formed biofilm in microplates according to the methods published previously (O'Toole, 2011; Wand et al., 2012; Shukla and Rao, 2017). *P. aeruginosa* PAO1 was a gift from Dr Jo Fothergill at the University of Liverpool. *Cupriavidus* sp. and *P. aeruginosa* PAO1 were each inoculated in tryptic soy broth (TSB; Sigma-Aldrich, MO, USA) and R2A broth and incubated at 37 °C until log phase. Cultures were then adjusted to  $1 \times 10^6$  CFU mL<sup>-1</sup>, based on pilot data utilising growth curves to relate OD<sub>600</sub> and bacterial density, and 200 µL/well added to wells in flat-bottom 96-well plates (Thermo Scientific Biolite™, UK). There were 12 technical replicates per bacteria-media combination. Outer microplate wells were filled with 200 µL sterile water to exclude any edge effects and negative controls of broth alone were included. Plates were incubated statically at 37 °C or 20 °C for 24–72 h. To quantify biomass of biofilm formed, at each time point plates were washed with dH<sub>2</sub>O to remove nonadherent cells, stained by addition of 200 µL/well 0.1 % (w/v) CV solution and incubated at RT for 20 min. CV was removed by pipette and then wells were washed again with dH<sub>2</sub>O to remove unbound CV. Plates were dried at 60 °C for 30 min before cooling and solubilising CV by addition of 200 µL/well 30 % (v/v) acetic acid and incubating at RT on a shaking platform for 30 min. Plates were read for absorbance at 575 nm using a SPECTROstar Omega (BMG Labtech, UK). The mean absorbance of negative controls was subtracted from that of each experimental well to account for background staining. At each time point, plates not being measured were also refreshed by removing liquid from wells and replacing with 200 µL appropriate fresh media.

### 2.2.6 Statistical analysis

All experiments consisted of three independent biological replicates and at least three technical replicates per group, or more where indicated. Statistical analyses were conducted using GraphPad Prism v9.1.1 for macOS (GraphPad Software, CA, USA). Data were checked for normal distribution using the Shapiro-Wilk test. Two-way ANOVA was conducted on biofilm data, with Sidak's multiple comparisons test. All statistical analyses used a 95 % confidence limit, so that *p*-values equal to or greater than 0.05 were not considered statistically significant.

## 2.3 Results

### 2.3.1 Hospital sink trap 16S rDNA amplicon survey

#### 2.3.1.1 Molecular characterisation of bacterial flora from an archived hospital sink trap using MinION 16S rDNA amplicon sequencing

Long-read MinION sequencing was used to characterise the 16S rDNA amplicon profile of the swabs collected from the archived hospital sink trap. Sequencing was conducted of the entire length of the 16S rRNA gene. The results, showing the 20 genera with the highest read counts, are shown in Figure 2.1. Quality control information can be found in Table A.2 on page 292. The extended list of results can be found in Table A.3 on page 293. Following demultiplexing and quality filtering there were 260 523 reads, of which 260 415 were classified by Kraken2.

### 2.3. RESULTS

---

Together *Pseudomonas* (18.9%), *Escherichia* (15.4%), *Sphingomonas* (9.4%), *Salmonella* (8.8%), *Burkholderia* (5.6%), *Stenotrophomonas* (5.5%), and *Novosphingobium* (5.5%) dominated. It is noteworthy that a significant number of reads from *Cupriavidus* were detected (2.3%), as a strain of *Cupriavidus* sp. was isolated in culture-based studies and is further characterised in Section 2.3.3.

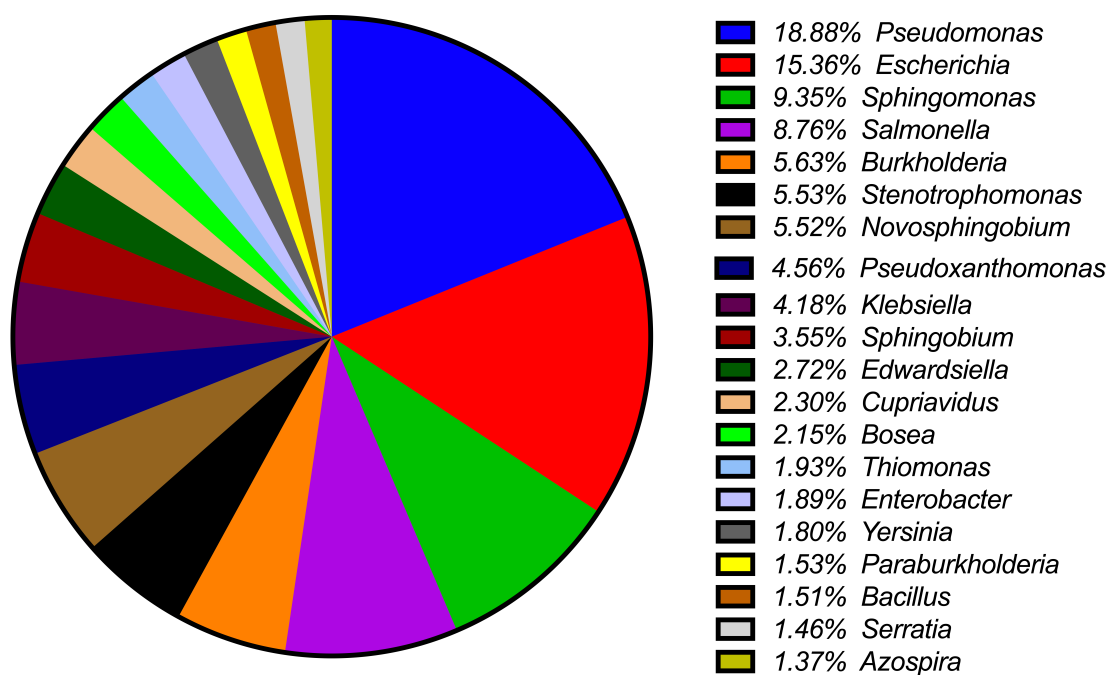

Figure 2.1: 16S rDNA amplicon survey of a hospital sink trap collected in 2017 and archived until sampling in 2020 with long-read MinION sequencing completed. Results are presented at genus-level as a proportion of total reads.

### 2.3.1.2 Characterisation of bacterial flora from pooled hospital sink trap swabs using Illumina 16S rDNA amplicon sequencing

Illumina short-read sequencing of two different 16S rRNA gene regions (V3–4 and V4–5) was conducted to identify the taxa present in a pooled swab sample from a hospital sink trap both as a pooled sample alone and following enrichment in broth (Figure 2.2). Quality control information can be found in Table A.4 on page 294. There were 125 980 and 130 724 raw paired-end reads for pooled and enriched, respectively. Following quality control steps, the number of reads used for classification was 87 185 and 95 136 for pooled and enriched, respectively.

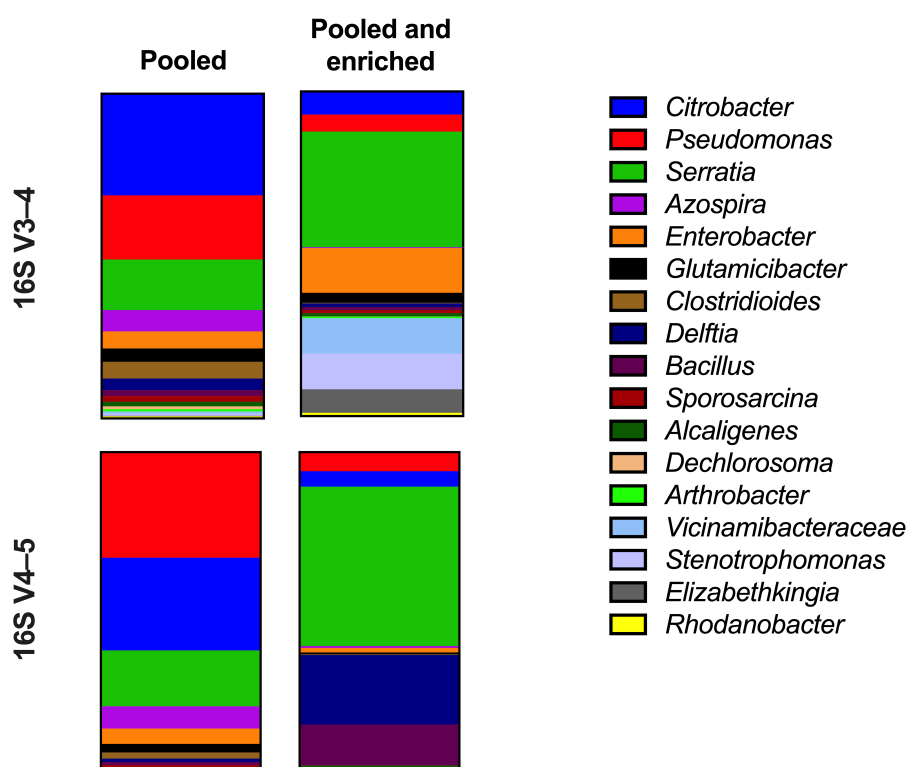

Figure 2.2: 16S rDNA amplicon survey of pooled and enriched hospital sink trap swabs collected in 2021, conducted using Illumina sequencing of two different 16S rRNA gene regions. Results are presented at genus-level as a proportion of total reads.

## 2.3. RESULTS

---

Both *Citrobacter* (31.3% and 28.9%) and *Pseudomonas* (19.8% and 33.0%) dominated in the pooled hospital sink trap community when 16S rRNA gene regions V3–4 and V4–5 were analysed, respectively, although the choice of region did cause a change in the most abundant genus. *Serratia* (15.6% and 17.5%) and *Azospira* (6.6% and 6.9%) were the next two most abundant genera in the pooled sample in both datasets (16S V3–4 and V4–5, respectively). Enrichment caused a significant expansion of *Serratia* as indicated by sequencing of both regions, with V3–4 sequencing indicating an increase from 15.6% to 35.6%, and V4–5 sequencing indicating an increase from 17.5% to 49.8%. The V3–4 region indicated an expansion of *Enterobacter* (from 5.2% to 13.8%), meanwhile the V4–5 region sequencing did not detect any *Enterobacter* reads (0.0%). Sequencing of the V3–4 region also indicated expansion of *Vicinamibacteraceae* and *Stenotrophomonas* while the V4–5 region did not, instead indicating expansion of *Delftia* and *Bacillus*.

### 2.3.2 Bacterial recovery from hospital sink traps

Recovery of bacterial isolates from the different hospital sink trap samples and swabs was performed on agar under different selective conditions. The details of the isolates recovered, their providence, and their selective backgrounds can be found in Table 2.2 below. Isolates were picked from plates, re-streaked on agar, and sent for 16S rRNA gene sequencing for identification which then allowed dereplication of isolates. As not all colonies from all plates were re-streaked, it is possible that other bacteria were recovered but not captured in Table 2.2. Some isolates could only be identified to genus level (*Enterobacter* sp., *Chryseobacterium* sp., and *Leifsonia* sp.) due to multiple BLAST results lacking species resolution.

### 2.3. RESULTS

The archived sink trap from 2017 clearly yielded more diversity than the swabs collected from sink traps in 2021;  $n=9$  distinct genera versus  $n=3$ .

Table 2.2: Bacterial isolates cultured from hospital sink traps with details of any selection background

Source	Isolate	Recovery details
A <sup>a</sup>	<i>Cupriavidus pauculus</i> MF1	CBA <sup>b</sup> with no selection
A	<i>Microbacterium laevaniformans</i>	CBA with 16 µg mL <sup>-1</sup> AgNO <sub>3</sub> <sup>c</sup>
A	<i>Enterobacter</i> sp.	CBA with no selection
A	<i>Chryseobacterium</i> sp.	CBA with no selection
A	<i>Acinetobacter baumannii</i>	LB <sup>d</sup> with 0.5 µg mL <sup>-1</sup> ciprofloxacin
A	<i>Arthrobacter aurescens</i>	CBA with 0.5 µg mL <sup>-1</sup> ciprofloxacin
A	<i>Leifsonia</i> sp.	CBA with 4 µg mL <sup>-1</sup> ciprofloxacin
A	<i>Bacillus cereus</i>	CBA with 4 µg mL <sup>-1</sup> AgNO <sub>3</sub>
A	<i>Bacillus pumilus</i>	CBA with 4 µg mL <sup>-1</sup> AgNO <sub>3</sub>
A	<i>Stenotrophomonas maltophilia</i>	CBA with 16 µg mL <sup>-1</sup> AgNO <sub>3</sub>
B <sup>e</sup>	<i>Citrobacter freundii</i>	CBA with no selection
B	<i>Pseudomonas aeruginosa</i>	CBA with no selection
B	<i>Enterobacter cloacae</i>	CBA with no selection

<sup>a</sup>Source A: sink trap collected in 2017 and archived at -20 °C until swabbing in 2020.

<sup>b</sup>CBA, columbia blood agar.

<sup>c</sup>AgNO<sub>3</sub>, silver nitrate.

<sup>d</sup>LB, lysogeny broth.

<sup>e</sup>Source B: pooled sink trap swabs from Derriford Hospital, collected in 2021.

### 2.3.3 Further investigation of *Cupriavidus pauculus* strain MF1

#### 2.3.3.1 Initial isolation and identification

The isolate appeared as grey, round, easily emulsifiable colonies on CBA (Table 2.2), and Gram-negative bacilli were apparent on staining. Sequencing of the 16S rRNA gene PCR product and subsequent processing yielded a 1392 bp consensus sequence. A BLAST search gave resolution to genus-level, but species-level identification could not be completed due to many 100% identity and 100% query cover matches to multiple *Cupriavidus* species (*C. pauculus*: MW960228, MW049071, MW049067, AY860236, AB109753; *C. taiwa-*



## 2.3. RESULTS

---

*nensis*: EU915716) and multiple sequences identified only to genus level as *Cupriavidus* (GU566329, EU827490, EU596431).

### 2.3.3.2 Draft whole genome sequence

Incorporation of both the Illumina short reads and ONT long reads in a hybrid assembly resulted in a 6.8 Mb draft genome of 5 contigs, with a 'good' quality determination by PATRIC and 0% contamination. The number of coding sequences (CDS) was 6468 – of which 4063 were given functional assignments. PATRIC indicated that the genome is 99.5% complete. No evidence of plasmids was detected. For further details of the hybrid assembly and annotated genome, see Table 2.3.

Table 2.3: Characteristics of the draft genome of *Cupriavidus pauculus* MF1 following hybrid assembly and annotation by PATRIC

Variable	Result
Number of contigs	5
Size (bp <sup>a</sup> )	6 758 723
Contigs N50 (bp)	3 676 674
Contigs L50	1
GC content	63.9%
Completeness	99.5%
Contamination	0%
Coarse consistency	98.4%
Fine consistency	95.4%
CDS <sup>b</sup>	6468
Protein-encoding genes with functional assignment	4063
Protein-encoding genes without functional assignment	2405
tRNA	61
Repeat regions	47
rRNA	12

---

<sup>a</sup>Base pairs.

<sup>b</sup>Coding sequences.

### 2.3. RESULTS

---

Multi-locus sequence typing (MLST) using the autoMLST web tool

(<https://automlst.ziemertlab.com/>) gave the closest match as 98.2 % average nucleotide identity (ANI) to *C. pauculus* KF709 (NBRC 110672) (Watanabe et al., 2015). As the ANI cutoff for new prokaryotic species is 95 % (Hoeiby et al., 2010; Moradali et al., 2017), the isolate was concluded to be part of the existing species *C. pauculus*. To confirm the MLST classification, the Genome-to-Genome Distance Calculator provided by the Leibniz Institute DSMZ was used to run a digital DNA-DNA hybridisation (DDH) to mimic DDH *in silico* (Ciofu and Tolker-Nielsen, 2019). This tool uses three independent formulae, reporting three DDH values. The results were 73.8 %, 85.4 %, and 78.5 % (mean 79.2 %) against the closest match, *C. pauculus* KF709 as above. A DDH value of  $\geq 70\%$  is recommended as the threshold for definition of members of the same species (Goris et al., 2007; Klockgether et al., 2010), thus on this basis the isolate was confirmed to be part of the existing species *C. pauculus*. The strain identifier was designated 'MF1'.

The Rapid Annotation using Subsystem Technology tool kit (RASTtk) was used within PATRIC to identify a number of antibiotic resistance genes (ARGs), virulence factor genes (VFs), and metal resistance genes (MRGs) with cut-off values of  $\geq 95\%$  identity and  $\geq 70\%$  coverage. The full list of the genes of interest within these categories can be found in Table 2.4. In total, 12 ARGs, 8 VF genes, and 33 MRGs were identified. Multiple  $\beta$ -lactamase genes (*AmpC* and *bla<sub>OXA</sub>*) and a colistin resistance determinant (*arnT*) were identified, with the remaining ARGs encoding efflux pump components. Collectively, the MRGs listed in Table 2.4 have the potential to confer resistance to copper, silver, magnesium, cobalt, mercury, molybdenum, arsenic, zinc, cadmium, iron, antimony, and nickel.

## 2.3. RESULTS

Table 2.4: Genes of interest found within the *C. pauculus* MF1 draft genome following hybrid assembly and annotation by PATRIC

Gene type	Gene name	Gene product/function
Antibiotic resistance genes	<i>AmpC</i> <i>adeF, adeG</i> <i>arnT</i> <i>bla<sub>OXA</sub></i> <i>ceoB</i> <i>EmrAB-TolC</i> <i>H-NS</i> <i>MacA, MacB</i> <i>MdtABC-TolC</i> <i>MexAB-OprM</i>	$\beta$ -lactamase RND multidrug efflux pump Aminoarabinose transferase Class D $\beta$ -lactamase Component of CeoAB-OpcM efflux pump Multidrug efflux system Regulates expression of multidrug exporter Form an efflux complex with TolC Multidrug efflux system Multidrug efflux system
Virulence factors	<i>argG</i> <i>aroC</i> <i>hfq</i> <i>leuB</i> <i>ppsA</i> <i>recA</i> <i>rpoE</i> <i>trpG</i>	Argininosuccinate synthase Chorismate synthase RNA chaperone 3-isopropylmalate dehydrogenase Phosphoenolpyruvate synthase DNA repair and maintenance RNA polymerase sigma E Forms an efflux complex with TolC
Metal resistance genes	<i>acr3</i> <i>arsH</i> <i>cbtA</i> <i>cnrR, cnrY</i> <i>cobS-T, cobN, cobW</i> <i>copC-D, copZ</i> <i>corA, corC</i> <i>cusA-C, cusR-S</i> <i>cutE</i> <i>czcA-D, czcl, czcN</i> <i>merP, merR, merT</i> <i>modA-C</i> <i>nikR</i>	Transmembrane arsenite transporter Methylarsenite oxidase Putative cobalt transporter subunit Nickel and cobalt resistance Cobalt chelataes Copper/silver chaperone and sequestration Na <sup>+</sup> -dependent Mg <sup>2+</sup> transporters Copper and silver resistance Copper transport Cadmium, zinc, and cobalt efflux Mercury resistance Components of molybdate uptake operon Transcriptional regulator of nikABCDE operon

### 2.3.3.3 Antimicrobial susceptibility testing

The MICs of a range of antibiotics against *C. pauculus* MF1 and the resulting susceptibility classifications can be found in Table 2.5. As breakpoint tables for the *Cupriavidus* genus are not available from EUCAST, susceptibility classifica-

### 2.3. RESULTS

tions were based on breakpoints for *Pseudomonas* spp. as has been published previously (Langevin et al., 2011; D’Inzeo et al., 2015; Massip et al., 2020) and EUCAST PK-PD data. PK-PD breakpoints are not species-specific.

Table 2.5: Minimum inhibitory concentrations of antibiotics against the *Cupriavidus pauculus* MF1 isolate and resulting susceptibility classifications

Antibiotic	MIC <sup>a</sup> ( $\mu\text{g mL}^{-1}$ )	Classification ( <i>Pseudomonas</i> spp.)	Classification (PK-PD) <sup>b</sup>
Cefotaxime	1	N/A <sup>c</sup>	Susceptible
Ceftazidime	8	Intermediate <sup>*d</sup>	Intermediate
Cefepime	0.25	Intermediate <sup>*</sup>	Susceptible
Meropenem	>512	Resistant	Resistant
Imipenem	0.5	Intermediate <sup>*</sup>	Susceptible
Imipenem- Relebactam (2:1)	0.25	Susceptible	Susceptible
Amoxicillin	>512	N/A	Resistant
Amoxicillin- Relebactam (16:1)	16	N/A	N/A
Amoxicillin- Clavulanate (5:1)	64	N/A	Resistant
Gentamicin	512	IE <sup>e</sup>	Resistant
Amikacin	512	Resistant	Resistant
Ciprofloxacin	0.125	Intermediate <sup>*</sup>	Susceptible
Erythromycin	32	N/A	IE
Doxycycline	0.25	N/A	IE
Colistin	16	Resistant	IE

<sup>a</sup>Where any set of results contained differences of more than one serial dilution step, the assays were repeated. Shown are the consensus (*i.e.* mode) results of three biological replicates; alternatively, the midpoint was used if the three results were within one serial dilution step of each other.

<sup>b</sup>PK-PD, pharmacokinetic-pharmacodynamic.

<sup>c</sup>‘N/A’ indicates that a breakpoint is not available.

<sup>d</sup>Intermediate with an asterisk (\*) indicates that an ‘arbitrary off scale’ breakpoint is given by EUCAST.

<sup>e</sup>‘IE’ indicates that EUCAST state that there is insufficient evidence to consider a particular antibiotic as a therapy and so give no breakpoint.

### 2.3. RESULTS

---

The MIC results in Table 2.5 indicate that *C. pauculus* MF1 is susceptible to the cephalosporins cefotaxime, ceftazidime and cefepime. Regarding carbapenems, meropenem resistance was clear, however, susceptibility to imipenem was seen with limited additional benefit conferred by the  $\beta$ -lactamase inhibitor relebactam. The strain was resistant to amoxicillin, but susceptibility could be increased to an extent by addition of the  $\beta$ -lactamase inhibitors relebactam or clavulanate, which reduced the MIC by over 32-fold and 8-fold, respectively. The isolate appeared to be susceptible to both ciprofloxacin, a fluoroquinolone, and doxycycline, a tetracycline. High MICs were found for the aminoglycosides gentamicin and amikacin. The MIC of erythromycin, a macrolide, appeared high, however classification was not possible due to the lack of a published breakpoint. The isolate could be classified as resistant to the crucial ‘antibiotic of last resort’, colistin.

The phenotypic antibiotic resistance profile of *C. pauculus* MF1 in Table 2.5 can be correlated with its genotypic antibiotic resistance profile through the combination of MIC and WGS data (Table 2.6). Suggested explanations for each antibiotic resistance phenotype can be offered by one or more mechanisms identified by WGS.

### 2.3. RESULTS

---

Table 2.6: Correlation of phenotypic resistance and genotypic resistance determinants in *Cupriavidus pauculus* MF1, offering a suggested explanation for its antibiotic susceptibility profile.

Demonstrated phenotypic resistance	Suggested genotypic resistance determinant(s) responsible and mechanism
Meropenem	<i>MexAB-OprM</i> , by efflux and/or degradation by <i>bla<sub>OXA</sub></i> <sup>a</sup>
Amoxicillin	<i>AmpC</i> and <i>bla<sub>OXA</sub></i> , by degradation <sup>b</sup>
Gentamicin and amikacin	Alterations of the ribosomal protein S12 gene <sup>c</sup> , or <i>arnT</i> , by addition of cationic groups to lipopolysaccharides resulting in bacterial charge modification <sup>d</sup>
Colistin	<i>arnT</i> , by addition of cationic groups to lipopolysaccharides <sup>e</sup>

<sup>a</sup>Codjoe and Donkor (2017)

<sup>b</sup>Féria et al. (2002)

<sup>c</sup>Finken et al. (1993)

<sup>d</sup>Tavares-Carreón et al. (2016)

<sup>e</sup>Lin et al. (2014)

#### 2.3.3.4 Median lethal dose in *Galleria mellonella* larvae

The lethality of *C. pauculus* MF1 infection was investigated by determining LD<sub>50</sub> following injection of *G. mellonella* larvae with inocula of a range of bacterial densities.

The 24 h LD<sub>50</sub> of *C. pauculus* MF1 in *G. mellonella* larvae was determined to be  $2.54 \times 10^7$  CFU/larva (SD $\pm 5.99 \times 10^6$ ) while the 48 h LD<sub>50</sub> was determined to be  $2.64 \times 10^6$  CFU/larva (SD $\pm 1.82 \times 10^6$ ). The average weight of larvae used was 208.2 mg, therefore these LD<sub>50</sub> values equate to  $1.22 \times 10^5$  CFU mg<sup>-1</sup> (24 h) and  $1.27 \times 10^4$  CFU mg<sup>-1</sup> (48 h).

### 2.3.3.5 Biofilm formation compared to *Pseudomonas aeruginosa* PAO1

The formation of biofilm by *C. pauculus* MF1 was compared to that of *P. aeruginosa* PAO1 in a microtitre plate format and quantified using the crystal violet solubilisation assay.

Both *C. pauculus* MF1 and *P. aeruginosa* PAO1 formed detectable biofilms in minimal (R2A) and rich (TSB) broth at both physiological (37 °C) and environmental (20 °C) temperatures between 24–72 h (Figure 2.3).

In R2A broth at 37 °C, *C. pauculus* biofilm significantly overtook that of *P. aeruginosa* after 48 h and 72 h (Figure 2.3A). In R2A broth at 20 °C, *P. aeruginosa* formed much more biofilm than in the same medium at 37 °C, approaching maximum detectable signal (3.5) after only 24 h, while *C. pauculus* biofilm built gradually across the 72 h but did not overtake that of *P. aeruginosa* (Figure 2.3B).

In general terms, the amount of biofilm formed in TSB conditions was greater than in R2A conditions. In TSB at 37 °C, *C. pauculus* biofilm levels started low at 24 h but reached similar levels to *P. aeruginosa* by 72 h (Figure 2.3C). In TSB at 20 °C, *P. aeruginosa* biofilm reached similar levels as at 37 °C from 48 h onwards, but at 24 h showed clearly less biofilm than at 37 °C (Figure 2.3D). *C. pauculus* biofilm formation in TSB at 20 °C built consistently across the 72 h, but did not reach the same level as *P. aeruginosa* biofilm (Figure 2.3D).

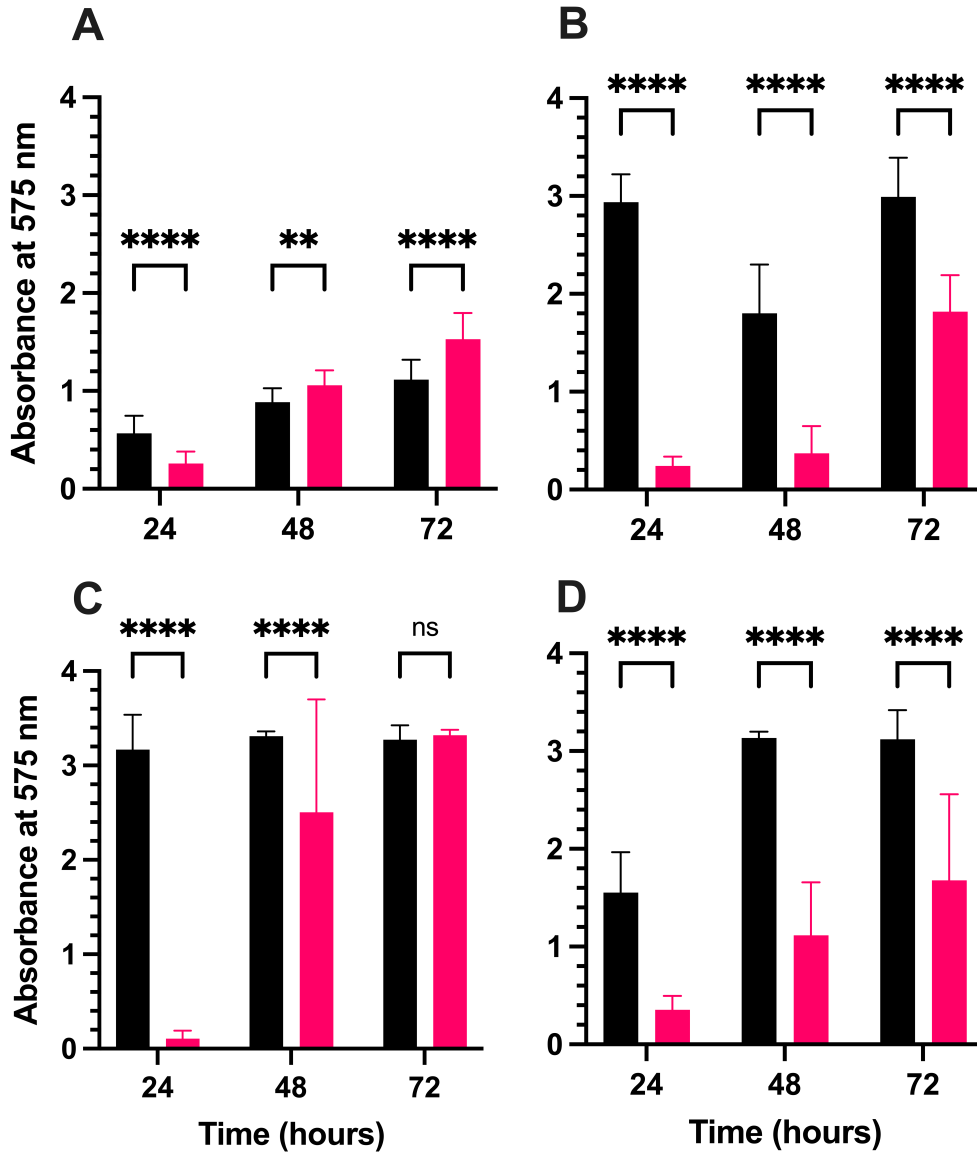

Figure 2.3: Biofilm formation by *C. pauculus* MF1 (pink) and *P. aeruginosa* PAO1 (black) in R2A broth at either 37 °C (A) or 20 °C (B) and in TSB at either 37 °C (C) or 20 °C (D) over 72 h as determined by the CV solubilisation assay. Data presented as mean  $\pm$  standard deviation. \*\*\*\*  $p < 0.0001$ , \*\*  $p < 0.01$ , ns: not significant; two-way ANOVA with Sidak's multiple comparisons test. Data presented are the average of  $n=3$  biological replicates.



## 2.4 Discussion

### 2.4.1 16S rDNA sequencing of hospital sink trap samples

Bacterial 16S rRNA genes contain nine ‘hypervariable regions’, designated V1–V9, that demonstrate significant sequence diversity between bacteria (Chakravorty et al., 2007). These regions are interleaved with highly conserved regions which serve as ‘anchors’ for the use of universal PCR primers (Fuks et al., 2018). Priming of the conserved regions, amplification and subsequent sequencing of the hypervariable regions has successfully been used as a strategy to identify bacteria and perform taxonomic studies of both environmental and clinical samples for some years (Choi et al., 1996; Schmalenberger et al., 2001; Clarridge, 2004; Loong et al., 2016). However, there have been few published studies utilising 16S rDNA sequencing to characterise the bacterial flora of hospital sink traps.

Sequencing of 16S rDNA amplicons was conducted using DNA purified from swabs of an archived hospital sink trap, from more recent swabs of three hospital sink traps, and from an enriched community of bacteria cultured from the latter hospital sink trap swabs. The major difference between MinION and Illumina-based approaches to 16S rDNA amplicon sequencing is the length able to be sequenced. As MinION is capable of long-read sequencing, virtually the entire 16S rRNA gene can be sequenced. However, Illumina is a short-read platform, and so regions of the 16S rRNA gene must be selected for sequencing. There is precedent for use of either the V3–4 (Klindworth et al., 2012) or V4–5 (Parada et al., 2016) regions, with some studies finding that the two regions are highly similar in representing total microbial community composition down to genus level (Fadeev et al., 2021), and so both were sequenced in this

## 2.4. DISCUSSION

---

work to allow comparison and to avoid loss of any particular taxa.

The archived sink trap from 2017, which had been stored at  $-20^{\circ}\text{C}$  until sampling in 2020, was dominated by *Pseudomonas*, *Escherichia*, *Sphingomonas* and *Salmonella* (Figure 2.1 on page 84). It is noteworthy that *Cupriavidus* was present at sufficient read numbers to be represented in the top level analysis, given that *C. pauculus* was isolated in the culture-based investigation and characterised further. As MinION sequencing was used to analyse this sample, the entire length of the 16S rRNA gene was sequenced: however while this has been suggested by some authors to provide species-level resolution (Matsuo et al., 2021), a cautious approach was taken here and analysis was conducted at genus-level. It is likely that sequencing of the full length of the gene contributes to better resolution between closely related genera (Matsuo et al., 2021), so the benefits of MinION sequencing are not lost by analysing results at genus-level.

The storage of the archived sink trap between collection and sampling is inevitably likely to have had some impact on the results, although the extent of this impact is difficult to predict. Due to the nature of metagenomic DNA extraction and sequencing, the culturability of bacteria is less relevant and so it is likely that as long as nucleic acids are undisturbed, uncontaminated, and stored correctly to prevent degradation, the 16S profile should not drift too significantly from its original point. Some authors suggest that microbial community profiles can be well-preserved under freezing conditions and may only undergo significant changes when subjected to suboptimal conditions (Zhao et al., 2011; Cardona et al., 2012; Rubin et al., 2013). Hang et al. (2014) showed that storage at  $37^{\circ}\text{C}$  caused substantial degradation of 16S rDNA, while storage at temperatures of  $4^{\circ}\text{C}$  or lower significantly improved 16S rDNA integrity. Car-

## 2.4. DISCUSSION

---

dona et al. (2012) also indicated that DNA and RNA degradation occurred when frozen samples were defrosted for 1 h before nucleic acid extraction, raising the possibility that the thawing of the archived sink trap prior to sampling in this work may have led to 16S rDNA degradation. Overall, the characterisation of the archived trap formed part of methods development work during this project made feasible by the availability of the sink trap, and was followed up by sampling of hospital sink traps without a storage period.

The samples collected from three hospital sink traps in 2020, which were pooled and DNA extracted without any significant storage interlude, were dominated by *Citrobacter*, *Pseudomonas*, *Serratia*, and *Azospira* (Figure 2.2 on page 85). The use of V3–4 versus V4–5 primers produced some small differences, the most obvious of which is the greater abundance of *Pseudomonas* and reduced abundance of *Citrobacter* in the V4–5 group compared to the V3–4 group. However the next two most abundant genera (*Serratia* and *Azospira*) did not seem affected by this.

Overall, the findings, from both culture-dependent and -independent work, that hospital sink traps were dominated by commonly pathogenic genera such as *Pseudomonas*, *Citrobacter*, *Serratia*, *Escherichia*, *Klebsiella*, *Clostridioides*, and *Enterobacter* are consistent with previously published reports in the literature (Zhou et al., 2016; Regev-Yochay et al., 2018; Decraene et al., 2018; Franco et al., 2020; Kotay et al., 2020; De Geyter et al., 2021). As described in Section 2.1, species of *Pseudomonas*, *Citrobacter*, *Serratia*, *Escherichia*, *Klebsiella* and *Enterobacter* have all been associated with nosocomial disease outbreaks linked to hospital WPS (Hota et al., 2009; Hong et al., 2012; Lowe et al., 2012; Starlander and Melhus, 2012; Kotsanas et al., 2013; Roux et al., 2013; Knoester et al., 2014; Walker et al., 2014; De Jonge et al., 2019). Spores

## 2.4. DISCUSSION

---

of *Clostridioides difficile* have been described in wastewater, leading to community acquisition prior to hospital admission (Moradigaravand et al., 2018), however information relating *C. difficile* to hospital WPS in particular has been difficult to locate. One study did find that *C. difficile* spores persisted in toilet bowl water after 24 flushes, and production of both droplets and aerosols containing *C. difficile* were evident following flushes (Aithinne et al., 2019). As a spore-forming organism, *C. difficile* has the capacity to persist in clinical environments and resist disinfection (Joshi et al., 2017; Dyer et al., 2019). However, as an anaerobe, *C. difficile* may be less able to compete with other organisms which undergo the stages of growth, colonisation and biofilm formation to persist in a hospital sink trap or WPS.

The 16S rDNA sequencing results clearly show that the enrichment step performed using pooled samples inoculated in R2A broth, to expand bacterial cell numbers for later experiments, significantly favoured the growth of *Serratia* and *Delftia* and led to reductions in *Citrobacter* and *Pseudomonas*. Another noticeable difference is in the abundance of *Enterobacter*, which appears to have expanded as a result of enrichment in the V3–4 group, but is indicated as actually having reduced in the V4–5 group. The V3–4 sequencing also indicated expansion in abundance of *Enterobacter*, *Stenotrophomonas*, *Vicinamibacteraceae* and *Elizabethkingia* which was not mirrored in the V4–5 sequencing, where *Delftia* and *Bacillus* were found to have expanded. These data indicate that there are indeed differences in results dependent on the region of the 16S rRNA gene selected, which may be due to the particular genera present in hospital sink traps and their differing resolution by the different types of 16S rDNA sequencing. This is in contrast to the results published by Fadeev et al. (2021), which suggested the two regions similarly represent microbial community com-

position, however that study was conducted on arctic microbial communities and so represented a very different environment.

### 2.4.2 Bacterial recovery from hospital sink traps

Recovering bacteria from an environmental sample using culture-based methods is fundamentally more biased than culture-independent methods, and is limited in its ability to capture all taxa present. An obvious mismatch between the molecular and culture-based approaches (comparing Figure 2.1 with Table 2.2) is the large abundance of *Pseudomonas*, *Escherichia*, *Sphingomonas*, *Serratia*, *Azospira* and *Salmonella* in the 16S rDNA sequencing of the archived sink trap, whereas none of these genera were isolated in the culture-based work. The most straightforward explanation for this is the storage of the archived sink trap at  $-20^{\circ}\text{C}$  for around 3 years before sampling was conducted. As the freezing took place without any cryoprotection, and there are likely to have been at least a small number of freeze-thaw cycles over the 3 years while materials were transferred between laboratory storage areas, a significant loss of bacterial viability and culturability is likely to have taken place. Regarding culture from the pooled hospital sink trap swabs which were taken and transferred within 24 h to the laboratory, significantly higher numbers of bacteria were cultured (although this was not quantified as part of the colony picking process), however this did not translate into more genera being represented in the results. It is likely that a more careful process using a wider range of media, including some more selective media, coupled with generally picking more colonies and sequencing more replicate isolates would have yielded a greater total number of different genera. Visual picking of colonies during bacterial recovery is limited by the fact that strains may display different morphologies on different media,

## 2.4. DISCUSSION

---

and different bacteria may appear to have such similar morphologies as to be indistinguishable by the naked eye (Koch et al., 2021). However this was not a focus, as the 16S rDNA sequencing conducted was seen to provide sufficient characterisation data of the bacteria present in sink traps.

Further investigation of the 16S rDNA amplicon survey results, and comparison with the culture-dependent work, revealed that all cultured isolates' genera were represented in the 16S rDNA survey results, albeit in some cases at relatively low read counts meaning they were not shown in figures - this was particularly the case for the archived sink trap. Culture from the pooled sink traps (without a long-term storage interlude) led to isolation of the top genera shown in Figure 2.2 (*Citrobacter*, *Pseudomonas*, *Enterobacter*, although *Serratia* and *Azospira* were not cultured). The top genera from the archived sink trap 16S rDNA survey were not cultured (*Pseudomonas*, *Escherichia*, *Sphingomonas*, *Salmonella*, *Burkholderia*), although the sixth highest read count genus, *Stenotrophomonas*, was cultured (*Stenotrophomonas maltophilia*). This reinforces the hypothesis that the storage interlude that the archived sink traps were exposed to led to a reduction in culturability of the bacteria present. This conclusion does rely on the major genera identified in the 16S rDNA amplicon sequencing results being cultivable on the media used. More generally, these results reinforce the point that 16S rDNA sequencing reveals greater diversity present than culture, and its sensitivity is demonstrated by the fact that all cultured isolates were also detected by sequencing. In short, no hidden diversity was revealed by culture that was not also revealed by 16S rDNA amplicon sequencing, reinforcing its utility and the need for it to be conducted.

Some isolates, such as *Microbacterium laevaniformans* and *Stenotrophomonas maltophilia*, were able to grow on media containing relatively high concentra-

tions of silver nitrate ( $16 \mu\text{g mL}^{-1}$ ), suggesting metal resistant bacteria may be present in hospital sink traps. Silver resistance has previously been reported in *Stenotrophomonas maltophilia* (Brooke, 2012), however, no reports of silver resistance in *Microbacterium laevaniformans* have been located. Further characterisation of these isolates could be carried out to identify whether they carry resistance determinants such as the *Sil* genes (Sutterlin et al., 2014). The presence of metal resistance genes in sink trap bacterial communities may be problematic as resistance could emerge when selective pressure is applied; this can be investigated by challenging antimicrobial nanocoatings with a multispecies inoculum derived from hospital sink traps, as is described later in this thesis (Chapter 5).

### 2.4.3 *Cupriavidus pauculus* MF1

*C. pauculus* can be described as an emerging human pathogen, apparently making a transition in some cases from chiefly soil and aquatic environments (Watanabe et al., 2015; Feng et al., 2019) into causing opportunistic infections in humans (Langevin et al., 2011; Almasy et al., 2016; Bianco et al., 2018). The species' nature as an emerging pathogen, as well as the commonly reported metal resistance in the genus (von Rozycki and Nies, 2009; Ramirez et al., 2014; Putonti et al., 2018; Huang et al., 2019; Massip et al., 2020), were the factors leading to further work into this strain here. As sink traps are a niche known to act as a reservoir of pathogens in clinical settings, it is possible that the isolation of an emerging pathogen in a sink trap could suggest the possibility of that pathogen's role in nosocomial transmission. By investigating the whole genome sequence of the isolate as well as its antimicrobial susceptibility, virulence in an *in vivo* model, and biofilm formation in relevant conditions

## 2.4. DISCUSSION

---

compared to a well-characterised biofilm-forming model organism, the aim was to assess whether the isolate found in the sink trap could pose a risk to human health.

WGS was indicated due to the lack of species resolution provided by 16S rDNA sequencing, as well as allowing a more in-depth view of the organism. A hybrid approach combining both Illumina short-reads and ONT MinION long-reads allowed a more complete genome to be assembled, and at the time of publication of Butler et al. (2022) the genome added to only six others available for *C. pauculus* - two of which were PacBio/Illumina hybrid assemblies. At the time of writing, additional assemblies have been submitted to NCBI to bring the total number of *C. pauculus* assemblies up to 10. Of these, 3 were submitted by the US Food and Drug Administration (FDA) as part of the FDA-ARGOS project (Sichtig et al., 2019). Those submitted as part of the FDA-ARGOS project were all PacBio/Illumina hybrid assemblies with 3, 4, and 6 contigs (assemblies GCA\_008693385.1, GCA\_003854935.1 and GCA\_019931045.1, respectively). At the time of publication of Butler et al. (2022), the numbers of contigs for the other assemblies available were 227 (GCA\_000974605.1), 111 (GCA\_008801835.1), 38 (GCA\_002858765.1), and 37 (GCA\_019795205.1). Since then, two further assemblies have been added (GCA\_022179805.1 and GCA\_022879635.1) with 38 and 4 contigs, respectively, the former an Illumina assembly and the latter a MinION/Illumina hybrid as with *C. pauculus* MF1. Of all assemblies mentioned, those with <10 contigs are exclusively hybrid assemblies implementing either ONT MinION or PacBio long-read sequencing, highlighting the utility of long-reads in bacterial genome assembly, although with no clear difference in outcome between the two long-read sequencing methods.

WGS allowed annotation of ARGs, most of which were found to be components



## 2.4. DISCUSSION

---

of efflux pumps (*adeG*, *EmrAB-TolC*, *MdtABC-TolC*, *MexAB-OprM*, *MacA/MacB*) along with some  $\beta$ -lactamases (*AmpC*, *bla<sub>OXA</sub>*). The detection of these ARGs in the genome was backed up by the evident phenotypic resistance to meropenem, amoxicillin, amikacin, gentamicin, and colistin. The use of  $\beta$ -lactamase inhibitors (relebactam and clavulanate) with amoxicillin and the resulting reduced MIC reinforced suggestion that some ABR was due to  $\beta$ -lactamase production. The isolate did show susceptibility to cefotaxime, cefepime, imipenem, and ciprofloxacin. In broad terms, the antibiotic susceptibility profile matched that reported for *C. pauculus* by Massip et al. (2020), except in the cases of meropenem and amikacin where higher rates of resistance were evident in *C. pauculus* MF1 ( $>512 \mu\text{g mL}^{-1}$  here versus  $16\text{--}64 \mu\text{g mL}^{-1}$  reported and  $512 \mu\text{g mL}^{-1}$  here versus  $8\text{--}128 \mu\text{g mL}^{-1}$  reported, respectively). The MICs reported by Massip et al. (2020) were based on 37 epidemiologically unrelated *Cupriavidus* clinical strains, suggesting commonality between *C. pauculus* MF1 and *Cupriavidus* clinical isolates.

Colistin resistance is particularly impactful as colistin (polymyxin E) has been revived for the management of Gram-negative multidrug-resistant infections and is known as an antibiotic of last resort (Falagas and Kasiakou, 2005). Colistin resistance is predominantly conferred by either intrinsic mechanisms or through chromosomal mutations. Intrinsic mechanisms such as constitutive expression of the *arnBCADTEF* operon and/or the *eptB* gene, causing addition of phosphoethanolamine and/or 4-amino-4-deoxy-L-arabinose cationic groups to lipopolysaccharides (LPS), as in the cases of *Proteus mirabilis* and *Serratia marcescens* (Aquilini et al., 2014; Lin et al., 2014). These cationic modifications increase the charge of LPS, the target of colistin, and therefore decrease colistin binding. Chromosomal mutations conferring colistin resistance tend to

## 2.4. DISCUSSION

---

have the same or similar mechanism, based around cationic modification of LPS to reduce colistin binding (Laurent et al., 2017). In addition to intrinsic resistance and chromosomal mutations, the threat of dissemination of colistin resistance via the mobilised colistin resistance (*mcr*) genes, which are becoming increasingly prevalent due to plasmid-mediated spread, is a further concern (Ling et al., 2020; Hussein et al., 2021). However, none of the known *mcr* genes were identified in the *C. pauculus* MF1 genome. Colistin resistance in *C. pauculus* MF1 can be explained by the presence of an *arnT* homologue with 81 % identity and 99 % query cover against that reported in *C. metallidurans* CH34 (Massip et al., 2020). Homologues of *arnT* have also been described in *C. pauculus*, *C. basilensis*, *C. necator*, and *C. taiwanensis* as the cause of colistin resistance (Massip et al., 2020).

A large complement of MRGs ( $n=33$ ) were annotated through WGS and together have the potential to contribute to resistance to copper, silver, magnesium, cobalt, mercury, molybdenum, arsenic, zinc, cadmium, iron, antimony, and nickel. Many of these genes confer metal resistance by facilitating sequestration and export of metal ions, for example in the case of *CopZ* with  $\text{Cu}^+$  ions (Radford et al., 2003),  $\text{Ag}^+$  and  $\text{Cd}^{2+}$  ions (Kihlken et al., 2008). The genus *Cupriavidus* is generally known as being metal-tolerant or metal-resistant, with many species including *C. pauculus* (Ramirez et al., 2014; Putonti et al., 2018), *C. metallidurans* (von Rozycki and Nies, 2009; Mazhar et al., 2020), *C. gilardii* (Huang et al., 2019), *C. campinensis* (Abbaszade et al., 2020) and *C. neocaledonicus* (Klonowska et al., 2020) having published metal resistance. Antibiotic resistance and metal resistance are related in a sense, as ARGs and MRGs can co-locate on the same mobile genetic elements. One example is the integrative conjugative element (ICE) termed *Hs1*, which contains 83 genes, including

## 2.4. DISCUSSION

---

both ARGs and MRGs (Bhatt et al., 2018). As ICEs are self-transmissible and carry machinery for their own excision, transfer and integration (Johnson and Grossman, 2015), the co-location of ARGs and MRGs contributes to AMR as either metal or antibiotic-based stress will select for isolates carrying ICEs (Pal et al., 2017). The existence of metal resistance and its association with ABR should not necessarily exclude the use of metal-based antimicrobial therapies, as a 'One Health' approach to AMR is needed where contributions from many different approaches complement each other. Resistance can be considered to be inevitable, regardless of the antimicrobial considered, and so it is important to bear this in mind whenever designing or testing a new antimicrobial approach. The emergence of resistance in future, although inevitable, must be managed through appropriate stewardship of antimicrobials (Cunha and Opal, 2018; Rice, 2018).

The virulence of *C. pauculus* MF1 was considered in two ways: LD<sub>50</sub> in *G. mellonella* larvae and biofilm formation in different conditions compared to *P. aeruginosa* PAO1. The 24 h LD<sub>50</sub> of around 10<sup>7</sup> CFU/larva reported here for *C. pauculus* MF1 is around the same level as that reported for non-pathogenic *E. coli* DH5 $\alpha$  (Alghoribi et al., 2014). This suggests that *C. pauculus* MF1 exhibits low levels of virulence, although this conclusion only extends as far as the *G. mellonella* model under the conditions described. By comparison, *G. mellonella* are particularly susceptible to killing by *P. aeruginosa* with a reported LD<sub>50</sub> of only 10 CFUs (Jarrell and Kropinski, 1982). Some *Burkholderia* spp., which are in the family *Burkholderiaceae* with *Cupriavidus*, have 48 h LD<sub>50</sub>s of 1–30 CFU/larva in the case of *Burkholderia cepacia* or of 9  $\times$  10<sup>2</sup>–2  $\times$  10<sup>5</sup> CFU/larva in the case of *B. cenocepacia* (Seed and Dennis, 2008). The virulence of *Burkholderia* spp. is the results of several factors, including potent

## 2.4. DISCUSSION

---

biofilm formation, intrinsic antibiotic resistance, great metabolic and genetic plasticity, multiple secretion systems, and the ability to persist intracellularly within macrophages and other eukaryotic cells (Loutet and Valvano, 2010). To fully elucidate the lethality of *C. pauculus* MF1 infection, further investigation in these areas would be needed, as there are no other published reports available of use of the *G. mellonella* model with *C. pauculus*. Turning to biofilm results, *C. pauculus* MF1 biofilm was evident from 24 h and increased over 72 h at both physiological and environmental temperatures in minimal and rich conditions. The determination of biofilm formation was conducted using the crystal violet solubilisation assay, which while being a widely used and well-established assay, is limited in that it quantifies total microbial biomass and cannot enumerate bacteria or quantify their viability. Prior to the Butler et al. (2022) article, there was little published information regarding *C. pauculus* biofilm. The antibiofilm efficacy of disinfectants against biofilms containing *C. pauculus* from the International Space System was investigated by one study, finding an 18 h flush with either 6% H<sub>2</sub>O<sub>2</sub> or a mixture of 3% H<sub>2</sub>O<sub>2</sub> and 400 parts per billion colloidal silver reduced preformed biofilms to <1 CFU mL<sup>-1</sup> (Wong et al., 2010). An interesting side note in that study was concerning the control biofilm, where *C. pauculus* predominated at an 8:2 ratio with *Burkholderia multivorans*, despite initial equal seeding with those and two other isolates. The ability of *C. pauculus* to persist and dominate biofilm in these nutrient-poor conditions reinforces concerns that it may successfully persist in hospital WPS, however surveillance and microbiological characterisation data are not readily available for this emerging pathogen. Further work would need to be conducted to investigate the virulence of *C. pauculus* MF1, to determine whether its virulence is truly reduced in all relevant conditions, for example in eukaryotic cell infection. To further determine the risk that *C. pauculus* poses in hospital WPS, a labora-

tory model system could be used to simulate colonisation of a hospital sink trap and pipework. Previous work using a model system has found that *Escherichia coli* and *Enterobacter cloacae* migrate through wastewater pipework and establish themselves in hospital sink traps (Aranega-Bou et al., 2021).

## 2.5 Conclusion

In this chapter, culture-dependent and -independent means of investigating the bacteria within hospital sink traps are presented. Both methods indicated the presence of many bacteria which have previously been reported as having been isolated from hospital sink traps in the literature (Table 2.1), suggesting that the methods were sound and provided consistent results. The 16S rDNA sequencing surveys completed, using both MinION and Illumina platforms, revealed a great deal more diversity in sink traps than was indicated by culture, which is also consistent with the published literature regarding the hidden microbial diversity that can be revealed by molecular approaches. However, while the concept of molecular approaches revealing greater microbial diversity is established in the microbiological literature, there are very little published data available regarding the 16S 'metagenome' of hospital sink traps or WPS. Turning to the bacteria identified in particular, the majority were Gram-negative and already implicated in nosocomial infections (*P. aeruginosa*, *A. baumannii*, *S. marcescens*) and members of the family *Enterobacteriaceae* (*K. pneumoniae*, *Escherichia coli*, *Enterobacter cloacae*, *Citrobacter freundii*). An emerging human pathogen was identified, namely *Cupriavidus pauculus*, which had not previously been isolated from a hospital sink trap and which showed multidrug resistance and potent biofilm formation potential compared to *P. aeruginosa* in an *in vitro* system. The appearance of a multidrug-resistant and biofilm-

## 2.5. CONCLUSION

---

forming strain of *C. pauculus* in a known pathogen reservoir within a clinical setting was concerning, even if experiments with *G. mellonella* indicated relatively low virulence. Further general surveys of hospital WPS are needed, particularly using molecular methods such as 16S rDNA amplicon sequencing, to characterise the commonly prevalent bacteria in these environments. This work will help to determine the overall prevalence of *Cupriavidus* spp. as well as other pathogens and potentially emerging pathogens. Increased identification and appreciation of the presence of emerging pathogens such as *C. pauculus* may lead to more targeted surveillance in hospital settings, which could include more routine targeting of *C. pauculus* and other similar emerging pathogens with associated characterisation to identify acquisition of, for example, antibiotic resistance genes or altered phenotypic behaviour leading to greater persistence or virulence. A further avenue of research would be a more targeted investigation of the potential pathogenic nature of *C. pauculus* in eukaryotic cells. For example, *in vitro* infection experiments with immune cells such as macrophages would help elucidate the immune response to *C. pauculus* and whether infection can be sufficiently controlled by normal immunity.

Together, these findings underscore the large diversity of bacterial pathogens present in hospital sink traps and the need for novel strategies to control their persistence and dissemination.

## 2.5. CONCLUSION

---

## Chapter 3

# Nanocoating development and characterisation

### 3.1 Introduction

As described in Section 1.5.3 on page 56, nanocoatings represent an efficient way to apply silver nanoparticles as antimicrobials. By exhibiting early toxicity to bacteria and inhibition of biofilm formation, silver nanocoatings can prevent bacterial colonisation of surfaces (Agnihotri et al., 2013; Besinis, De Peralta and Handy, 2014a; Besinis et al., 2017; Petrochenko et al., 2017). In this chapter, the development and material characterisation of a pipe cement-based silver nanocoating on uPVC are described. In later chapters, the antibacterial efficacy of the developed silver nanocoating is investigated in different settings.

The material properties of surfaces affect bacterial adhesion and biofilm formation. Among the properties of any surface, its nanoscale shape and roughness profile (here termed 'nanotopography') have the most significant potential to modulate interactions with bacteria (Crawford et al., 2012). The adhesion of microorganisms to substrates can be explained by the classical Derjaguin-Landau-Verwey-Overbeek (DLVO) theory of colloid stability. Generally, the DLVO theory describes the net interaction between a cell and substrate as a balance



### 3.1. INTRODUCTION

between van der Waals interactions, which are generally attractive, and repulsive interactions due to the negative charge of cells and substrates (Hermanson, 1999). Figure 3.1 summarises the extended DLVO theory as it applies to bacterial attraction to a substrate, although it should be borne in mind that bacterial adhesion is unlikely to ever be fully captured by a single theory (Bos et al., 1999).

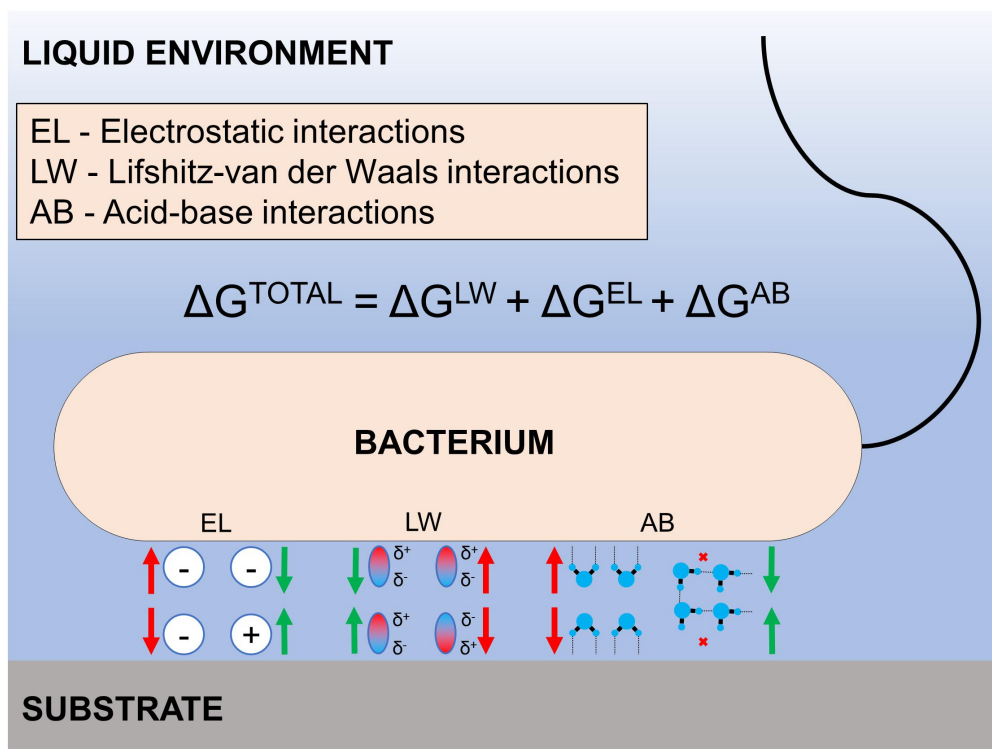

Figure 3.1: Illustration of the extended DLVO theory as it applies to the attraction of bacteria to a substrate.  $\Delta G$  refers to change in Gibbs free energy. Figure adapted from Figure 2 of Zheng et al. (2021).

Generally, bacteria are considered more likely to adhere to substrates with greater surface roughness due to their associated greater specific surface area as well as the defects in the surface (e.g. pits, bumps or troughs) which provide protection from shear forces or contact abrasion with other surfaces (Crawford et al., 2012). An exception to this generalisation could be the use of rel-

### 3.1. INTRODUCTION

---

actively rough surface paints on ships which resist biofouling by self-polishing when the ship is in motion due to the creation of turbulent water flows (Lewis, 1998; Howell and Behrends, 2006). It therefore follows that most surfaces intended to have antibiofilm effects should be designed to be 'smooth', to reduce bacterial adhesion and biofilm formation. However, comparisons of surfaces have shown that bacteria are significantly more sensitive to microscale and nanoscale surface roughness than previously believed (Mitik-Dineva et al., 2008), and so many apparently smooth surfaces may potentially not be smooth enough (Scheeren Brum et al., 2021). Previous estimations of what constitutes a 'smooth' surface, from the point of view of bacteria, have failed to take into account the appendages potentially present on bacterial cells, such as flagella, which are able to aid in surface attachment by anchoring to surface defects much smaller than the bacteria themselves, *i.e.* potentially at the nanoscale (Friedlander et al., 2013; Mi et al., 2018). Along with flagella, bacteria assemble a range of adhesive proteins (adhesins) which may be in the form of monomeric proteins or polymeric 'hairlike' fibres that extend outwards from the cell surface such as fimbriae/pili (Duguid et al., 1955; Brinton, 1959; Ottow, 1975; Chahales and Thanassi, 2015). Through the expression and assembly of these structures, bacteria are able to perform 'mechanosensing' to detect and explore surfaces prior to attachment or biofilm formation (Gordon and Wang, 2019; Chawla et al., 2020; Mordue et al., 2021). Work to develop anti-adhesive surfaces has actually found that nanorough surfaces (with nanoroughness of 6 nm and lowest surface peak density of 2 nm) reduced *E. coli* and *S. aureus* adhesion by 55.6% and 40.5%, respectively (Lüdecke et al., 2016). A similar finding has been reported for nanosmooth versus nanorough titanium regarding adhesion by *S. aureus*, *Staphylococcus epidermidis* and *P. aeruginosa* (Puckett et al., 2010). Overall, it is likely that rough versus smooth is an oversimplifica-

### 3.1. INTRODUCTION

---

tion, although still a relevant characteristic to quantify, and the overall adhesive or anti-adhesive nature of a surface will be a more complex interplay of surface topography and structure.

Other surface-related factors such as surface free energy, wettability/hydrophobicity and surface chemistry, as well as phenotypic differences between bacteria, may also affect the likelihood of successful bacterial adhesion (Zheng et al., 2021).

Despite this multitude of different competing factors, it is helpful and relatively straightforward to quantify surface roughness as an indicator of the nature of the surface nanotopography. Surface roughness can be quantified in different ways: the two metrics used here are  $R_a$ , which describes the mean deviation of the roughness profile, and  $R_z$ , which describes the maximum primary height of the roughness profile (*i.e.* the peak to valley height). These concepts are illustrated in Figure 3.2. The use of confocal microscopy to quantify  $R_a$  and  $R_z$  can also be accompanied with the generation of three-dimensional images which provide a qualitative visualisation of surfaces.

### 3.1. INTRODUCTION

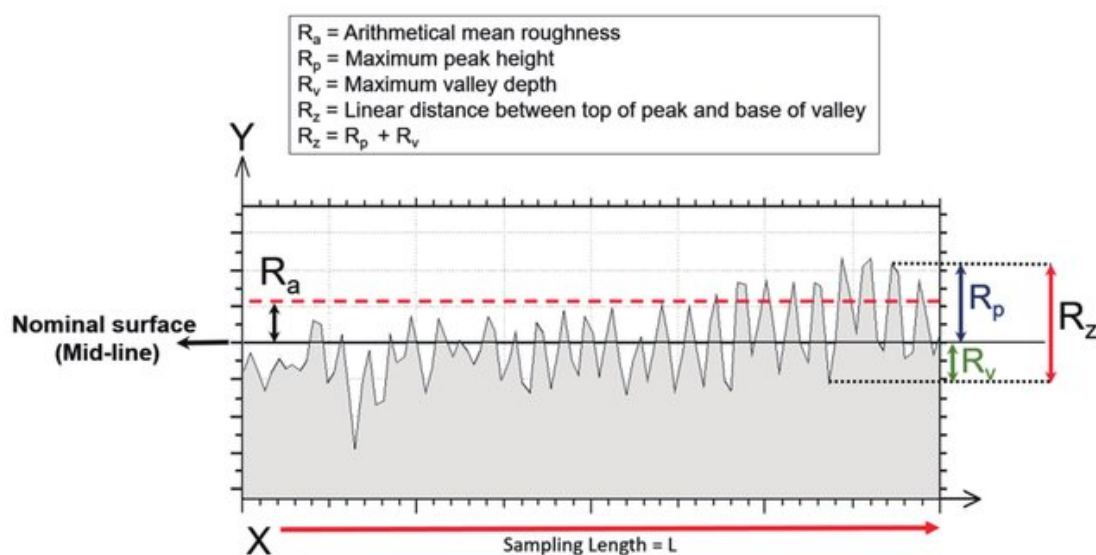

Figure 3.2: Illustration of the surface roughness parameters  $R_a$  and  $R_z$ . Figure taken from Tekçe et al. (2018).

The stability of nanocoatings must also be considered, as rapid release of, for example silver nanoparticles, from the coating may lead to loss of effects over time due to depletion of the store of nanoparticles and potential ecotoxicological implications on the environment (Lead et al., 2018; Salaie et al., 2020). The dissolution of silver from the nanocoating, if it is to occur at all, must be slow enough to avoid these problems, but release of nanoparticles and dissolution of silver is needed if the nanocoating is to have a local antibacterial effect (Wang et al., 2017). Engineered nanomaterials are generally regarded as being 'sparingly soluble' and form dispersions in water, but metal-containing nanomaterials can release metal ions from the surface by dissolution (Handy et al., 1989). The dialysis assay, as described by Handy et al. (1989), quantifies the release of silver by dissolution into ultrapure water surrounding the coated discs. In the dialysis assay, silver that has not dissolved but has been released from the nanocoating will be present in the dialysis bag, as the pore size of the dialysis membrane being  $<2.5$  nm will only allow diffusion of solutes and not

intact nanomaterials. The time points and medium used can be varied depending on the aims, providing a controlled experiment which quantifies the stability of the nanocoating under different conditions (Handy et al., 1989).

#### 3.1.1 Aims

The aims of the work described in this chapter were to develop a silver nanocoating and successfully apply it to the surface of a suitable plumbing polymer material, followed by appropriate material characterisation of the resulting silver nanocoating using an array of analytical techniques to investigate its surface roughness, nanotopography, availability of surface silver, and stability.

#### 3.1.2 Objectives

To achieve the above aims, the following objectives were set:

- Develop a silver nanocoating by adding silver nanoparticles to a suitable matrix and a 'no particle control' coating for comparison.
- Measure the surface roughness of uPVC and nanocoatings and visualise the three-dimensional surface nanotopography.
- Confirm the presence of silver on the surfaces of nanocoatings using Raman spectroscopy.
- Investigate the stability of the silver nanocoatings by measuring silver dissolution over time.

## 3.2 Materials and methods

### 3.2.1 Substrate material selection

The selection of substrate material was primarily based on data available describing the prevalence of different polymers in hospital WPS (*e.g.* Department of Health (2016)). Candidate materials included polyvinyl chloride (PVC), polypropylene, and acrylonitrile butadiene styrene. Unplasticised polyvinyl chloride (uPVC) has been reported to be the most prevalent polymer used in European plumbing systems (Martins et al., 2009), and therefore was chosen as the appropriate substrate for this project.

### 3.2.2 Specimen preparation

A 1 mm thickness sheet of uPVC was purchased from Pure Plastics Ltd. (Bristol, UK) and discs of 15 mm diameter cut by Waterjet Profiles Ltd. (Plymouth, UK). The disc design included two notches cut out on opposing edges to facilitate handling with fine tweezers without scratching their surface. A computer-aided design (CAD) file was produced (Figure 3.3) using SolidWorks (Dassault Systèmes SolidWorks Corporation, MA, USA) to allow precision manufacturing of the discs. The disc diameter was carefully selected to allow discs to fit in a 24-well plate and occupy the maximum possible surface area at the bottom of wells. The notches were also designed to be large enough to allow physical manipulation with tweezers without being so large as to unnecessarily reduce the disc surface area. Following cutting from the uPVC sheet, discs required some post-processing to remove a thin protective plastic film, deburring of their outer edge, and removal by scalpel of a small tag left to attach each disc to the sheet.

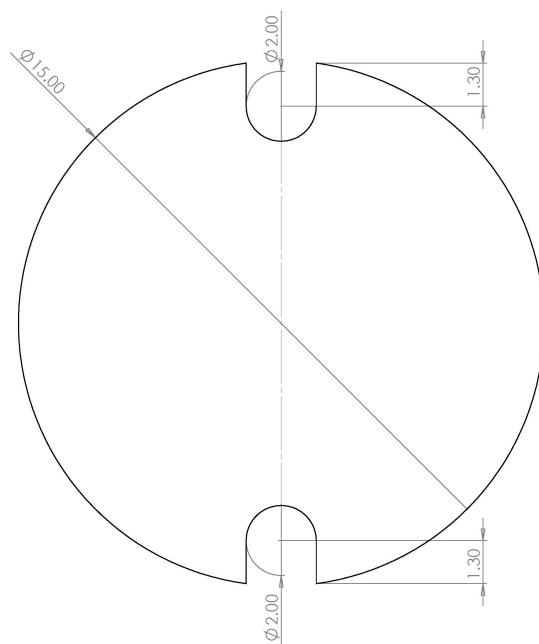

Figure 3.3: Engineering drawing showing design of uPVC disc to be cut from sheet by water jet. The design includes notches on opposing edges to facilitate easy manipulation with tweezers. The  $\varnothing$  symbol refers to diameter measurements. All values are in millimetres.

### 3.2.3 Preparation and application of nanocoatings

The preparation of silver nanosolutions was conducted based on previously published methods (Federici et al., 2007; Besinis, De Peralta and Handy, 2014a,b; Meran et al., 2018). Silver nanopowder with particle size  $<100$  nm (Sigma-Aldrich, UK) was mixed with acetone to give a silver concentration of  $20 \text{ g L}^{-1}$ , *i.e.* two times the final intended silver concentration. This mixture was vortexed for 30 s and sonicated (35 kHz, Fisherbrand FB 11010, Germany) in a glass vial in the dark for 4 h to break up silver agglomerates and to ensure a low mean particle size (Besinis, De Peralta and Handy, 2014b). The silver-acetone mixture was then mixed in a 1:1 ratio by mass with pipe cement (PC) (PVC Solvent Cement, Aquaflow, UK), giving a final silver concentration of  $10 \text{ g L}^{-1}$ , and vortexed once again for 30 s. This mixture produced the nanocoating termed

### 3.2. MATERIALS AND METHODS

---

'Ag-PC'. The addition of acetone was to reduce the viscosity of the mixture, enabling more effective mixing of silver nanoparticles and easier application to discs. Acetone was deemed to be an appropriate addition due to the PC already containing a large proportion of acetone and ethyl methyl ketone (see Appendix B for PC composition). A no particle control of pipe cement lacking silver nanoparticles, producing a coating termed 'PC', was prepared by mixing acetone with pipe cement in the same ratio as in the Ag-PC group and was necessary to check for properties and toxicity of the PC itself. Discs were coated by applying 100  $\mu$ L of the respective mixtures to each face of the discs using a pipette with wide bore pipette tips and leaving to dry for 10 min between coating application to each face. Both faces of the discs previously coated with Ag-PC (hereafter also referred to as the 'silver nanocoating') or PC alone were briefly ground on a Buehler EcoMet 250 grinder-polisher with FEPA 800 silicon carbide paper (22  $\mu$ m grain size, Struers, Denmark) and surface finish assessed visually. Grinding was conducted on Ag-PC and PC discs but not uncoated uPVC discs because the rationale for grinding the surface of the silver nanocoatings was to expose nanoparticles that may have settled away from the surface of the pipe cement-acetone mixture during application. Finally, discs were sterilised by immersion in a 2% sodium hypochlorite (NaOCl) solution in sterile 50 mL centrifuge tubes, placed on a roller mixer at RT for 15 min, before decanting the NaOCl solution and triple rinsing with sterile deionised water to remove hypochlorite residue.



The resulting experimental groups were:

- Uncoated uPVC discs as a no coating control ('uPVC').
- Pipe cement-coated discs as a no particle control ('PC').
- Silver pipe cement-coated discs as the treatment group ('Ag-PC') without grinding.
- Silver pipe cement-coated discs as the treatment group ('Ag-PC') with grinding.

#### 3.2.4 Surface roughness

Surface roughness was quantified by measuring the mean deviation of the roughness profile ( $R_a$ ) and the maximum primary height of roughness profile ( $R_z$ ) using an Olympus LEXT OLS 3000 confocal laser scanning microscope equipped with a 408 nm laser diode class 2 laser. Measurements were conducted using an optical zoom of 1x and a total magnification of 50x. Profiles were Gaussian filtered with a cut-off wavelength value of 85.2  $\mu\text{m}$ . Surface roughness was measured at three different locations on the surface of each disc ( $n=6$  discs/group). Surface nanotopography was further investigated by 3D analysis using the Olympus LEXT OLS 6.0.7 software.

#### 3.2.5 Raman spectroscopy

Raman spectra were measured using a Horiba XploRA<sup>TM</sup> system (Horiba, Japan) with a 532 nm laser. A grating with a 1200  $\text{g mm}^{-1}$  groove density was chosen in order to reach a spectral resolution of roughly 2.8  $\text{cm}^{-1}$  between 1000–3000  $\text{cm}^{-1}$ . For each measurement, 25 individual Raman spectra were

captured in a 5 x 5 grid to make a representative summary plot. All Raman spectra were captured in the ambient laboratory environment, within a class 100 clean room, with a laser power of 4 mW. Representative peaks for silver nanoparticles and uPVC were identified by reference to the relevant published literature (Kora and Jayaraman, 2012; Prokhorov et al., 2016; Joshi et al., 2018).

#### **3.2.6 Nanocoating stability determination by dialysis assay**

The stability of the silver nanocoatings was assessed by measuring the total concentration of silver in ultrapure water over a 24 h period. This was achieved by running a dialysis assay according to the experimental protocols published by Handy et al. (1989) and Besinis, De Peralta and Handy (2014*b*). Prior to the experiment, all glassware, stirrer bars, and dialysis tubing were acid washed in a 5% nitric acid bath overnight and then triple rinsed in ultrapure water (Milli-Q; 18.2 M $\Omega$ , Elga, France). Dialysis tubing with a molecular weight cut-off of 12 kDa and an approximate exclusion size of 2.5 nm (Sigma-Aldrich, MO, USA) was used to make 70 mm x 25 mm dialysis bags filled with 8 mL Milli-Q water. Discs were placed in separate dialysis bags which were then sealed with clips and suspended from retort stands such that they were immersed in identical beakers containing 492 mL Milli-Q water. Care was taken to select beakers of identical size and shape, and each group was tested in triplicate. The solutions in the beakers were gently agitated with a multipoint magnetic stirrer for 24 h at room temperature. Samples (4.5 mL) of the external media were taken from each beaker at 0, 0.5, 1, 2, 3, 4, 6, 8, and 24 h. Samples were immediately acidified by addition of 100  $\mu$ L 68% (*v/v*) nitric acid (AnalaR NORMAPUR<sup>®</sup> analytical reagent, VWR, PA, USA), vortexed, and stored in sterile plastic tubes

### 3.2. MATERIALS AND METHODS

---

at 4 °C in the dark. At the end of the experiment, the remaining contents of the dialysis bags were also collected, acidified, and stored as above. All samples were analysed within 24 h by inductively coupled plasma mass spectrometry (ICP-MS) to quantify total silver. Acidified matrix-matched standards were prepared from a multielement standard solution (LabKings, Netherlands) to cover the expected range of silver in the samples. The chosen standard range was 0.1–10 µg L<sup>-1</sup>. The ICP-MS instrument (XSeries, Thermo Scientific, UK) was calibrated and checked for conformity to the manufacturer's specifications on a daily basis by technical staff. Work was conducted under the ISO 9001 certification held by the facility. Analyses were conducted on <sup>107</sup>Ag. Quality control measures of procedural blanks (*n*=3) and standard checks every 10–15 samples were included.

### 3.3 Results

#### 3.3.1 Surface roughness

The surface roughness values indicated by the metrics  $R_a$  and  $R_z$  of uncoated and coated specimens, including a comparison of ground and unground surfaces, are shown in Figure 3.4.

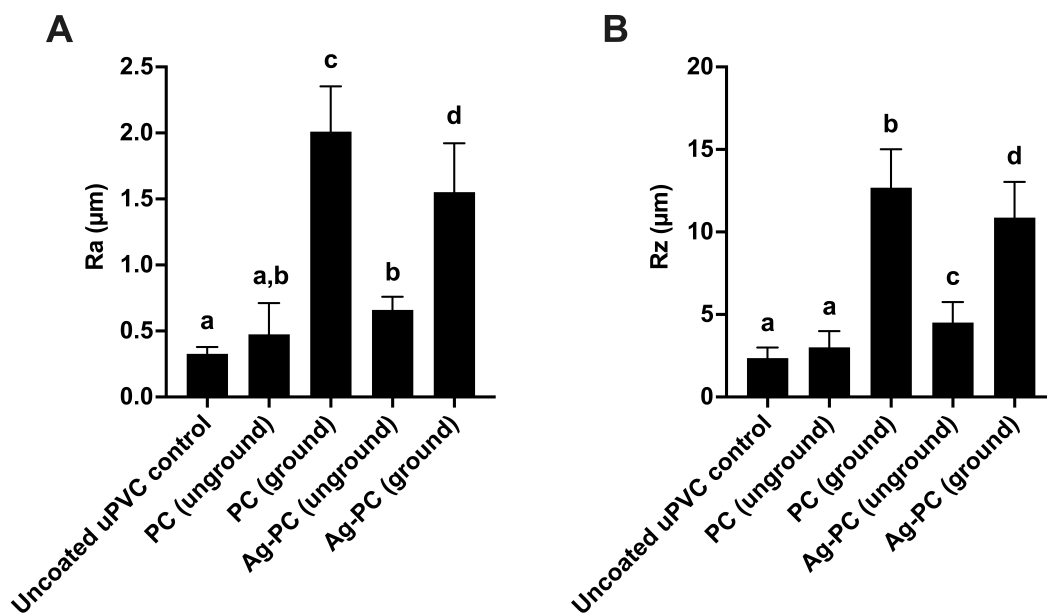

Figure 3.4: Surface roughness of nanocoatings with different finishes, expressed as  $R_a$  (A) and  $R_z$  (B) values. uPVC, unplasticised polyvinyl chloride; PC, pipe cement coating (no particle control); Ag-PC, silver-pipe cement coating. Measurements were taken at three different locations across the surface of each disc, with  $n=6$  discs/group. The terms ‘ground’ versus ‘unground’ relate to the inclusion or exclusion of a grinding step using FEPA 800 silicon carbide paper. All data are expressed as mean  $\pm$  standard deviation. Letters above bars denote significant differences such that bars which share a letter are not significantly different from each other ( $p > 0.05$ ); one-way ANOVA with Tukey’s multiple comparisons test.

The roughest surfaces, by both metrics, were those which had been ground; the ground PC surface was significantly rougher than the ground Ag-PC surface

### 3.3. RESULTS

---

( $p < 0.0001$  for  $R_a$  and  $p = 0.0223$  for  $R_z$ ).  $R_a$  values showed that unground Ag-PC was not significantly rougher than unground PC ( $p = 0.2373$ ). However  $R_z$  values did indicate a significant difference ( $p = 0.0374$ ). The PC surface without grinding did not show a significant difference in surface roughness compared to uncoated uPVC for either metric ( $p = 0.5216$  for  $R_a$  and  $p = 0.7549$  for  $R_z$ ). All other surface finishes showed a significant increase in surface roughness compared to the uncoated uPVC control ( $p < 0.0001$ ). The surface roughness values for the ground Ag-PC coating, which was taken forward as the silver nanocoating for bioassays described in subsequent chapters, were  $1.55 \mu\text{m}$  ( $\text{SD} \pm 0.37 \mu\text{m}$ ) for  $R_a$  and  $10.87 \mu\text{m}$  ( $\text{SD} \pm 2.17 \mu\text{m}$ ) for  $R_z$ .

#### 3.3.2 Surface nanotopography

Following surface roughness measurements, representative images were acquired to illustrate the surface nanotopography of specimens (Figure 3.5). Examining these representative three-dimensional images visually, it was confirmed that uncoated uPVC was relatively smooth and flat (Figure 3.5A). The application of the PC coating, with or without silver nanoparticles, produced a rougher surface (Figure 3.5B–D). The process of grinding introduced significant additional grooves leading to more pronounced surface roughness (Figure 3.5D).

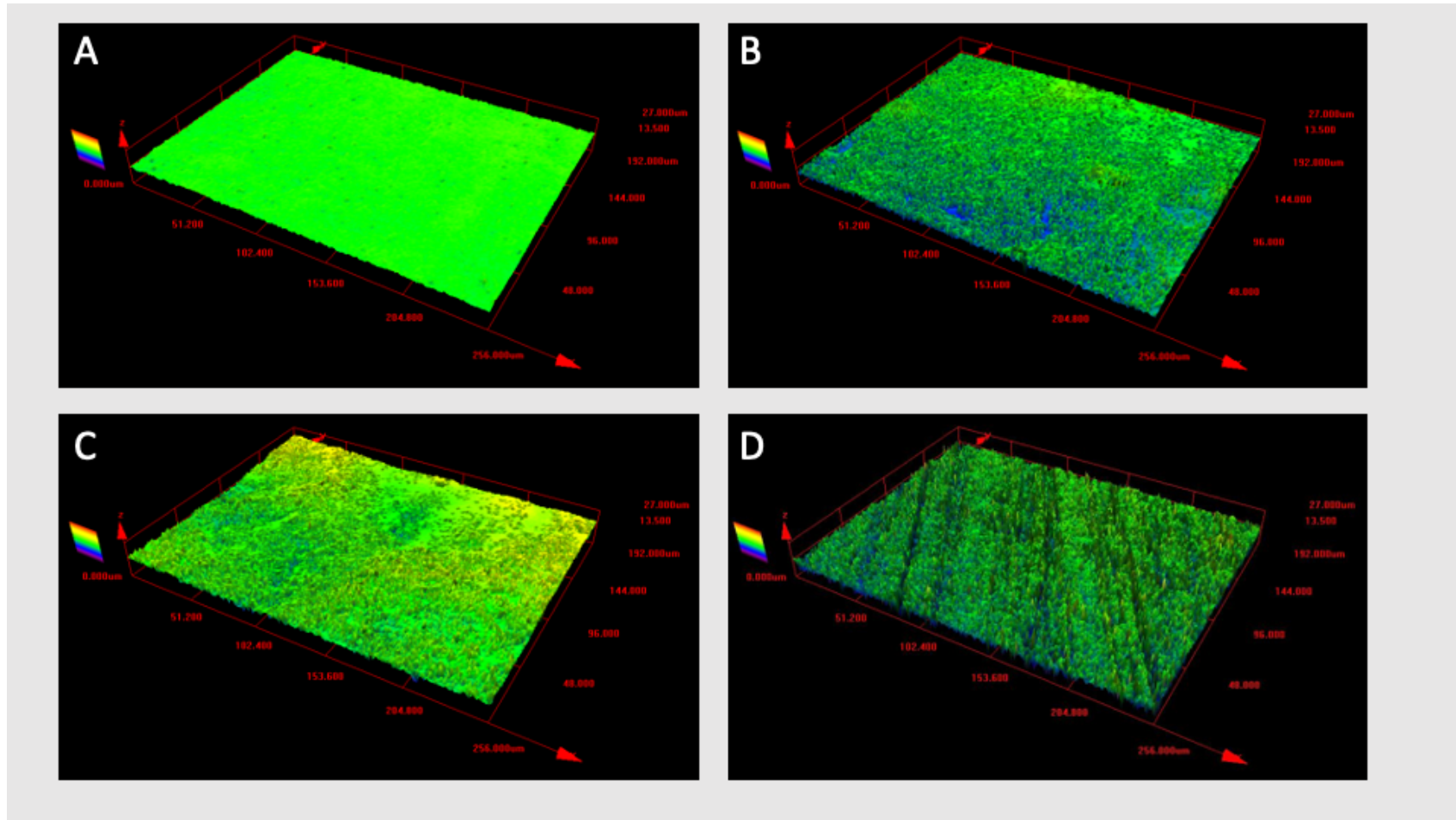

*Figure 3.5:* Representative three-dimensional images showing the surface nanotopography of uncoated uPVC discs (A), uPVC discs coated with pipe cement alone (B), uPVC discs coated with pipe cement and silver nanoparticles without a grinding step (C), and uPVC discs coated with pipe cement and silver nanoparticles followed by a grinding step with FEPA 800 silicon carbide paper (D). Images were acquired by an Olympus LEXT OLS 3000 confocal laser scanning microscope equipped with a 408 nm laser diode class 2 laser at the time of surface roughness measurements. Total magnification x50. In each image, the limit of the x-axis is 256 µm, the y-axis is 192 µm, and the z-axis is 27 µm.

#### 3.3.3 Raman spectroscopy

Raman spectra between wavelengths of 1000–3000  $\text{cm}^{-1}$  were produced. Figure 3.6 shows average plots of Raman spectra ( $n=3$ ). Figure 3.6A, measuring the spectra from uPVC alone, shows double peaks in the range of wavenumbers 600–700  $\text{cm}^{-1}$ . Figure 3.6B–C, spectra of unground Ag-PC discs and ground Ag-PC discs respectively, have similar peaks to each other at around 1550–1600  $\text{cm}^{-1}$ . The peaks in Figure 3.6A likely correspond to uPVC, and those in Figures 3.6B and 3.6C to silver nanoparticles, as discussed in Section 3.4.2 on page 130.

#### 3.3.4 Nanocoating stability

The dialysis assay was conducted to measure the extent of silver dissolution from the coatings in ultrapure (Milli-Q) water, and thereby determine the stability of the nanocoating in those conditions. The release of total silver from the nanocoating over the 24 h period was very low, not discernible from the uPVC and PC groups which acted as no-particle controls for this experiment. These findings suggested negligible dissolution (Figure 3.7). The final (24 h) mean measurements for the Ag-PC (unground) and Ag-PC (ground) groups were 0.186  $\mu\text{g L}^{-1}$  ( $\text{SD}\pm 0.059 \mu\text{g L}^{-1}$ ) and 0.159  $\mu\text{g L}^{-1}$  ( $\text{SD}\pm 0.060 \mu\text{g L}^{-1}$ ), respectively. The theoretical maximum possible value, if all silver from coated discs completely dissolved during the experiment, would be 4000  $\mu\text{g L}^{-1}$ . Based on this theoretical maximum, the percentage final silver dissolution in Milli-Q water after 24 h can be calculated as 0.005 % and 0.004 % for the Ag-PC (unground) and Ag-PC (ground) coatings, respectively.

### 3.3. RESULTS

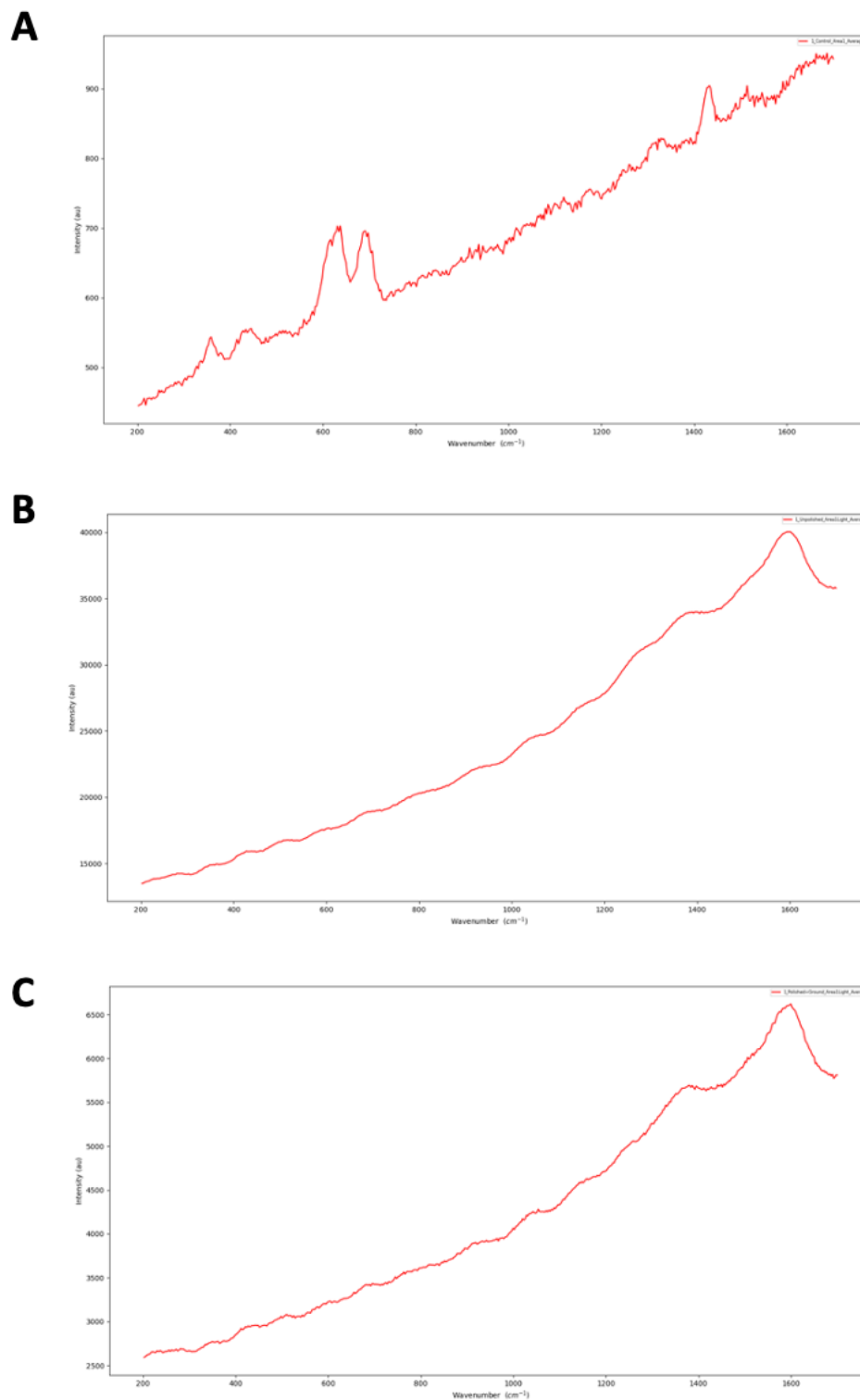

*Figure 3.6:* Averaged Raman spectra plots showing measurements of uPVC discs (A), unground Ag-PC discs (B), and ground Ag-PC discs (C). The x-axis indicates wavenumber (200–1600 cm<sup>-1</sup>) and the y-axis indicates intensity in arbitrary units (au). Note: the intensity ranges shown are not uniform.



### 3.3. RESULTS

Samples of the contents of each dialysis bag were also taken at the 24 h endpoint. The resulting silver concentrations in the dialysis bags were  $3.343 \mu\text{g L}^{-1}$  ( $\text{SD} \pm 2.452 \mu\text{g L}^{-1}$ ),  $7.941 \mu\text{g L}^{-1}$  ( $\text{SD} \pm 5.518 \mu\text{g L}^{-1}$ ),  $2.208 \mu\text{g L}^{-1}$  ( $\text{SD} \pm 1.422 \mu\text{g L}^{-1}$ ) and  $2.983 \mu\text{g L}^{-1}$  ( $\text{SD} \pm 2.188 \mu\text{g L}^{-1}$ ) for the uPVC, PC, Ag-PC (unground) and Ag-PC (ground) groups, respectively. The highest value here corresponds to a total silver release of 0.2%. In practice, these values are negligible and no significant trends or differences can be described as the values of experimental groups do not differ from controls.

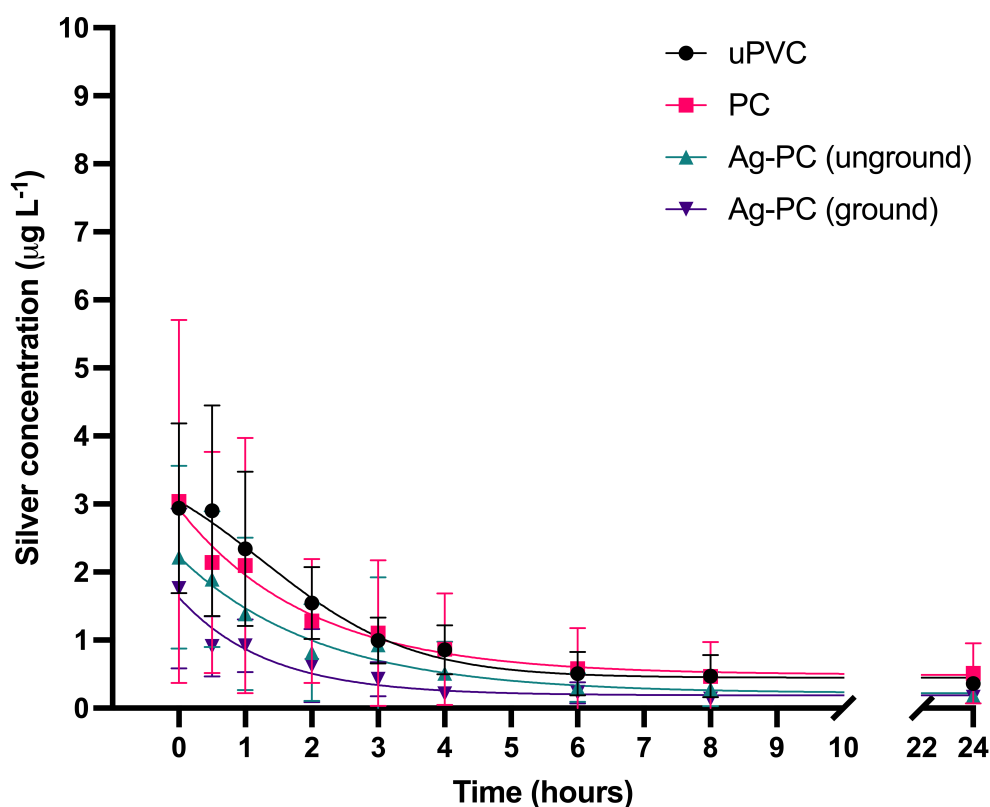

Figure 3.7: Dialysis assay of different nanocoatings showing release of silver in ultrapure (Milli-Q) water over 24 h as determined by inductively coupled plasma mass spectrometry. The terms 'ground' versus 'unground' relate to the inclusion or exclusion of a grinding step using FEPA 800 silicon carbide paper. All data are expressed as mean  $\pm$  standard deviation.

Note that the  $y$ -axis of Figure 3.7 is in units of  $\mu\text{g L}^{-1}$ , which are equivalent to parts per billion. The limit of detection (LOD) of ICP-MS is theoretically extremely low, potentially extending down to  $\text{pg L}^{-1}$  values, or parts per trillion (Chemnitzer, 2019), however, the standards used must be taken into account. For this assay, the ICP-MS standard range for silver was  $0.1\text{--}10\ \mu\text{g L}^{-1}$ .

## 3.4 Discussion

### 3.4.1 Surface roughness and nanotopography

Confocal laser scanning microscopy showed that the application of the pipe cement coating alone did not significantly increase the surface roughness of discs, however, the application of a silver pipe cement coating did (Figure 3.4). The grinding process significantly increased surface roughness, although the roughest surfaces, by both  $R_a$  and  $R_z$  metrics, were the pipe cement-coated surfaces which had been ground. The surface roughness of the nanocoating described here was not intentionally designed, rather the data are presented for the sake of characterisation. Surface roughness results were similar between the two metrics used ( $R_a$  and  $R_z$ ), with both giving similar patterns of differences between groups. The only difference was in the Ag-PC (unground) group: the  $R_a$  metric indicated no significant difference from the PC (unground) group, whereas the  $R_z$  metric did indicate a significant difference.

Considering the images in Figure 3.5C versus 3.5D, the grooves introduced by the grinding process are evident and appear to be the approximate depth of the grain size ( $22\ \mu\text{m}$ ) of the FEPA 800 silicone carbide paper used, further indicating that the grooves were indeed introduced by the grinding process. A potential future avenue of work could involve investigating whether the grinding

step could be followed by a polishing step to give a smoother finish, as this may have the potential to increase the innate antibiofilm effect of the nanocoating (Uneputty et al., 2022). This step would be a refinement of the method, but ultimately does not appear to be crucial from a biological standpoint as the Ag-PC (ground) coating has significant antibiofilm activity despite its relatively rough surface (see Chapter 4 starting on page 135).

#### 3.4.2 Characterisation of the nanocoating surface

The peaks on the Raman spectra for silver-coated discs at 1550–1600  $\text{cm}^{-1}$  are in accordance with those for silver nanoparticles published by Kora and Jayaraman (2012) and Joshi et al. (2018). The double peaks at 600–700  $\text{cm}^{-1}$  for the uPVC (uncoated) group (Figure 3.6A) were not present in measurements of coated discs. Previous published findings indicate that PVC structures give Raman peaks in the region of 613–696  $\text{cm}^{-1}$  (Prokhorov et al., 2016), suggesting that the double peaks were most likely due to uPVC. With a laser wavelength of 532 nm, the depth resolution of Raman spectroscopy can be up to approximately 0.7  $\mu\text{m}$  (Xu et al., 2018), so this technique will only give spectra for materials on the immediate surface of the discs. As the pipe cement-based silver nanocoating is clearly much thicker than this maximum depth resolution value, it is not surprising that there is no signal for uPVC on the coated discs.

The use of this method confirmed the presence of silver nanoparticles on the surface of Ag-PC coated discs, both ground and unground, and confirmed that silver was not present on the uncoated uPVC discs with a signal for uPVC being detected instead. While grinding is expected to have exposed more silver on the surface of Ag-PC discs by revealing nanoparticles which had sunk into the liquid coating during drying, it is not possible to quantify and compare the

silver signal between measurements due to differences in laser intensity and focus of the surface. The use of Raman spectroscopy here is therefore limited to giving representative peaks of the materials present.

#### 3.4.3 Stability of silver within the nanocoating

The silver release from the silver nanocoatings, both ground and unground, over 24 h under controlled dialysis assay conditions (room temperature, 500 mL total volume of Milli-Q water, sterile) remained negligible, with an approximate value of 0.004–0.005 % (for calculation see Section 3.3.4 on page 126). Besinis et al. (2017) reported silver loss of <0.07 % from silver nanocoatings on titanium alloy and Meran et al. (2018) reported silver loss below the ICP-OES detection limit from silver nanocoatings on maxillofacial prostheses, while Stebounova et al. (2011) showed <0.1 % dissolution of nanosilver in simulated biological fluids over 24 h.

The low dissolution of ionic silver from nanocoatings incorporating silver nanoparticles is one of the reasons why they are being explored and developed for use as alternative antimicrobial strategies (Besinis, De Peralta and Handy, 2014a; Besinis et al., 2017; Meran et al., 2018). Low dissolution means that they are highly stable and also maintain their integrity, making them suitable for *in vivo* use on medical implants and maxillofacial prostheses. Low levels of silver release result in low exposure of the surrounding tissues, and therefore potentially low levels of resulting inflammation and toxicity (Stebounova et al., 2011; Meran et al., 2018). For the environmental application of the pipe cement-based silver nanocoating described here, low levels of silver release are desirable to alleviate concerns over ecotoxicity due to excessive release of silver into the WPS and environment beyond (Lead et al., 2018; Salaie et al., 2020). Silver is con-

### 3.4. DISCUSSION

---

sidered toxic in the aquatic environment with reports of silver concentrations in the low  $\text{ng L}^{-1}$  conferring potential risks to invertebrates and fish (Fabrega et al., 2011). However, a protective threshold value for dissolved silver towards freshwater organisms has been proposed at  $0.116 \mu\text{g L}^{-1}$  (Arijs et al., 2021). Stability also suggests potential longevity of the nanocoating's activity as the 'store' of silver will not be rapidly depleted. If a purely linear release of silver is considered, taking a 0.004–0.005 % release over 24 h period as a guide, the store of silver in the nanocoating could theoretically take as long as 68 years to be fully depleted. These results are limited by the relatively artificial nature of the dialysis assay which, while providing stable and reproducible conditions for modelling of silver dissolution, does not necessarily accurately reproduce the conditions used for *in vitro* experiments in Chapter 4 (e.g. temperature of  $37^\circ\text{C}$ , bacteriological growth media rather than deionised water and inclusion of bacteria). Furthermore, sink traps undergo prolonged periods of stagnation between use and are not subject to continuous stirring as was performed in the dialysis assay. This very low dissolution of silver suggests high stability of silver nanoparticles within the pipe cement matrix, however this could impact antibacterial performance if silver release is too low to have an effect. In such cases, other methods of silver deposition would need to be considered beyond use of cement as a matrix, perhaps to deposit silver nanoparticles directly on the uPVC surface where the lack of a matrix would lead to greater silver release over time. Alternatively, a degrading matrix could be considered; where the matrix itself breaks down under certain conditions, such as being immersed in liquid, to steadily release silver. To further investigate the stability of the silver nanocoating developed here, silver release is also quantified in Chapter 4 during antibacterial assays to ascertain how the silver release profile may differ in those conditions.

### 3.5 Conclusion

In this chapter, the development of a pipe cement-based silver nanocoating for application to uPVC surfaces is described. This nanocoating is then characterised from a materials engineering standpoint, specifically investigating its surface roughness and nanotopography, the presence of silver on the surface, and the stability of silver in the nanocoating under liquid conditions. Surface roughness was found to be increased by all coatings, but was increased further by grinding the coating with troughs clearly present on the surfaces when visualised by confocal microscopy. Silver was confirmed to be present on the silver nanocoated surfaces by Raman spectroscopy, and no silver signal was present on the uPVC surfaces but peaks consistent with the presence of PVC were detected. This confirmed that the silver nanocoated surfaces did indeed have a layer of silver on their surface, and that uPVC discs did not. The stability of the silver nanocoatings when placed in ultrapure water for 24 h was extremely high, at around 99.995–99.996 %. Taken together, these results can be used to assess the suitability of the silver nanocoating for its intended purpose. The high stability of the nanocoating is particularly encouraging as it shows there is limited need for concern regarding ecotoxicity, and as it is consistent with previous findings.

The pipe cement-based silver nanocoating described and characterised here, including grinding step, is taken forward in the following chapters to assess its antibacterial activity under different experimental conditions against a range of relevant bacteria.

### 3.5. CONCLUSION

---

## Chapter 4

# Antibacterial efficacy of the silver nanocoating *in vitro* against a panel of nosocomial pathogens

### 4.1 Introduction

In Chapter 3, a pipe cement-based silver nanocoating on uPVC was developed for application to surfaces in hospital WPS, chiefly the periphery of the WPS, which includes the sink trap and surrounding pipework. The nanocoating was then characterised from a materials engineering point of view. In this chapter, the nanocoating is assayed in a laboratory setting to ascertain its antibacterial, namely antiplanktonic and antibiofilm, activity against relevant nosocomial pathogens. The use of laboratory-based *in vitro* bioassays has the advantage of allowing relatively close control of variables such as temperature, medium, bacterial inoculum and physical movement. Plate-based assays for the investigation of biofilm formation and antibacterial properties have previously been used to test a silver nanocoating on human dentine (Besinis, De Peralta and Handy, 2014a), to test silver, titanium dioxide and hydroxyapatite nanocoatings on titanium alloy (Besinis et al., 2017), and to test antifungal properties of silver



#### 4.1. INTRODUCTION

---

nanocoatings on silicone maxillofacial prostheses (Meran et al., 2018). They have also been used to test the antifungal susceptibility of *Candida* biofilms (Nweze et al., 2012), to evaluate methods for chemical decontamination of titanium discs (Ichioka et al., 2021), and to test the antibiofilm activity of an antimicrobial peptide in a tooth model using saliva-coated hydroxyapatite discs (Ansari et al., 2017).

Here, biofilm formation on uncoated uPVC discs and those coated with pipe cement (PC), either alone or incorporating silver nanoparticles (Ag-PC), is quantified by classical enumeration of bacteria within detached biofilm, by regrowth assay of detached biofilm in broth culture, and by use of the metabolic dye resazurin. The antibacterial activity of the nanocoating against planktonic bacteria is also assessed by enumeration. These assays cover a range of possible quantification techniques both requiring biofilm detachment (enumeration, regrowth assays) and not (resazurin assay), thereby seeking to account for bias introduced by the biofilm removal process and any associated loss of culturability. The release of silver from nanocoated surfaces is also quantified to give an indication of the extent of leaching from the coating during exposure to bacteria. Measurement of the extent of silver leaching from the nanocoating allows an understanding of the potential ecotoxicological impact (Courtois et al., 2019) of use of the nanocoatings described as well as their likely useful life due to depletion of silver. This is relevant to understand whether, during the bacterial exposure experiment, bacterial involvement in the form of metabolites or other chemical products may affect the stability of the silver nanocoating through affecting silver dissolution or the structural integrity of the nanocoating matrix (Rodrigues et al., 2013; Weller et al., 2022).

Resazurin (7-hydroxy-10-oxidophenoxazin-10-ium-3-one), available commer-

#### 4.1. INTRODUCTION

---

cially as alamarBlue®, is a cell-permeable phenoxazine dye which is irreversibly reduced to the fluorescent molecule resorufin (Figure 4.1) by aerobic respiration of actively metabolising cells (Chen, Steele and Stuckey, 2018). Originally proposed as an assay for milk testing (McKenzie, 1962), the resazurin assay has previously been used as a rapid test for viability of both eukaryotic (O'Brien et al., 2000; Perrot et al., 2003; Pereira et al., 2020) and bacterial (Sarker et al., 2007; Travnickova et al., 2019; Jia et al., 2020; Labadie et al., 2021; Lescat et al., 2022) cells.

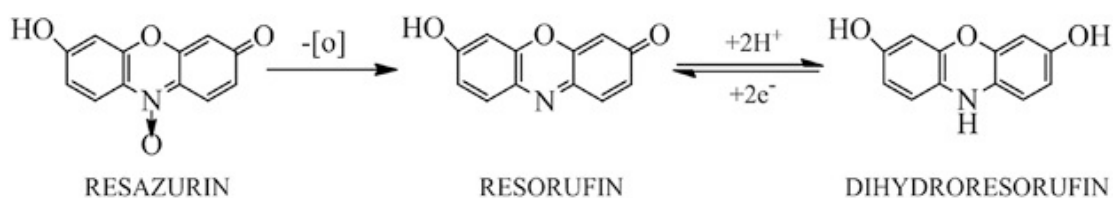

*Figure 4.1:* Reduction of resazurin to resorufin, a strongly fluorescent molecule. When measured at excitation and emission wavelengths of 544 nm and 590 nm, respectively, resazurin is blue and weakly fluorescent, resorufin is pink and strongly fluorescent, and dihydroresorufin is colourless and non-fluorescent. Figure taken from Chen, Steele and Stuckey (2018).

Travnickova et al. (2019) used resazurin to assess the antimicrobial properties of electrospun nanofibre filtration membranes and produced robust calibration curves and data supporting the use of resazurin for *in situ* biofilm quantification, *i.e.* without requiring the intermediary step of dislodging biofilm. The use of the resazurin assay was therefore envisaged here, allowing whole discs following bacterial exposure to be placed in wells - with a rinsing step to remove non-adherent bacteria - containing resazurin and the production of fluorescence then being used as a proxy for *in situ* biofilm. Data are presented here relating to the optimisation of this method, and its use in the measurement of biofilm on discs.

### 4.1.1 Pathogens relevant to nosocomial infections

#### 4.1.1.1 ESKAPE pathogen group

The 'ESKAPE' group consists of six nosocomial pathogens that exhibit multidrug resistance and virulence, so-called because they are frequently able to evade ('escape') killing by common antibiotics (Rice, 2010; Pendleton et al., 2013). These pathogens are generally considered to be:

*Enterococcus faecium*

*Staphylococcus aureus*

*Klebsiella pneumoniae*

*Acinetobacter baumannii*

*Pseudomonas aeruginosa*

*Enterobacter* spp.

This acronym is sometimes extended to 'ESKAPEE', incorporating either *Escherichia coli* or *Enterobacteriaceae* as the additional group (Yu et al., 2020; Ngoi et al., 2021; Akanksha et al., 2022).

In the remainder of this section, only the bacterial species that are relevant to the work in this chapter are described.

#### 4.1.1.2 *Pseudomonas aeruginosa*

*P. aeruginosa* is a Gram-negative, encapsulated, polar flagellated bacillus which causes opportunistic infections in various human body sites including the skin and soft tissue, and the urinary, gastrointestinal, and respiratory tracts (Diggle and Whiteley, 2020). *P. aeruginosa* is known for its ubiquity due to its ability to adapt to and grow in a range of different niches, including on environmental

#### 4.1. INTRODUCTION

---

surfaces, on plants and animals, on skin, and within the body sites of humans (Diggle and Whiteley, 2020). *P. aeruginosa* has a potent ability to persist in niches over long periods, including on surfaces in healthcare settings (de Abreu et al., 2014) over time periods between six hours and sixteen months (Kramer et al., 2006; Panagea et al., 2005).

As an opportunistic pathogen and facultative anaerobe, *P. aeruginosa* is particularly problematic for cystic fibrosis (CF) patients. This is due to environmental strains colonising the thick mucus produced in the respiratory tract due to loss of function of the cystic fibrosis transmembrane conductance regulator (CFTR) protein, rapidly achieving dominance and long-term persistence, and causing significant morbidity and mortality (Malhotra et al., 2019). Up to 80 % of adults with CF become colonised with *P. aeruginosa* (Lambiase et al., 2006; Hauser et al., 2011). The Liverpool epidemic strain is the most common strain in UK CF patients (Williams et al., 2018) with further dissemination reported between continents (Moore et al., 2021). *P. aeruginosa* is generally a risk to individuals with compromised immune systems as well as those with cancer, AIDS, indwelling medical devices, burns and eye injuries, and non-healing diabetic wounds (Diggle and Whiteley, 2020).

Adaptation for long-term persistence is biased towards slow growth, downregulation of virulence factors, motility loss, overproduction of alginate and other factors related to biofilm formation leading to a mucoid phenotype, and hypermutability (Hogardt and Heesemann, 2010). Biofilm formation has been attributed as the main reason for the organism's success in persisting in clinical settings (Thi et al., 2020). *P. aeruginosa* is considered a model bacterium for the study of biofilm formation and can form biofilm in both biotic and abiotic contexts (Diggle and Whiteley, 2020). As well as its ubiquity and frequent

#### 4.1. INTRODUCTION

---

persistence in biofilms, *P. aeruginosa* possesses high levels of intrinsic and acquired resistance to antibiotics (Breidenstein et al., 2011). As a Gram-negative bacterium, low outer membrane permeability contributes to intrinsic resistance (Pang et al., 2019), although the permeability of the *P. aeruginosa* outer membrane is about 12- to 100-fold lower than that of *Escherichia coli* (Hancock and Brinkman, 2002) due to the low efficiency of antibiotic permeation of its chief porin OprF (Nikaido et al., 1991; Bellido et al., 1992).

*P. aeruginosa* has a relatively large genome (5.5–7 Mb) and so it follows that it encodes a large number of products involved in metabolism, transportation and efflux (Pang et al., 2019) allowing great versatility and high adaptability to environmental conditions (Klockgether et al., 2011). Multidrug efflux pumps are particularly relevant to *P. aeruginosa* and are responsible for expelling a range of toxic chemicals including antibiotics across the bacterial envelope. The resistance-nodulation-division (RND) family of bacterial efflux pumps is most relevant to ABR in *P. aeruginosa* (Li and Nikaido, 2009). Of the twelve RND family efflux pumps expressed by *P. aeruginosa*, four (MexAB-OprM, MexCD-OprJ, MexEF-OprN, and MexXY-OprM) contribute to ABR (Dreier and Ruggerone, 2015). Together, these pumps perform efflux of  $\beta$ -lactams, quinolones, and aminoglycosides (Okamoto et al., 2002; Hocquet et al., 2003; Dupont et al., 2005; Llanes et al., 2011). Further ABR is conferred by the production of antibiotic-inactivating enzymes such as  $\beta$ -lactamases, with some *P. aeruginosa* isolates producing ESBLs, leading to overall high levels of resistance to the majority of  $\beta$ -lactam antibiotics (Paterson and Bonomo, 2005; Rawat and Nair, 2010).

##### 4.1.1.3 *Acinetobacter baumannii*

*A. baumannii* is a Gram-negative coccobacillus which exhibits twitching or swarming motility and is known as an opportunistic nosocomial pathogen (Harding et al., 2018). While other members of the genus are predominantly found in soil, *A. baumannii* is most frequently isolated in healthcare environments, and has been described as "undoubtedly one of the most successful pathogens responsible for nosocomial infections in the modern healthcare system" (Lee et al., 2017). The most frequent infections involving *A. baumannii*, with the highest mortality rates, are ventilator-associated pneumonia (VAP) and BSIs (Dijkshoorn et al., 2007) but also include skin, soft tissue and wound infections, UTIs, meningitis and endocarditis (Falagas et al., 2007; McConnell et al., 2013).

*A. baumannii* has colloquially been referred to as "Iraqibacter" due to its emergence in military treatment facilities during Operation Iraqi Freedom in the Iraq War with high incidence of multidrug resistant BSIs (CDC, 2004; Davis et al., 2005; Howard et al., 2012). *A. baumannii* has been described as having become resistant to almost all common antimicrobials, including aminoglycosides, quinolones and broad-spectrum  $\beta$ -lactams (Roca Subirà et al., 2012). A study of over 1450 *A. baumannii* genomes found that gene flow and HGT have driven the dissemination of ARGs both within *A. baumannii* strains and with other organisms such as *P. aeruginosa* and *K. pneumoniae*, concluding that *A. baumannii* has a "highly mobile and even promiscuous resistome" (Hernández-González et al., 2022).

### 4.1.1.4 *Enterococcus faecalis*

*E. faecalis* is a Gram positive, commensal inhabitant of the human gastrointestinal tract which also acts as an opportunistic pathogen (McBride et al., 2007). As a common commensal, *E. faecalis* has been isolated from humans and animals (Fogarty et al., 2003; Layton et al., 2010), as well as from soil and water samples (Fujioka et al., 1998; Byappanahalli Muruleedhara et al., 2012; Weigand et al., 2014). ABR significantly contributes to this organism's pathogenicity in opportunistic infections, with resistance to vancomycin becoming increasingly common. Emerging high-risk, multi-resistant clusters with augmented virulence profiles such as clonal complex 4 have been identified and linked to nosocomial infection (Dai et al., 2018; Migliara et al., 2019). In a study of *E. faecalis* isolates ranging from the pre-antibiotic era in 1936 up to 2018, the apparent hospital adaptations found in hospital-associated *E. faecalis* were concluded to predate the modern hospital era (Pöntinen et al., 2021). It is therefore likely that *E. faecalis* developed these traits due to selection in another niche, and can be considered a fundamental nosocomial pathogen. Biofilm formation potential of *E. faecalis* strains can be variable, though has been shown to be strong in isolates derived from UTIs in China with the *agg*, *esp* and *cyfA* genes particularly linked to the biofilm trait (Zheng et al., 2018). VRE pose an additional concern and therapeutic challenge (Miller et al., 2016). While *E. faecium*, rather than *E. faecalis*, is included on the list of ESKAPE pathogens, *E. faecalis* was historically considered the predominant enterococcus in UK bacteraemias until recently (Horner et al., 2021).

### 4.1.2 Aims

Novel antimicrobial surface coatings are needed to control the growth and persistence of the organisms introduced in Section 4.1.1. In the previous chapter, a silver nanocoating was developed and characterised from a materials engineering point of view. The overall aim of this chapter was to measure the antibacterial, both antibiofilm and antiplanktonic, efficacy of the previously developed silver nanocoating against relevant nosocomial pathogens under controlled laboratory conditions. In addition, there was an aim to conduct an assessment of the stability of the silver nanocoating during exposure to bacteria.

### 4.1.3 Objectives

To achieve the above aims, the following objectives were set:

- Quantify culturable bacteria on the silver nanocoating and compare with those adhered to the control PC coating and uncoated uPVC.
- Quantify culturable planktonic bacteria within media in contact with the silver nanocoating and compare with those exposed to the control coating and uncoated uPVC.
- Quantify the extent of biofilm formation on the silver nanocoating with comparison against the control PC coating and uncoated uPVC using culture-independent means without requiring biofilm detachment.
- Quantify the extent of silver release from the silver nanocoating (*i.e.* leaching) during the course of a bacterial exposure experiment to determine the stability of the nanocoating and assess whether the presence of bacteria changes the extent of silver release.



## 4.2 Materials and methods

### 4.2.1 Bacterial strains

*P. aeruginosa* NCIMB 10817 (ATCC 25619) was cultured from internal stocks at the University of Plymouth curated by Mr Matthew Emery. A clinical isolate of *A. baumannii* was supplied by Dr Lewis Jones at University Hospitals Plymouth NHS Trust. *E. faecalis* NCTC 12697 (ATCC 29212) was cultured from internal stocks kept by the Upton Group at the University of Plymouth. All bacteria were routinely cultured on lysogeny broth (LB) media (Fisher BioReagents, UK). Agar plates were made from dehydrated culture media added to deionised water, solidified by addition of 15 g L<sup>-1</sup> bacteriological grade agar (Acros Organics, UK) and autoclaved at 121 °C and 15 psi for 15 min.

### 4.2.2 General experimental setup

Discs were placed in 24-well culture plates as the substrate for biofilm formation as described previously (Besinis, De Peralta and Handy, 2014a; Besinis et al., 2017; Meran et al., 2018). Overnight cultures were centrifuged three times at 4700 x *g* for 20 min, each time discarding the supernatant and resuspending the pellet in fresh 1% LB broth. After the third spin, suspensions were corrected with sterile broth to an OD<sub>600</sub> of 0.1 and used immediately. Biofilm was routinely formed on uPVC discs by inoculating broth in wells with 150 µL bacterial suspension to a final volume of 1.5 mL per well, giving a starting bacterial density in each well of ~10<sup>6</sup> CFU mL<sup>-1</sup>. Serial dilutions followed by Miles and Misra drop counts (Miles et al., 1938) of inocula were performed on LB agar to confirm their bacterial density. Culture plates were incubated at 37 °C for 24 h with agitation at 120 rpm.

### 4.2.3 Crystal violet solubilisation assay of biomass on uPVC discs

As described in Chapter 2, the CV solubilisation assay is a commonly used method to quantify total microbial biomass, consisting of both bacterial cells and EPS (Merritt et al., 2005). This method is often used to quantify biofilm formation in a 96-well microtitre plate format and so was adapted here to quantify microbial biomass adhered to uPVC discs. Following incubation with bacteria, discs were carefully washed by pipette with 3 mL per side 0.85 % NaCl and left to dry on their side in air. In a 24-well culture plate, discs were each submerged in 500  $\mu$ L of 0.1 % (w/v) CV for 10 min with turning of the discs after 5 min to ensure even exposure. Discs were re-rinsed with 3 mL per side 0.85 % NaCl to remove unbound CV and left to dry in air. Once dry, each disc was submerged in 500  $\mu$ L of absolute ethanol (>99.9%) to solubilise the stain for 10 min on an orbital shaker at 120 rpm at room temperature. After 5 min, discs were turned over to ensure equal exposure of both faces to ethanol. The resulting solution was mixed by pipette before transfer of 100  $\mu$ L to a 96-well microtitre plate in triplicate. Absorbance was read at 575 nm and readings blanked using 100  $\mu$ L of absolute ethanol.

### 4.2.4 Biofilm removal

Sonication is a common method used to detach biofilm from surfaces (Besinis, De Peralta and Handy, 2014a; Besinis et al., 2017; Meran et al., 2018). Briefly, discs were removed from wells following biofilm formation and washed on both sides by pipette with 3 mL per side 0.85 % NaCl to remove non-adherent biomass. Discs were submerged in 2 mL 0.85 % NaCl in a glass vial, vortexed for 5 s, and sonicated in a sonicator bath (35 kHz, Fisherbrand FB 11010, Germany) for 1 min. Vials were then vortexed once again for 5 s.

To compare the effectiveness of sonication at removing biofilms, two alternative methods were devised following the washing of discs with 0.85 % NaCl: mechanical scraping and bead vortexing. The former consisted of holding discs submerged in 2 mL 0.85 % NaCl with fine tweezers and thoroughly scraping surfaces on both sides with a plastic loop. The latter consisted of submerging discs in 2 mL 0.85 % NaCl in a 50 mL centrifuge tube along with 20 sterile glass beads (3 mm diameter) and vortexing for 15 s.

### 4.2.5 Resazurin assay

To test the use of the resazurin assay for detection of bacterial biofilm *in situ*, as has been described previously (Travnickova et al., 2019), *A. baumannii* biofilms were formed on uPVC discs as detailed in Section 4.2.2. Discs were then removed from culture, washed carefully by pipette with 3 mL per side sterile 0.85 % NaCl and left to dry on their side in air. Resazurin solution stocks were prepared at 20 mM in dH<sub>2</sub>O and stored as aliquots at -20 °C. For use, aliquots were thawed and diluted to 20 µM using sterile 0.85 % NaCl. Discs were immersed in 2 mL of 20 µM resazurin solution and incubated statically in the dark at 37 °C. At the given time points, 200 µL aliquots in triplicate were removed and transferred to a 96-well microtitre plate. The plate was read on a FLUOstar Omega microplate reader (BMG Labtech, UK) with excitation wavelength set at 544 nm, emission wavelength set at 590 nm, and gain set at 700. A long-term kinetic measurement was also run to correlate fluorescence production by planktonic bacteria with bacterial density. Tenfold serial dilutions of a bacterial culture were prepared in resazurin solution and 200 µL per well transferred to a 96-well microtitre plate in sextuplicate. The plate was incubated in the microplate reader at 37 °C and automatically read every 30 min using the pa-

rameters described above. At each time point, the mean of the values of the control wells was subtracted from the experimental wells.

### 4.2.6 Minimum bactericidal concentration assay

*P. aeruginosa* and *A. baumannii* were grown at 37 °C in LB broth with shaking, centrifuged at 4700 x *g* for 20 min and resuspended in appropriate medium three times to wash cells of LB media components. OD<sub>600</sub> was then corrected to 0.1 (equating to ~10<sup>7</sup> CFU mL<sup>-1</sup>). Silver nanosolutions were sonicated, as above, for 4 h prior to use. Dilutions of the test material (silver nanoparticles or silver nitrate) were made in the appropriate medium and 225 µL added to wells on a 96-well microtitre plate. 25 µL of the bacterial suspension was then used to inoculate appropriate wells. Microtitre plates were incubated for 18 ± 2 h at 37 °C. The minimum bactericidal concentration (MBC) was derived by pipette mixing wells of the microtitre plate, transferring 10 µL drops of liquid to the surface of LB agar plates in triplicate, and incubating overnight at 37 °C.

### 4.2.7 Quantification of nanocoating antibacterial efficacy through disc exposure experiments

As described in Section 4.2.2, biofilms were formed on discs in a 24-well plate format over 24 h to quantify the antibiofilm and antiplanktonic activity of coated discs compared to uncoated discs. After 24 h, discs were removed from the 24-well plate and a subset were used for *in situ* biofilm quantification by the resazurin assay as described in Section 4.2.5. Other discs were washed with 0.85 % NaCl and sonicated as described in Section 4.2.4. Biofilm-derived cells were quantified by regrowth assay and CFU counts. For the regrowth assay,

0.5 mL of the sonicated suspension from each disc was inoculated into 4.5 mL LB broth in 30 mL tubes and incubated at 37 °C with 120 rpm shaking for 5 h. After 5 h, a spectrophotometer was blanked using 90 % LB broth and the OD<sub>600</sub> of each suspension was measured. For CFU counts, the sonicated suspensions from discs were tenfold serially diluted down to 10<sup>-6</sup> and 10 µL drop counts performed on LB agar using the Miles & Misra method (Miles et al., 1938). Serial dilutions and drop counts were similarly conducted using the broth in wells of the 24-well plates. Together, these drop counts quantified culturable biofilm-derived and planktonic bacteria. Once dry, plates were inverted and placed in an incubator at 37 °C for 18–24 h before counting colonies.

A summary of the general workflow concerning preparation of nanocoatings, the disc exposure experiment, and its outputs can be found in Figure 4.2.

### 4.2.8 Inductively coupled plasma optical emission spectrometry

Total silver in samples was quantified by inductively coupled plasma optical emission spectrometry (ICP-OES), in contrast to ICP-MS used in Chapter 3, due to the higher silver concentrations expected. For ICP-OES measurements, 750 µL aliquots were taken from well media following disc exposure experiments and from saline following sonication of discs. Aliquots were combined 1:1 with 2 % (v/v) nitric acid and stored in the dark at 4 °C for up to four days until measurement. On the day of measurement, all samples were sonicated for 1 h and acidified matrix-matched standards ranging from 0.1–1.5 mg L<sup>-1</sup> were prepared from a multielement standard solution (LabKings, Netherlands). The ICP-OES instrument, an iCAP 7000 Series (Thermo Scientific, UK), was calibrated and checked for conformity to the manufacturer's specifications on a daily basis by technical staff. Analyses were conducted at a wavelength of

## 4.2. MATERIALS AND METHODS

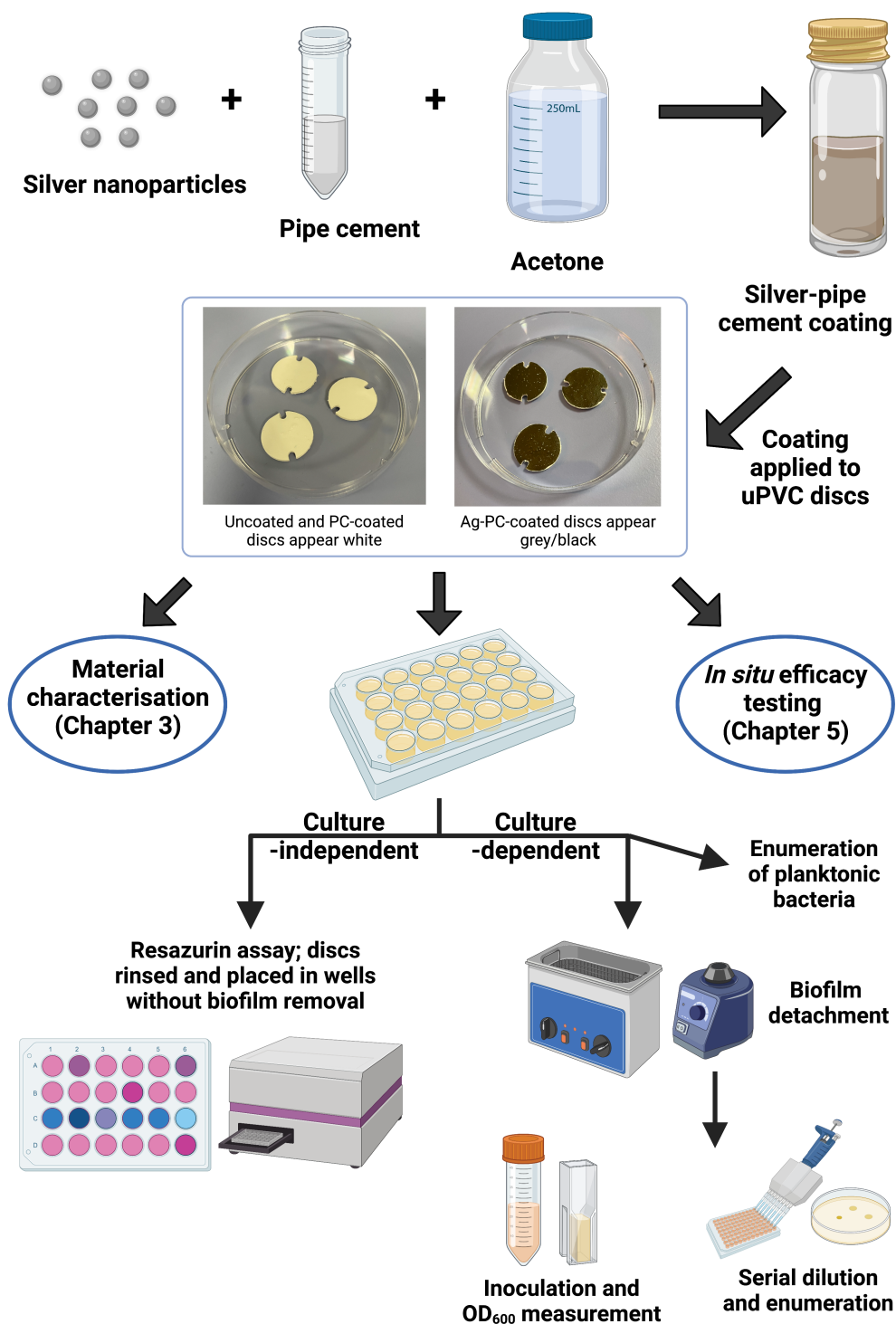

Figure 4.2: General overview of the workflow from preparation of nanocoatings, disc exposure experiments, and their outputs to quantify biofilm and planktonic bacteria. Created with BioRender.com.

328.068 nm for detection of silver. All results were multiplied by two to account for the 1:1 dilution with 2% (v/v) nitric acid performed earlier.

## 4.3 Results

### 4.3.1 Optimisation of methods

#### 4.3.1.1 Use of the crystal violet solubilisation assay to quantify biofilm formation on uPVC discs

The CV solubilisation assay was applied to facilitate quantification of adhered microbial biomass on uPVC discs. Figure 4.3 shows the amount of adhered biomass of *P. aeruginosa* stained by the assay after 24–48 h.

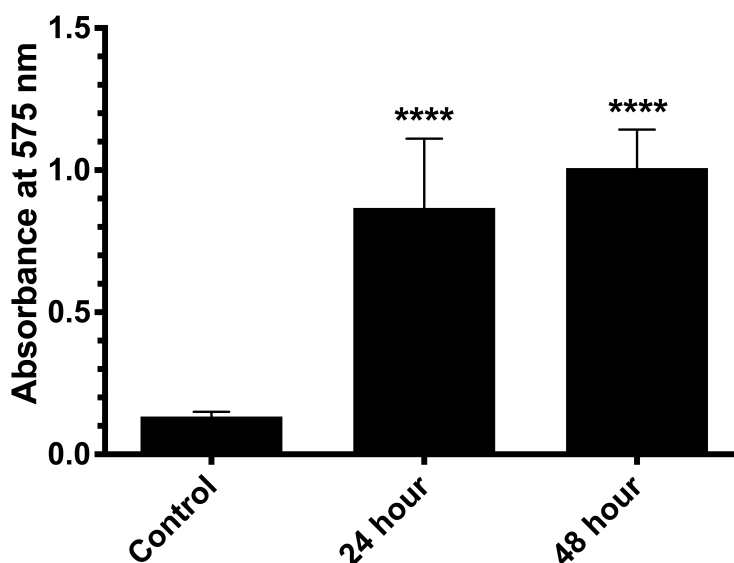

Figure 4.3: Crystal violet solubilisation assay showing adhered biomass of *Pseudomonas aeruginosa* NCIMB 10817 on uncoated uPVC discs over 24–48 h. Control discs were not exposed to bacteria and therefore indicate background crystal violet staining of the uPVC disc. Data presented as mean  $\pm$  standard deviation. \*\*\*\*  $p < 0.0001$ ; one-way ANOVA compared to control with Tukey's multiple comparisons test. Data presented are the average of  $n=3$  biological replicates.

#### 4.3. RESULTS

Figure 4.3 demonstrates that the CV solubilisation assay is an effective method to quantify adhered biomass on uncoated uPVC discs, and illustrates that uPVC discs are a suitable substrate for biofilm formation in this experimental setup. Therefore, an attempt was made to continue its use for later antibiofilm assays with pipe cement-based silver nanocoatings. Figure 4.4 shows the results of CV solubilisation assays completed following incubation with *P. aeruginosa* over 24–72 h for uncoated discs (uPVC), discs coated only with pipe cement as a no particle control (PC), and discs coated with silver nanoparticles in a pipe cement matrix (Ag-PC).

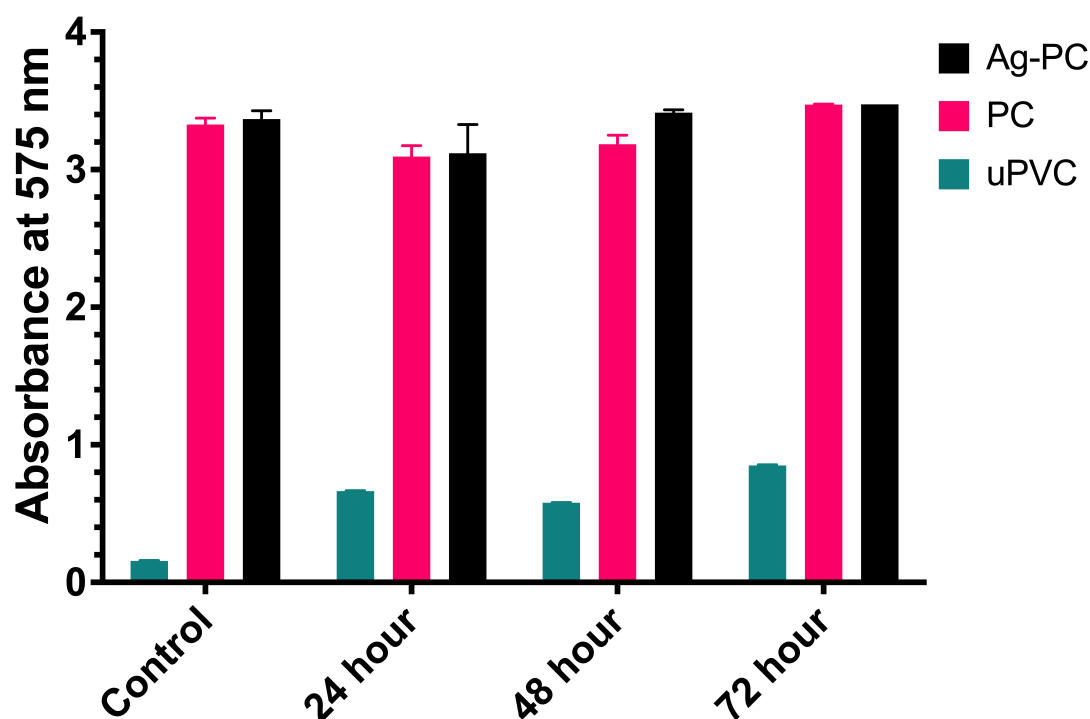

Figure 4.4: Crystal violet solubilisation assay of uncoated (uPVC), pipe cement coated (PC), and silver-pipe cement coated (Ag-PC) discs following incubation with *Pseudomonas aeruginosa* NCIMB 10817 over 24–72 h. Control discs were not exposed to bacteria and therefore indicate background crystal violet staining of the uPVC disc. Data presented as mean  $\pm$  standard deviation. Data presented are the average of  $n=3$  biological replicates.



### 4.3. RESULTS

---

While biofilm formation over 24–72 h can be seen for the uPVC group in Figure 4.4 (green bar), both of the pipe cement-based coated groups (pink and black bars) show a high degree of staining, even in the unexposed control. This level of staining of pipe cement-coated groups suggests that the coating itself exhibits a high degree of background staining which would obscure any staining due to bacterial biomass. The maximum possible value given by the spectrophotometer used for this assay is 3.5, illustrating that the level of staining of the pipe cement-coated groups approached total signal saturation.

#### 4.3.1.2 Comparison of biofilm removal methods

Figure 4.5 shows the results of a CV solubilisation assay following attempts to remove a 24 h *P. aeruginosa* biofilm from the surface of uPVC discs by various methods. A lower absorbance indicates greater biofilm removal compared to control (no attempt at removal made).

Scraping was not found to significantly remove bacterial biofilm ( $p = 0.2958$ ) while each of the other methods (sonicating, sonicating and scraping, and bead vortexing) did significantly remove biofilm ( $p < 0.0001$ ). However, no more significant biofilm removal was achieved by following sonication with scraping ( $p = 0.2332$ ) or by bead vortexing rather than sonicating ( $p = 0.7769$ ).

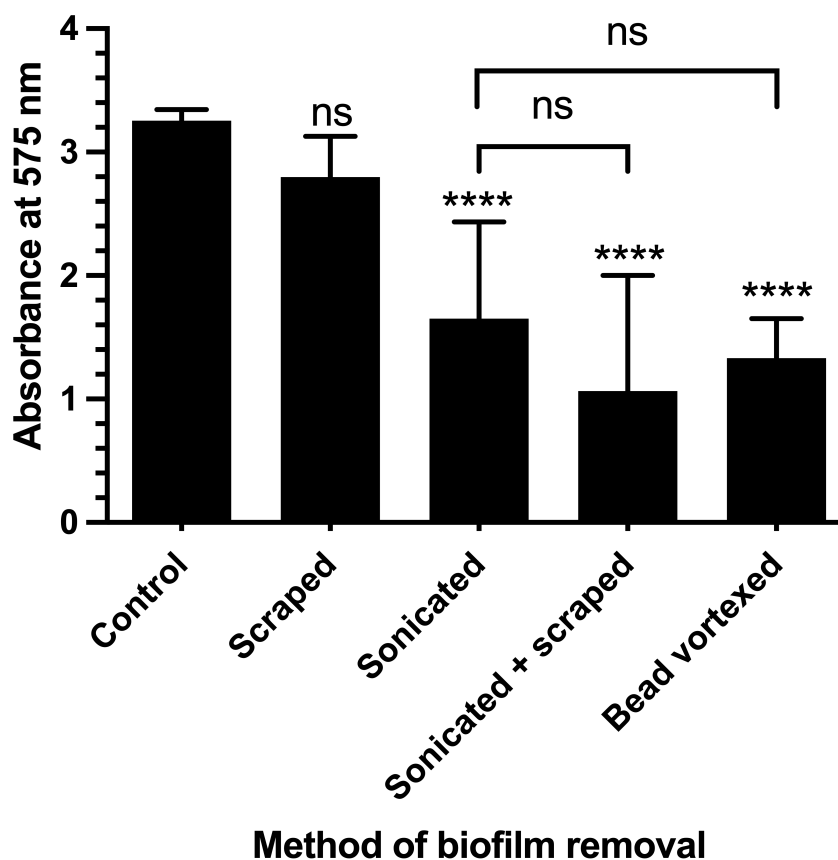

Figure 4.5: Crystal violet solubilisation assay of uncoated uPVC discs following 24 h incubation with *Pseudomonas aeruginosa* NCIMB 10817 and attempts by different methods to remove biofilm. The control group represents discs where no attempt was made to remove biofilm. Data presented as mean  $\pm$  standard deviation. \*\*\*\*  $p < 0.0001$ , ns = not significant; one-way ANOVA compared to control with Tukey's multiple comparisons test. Data presented are the average of  $n=2$  biological replicates.

#### 4.3.1.3 Resazurin assay for *in situ* biofilm quantification

The resazurin assay was tested for use as a metabolic assay for quantification of *in situ* biofilm, *i.e.* without removing biofilm from discs. Figure 4.6 shows the production of the fluorescent product resorufin over 5 hours by biofilm-dwelling bacteria, while the control group (resazurin solution alone in wells) indicates background fluorescence.

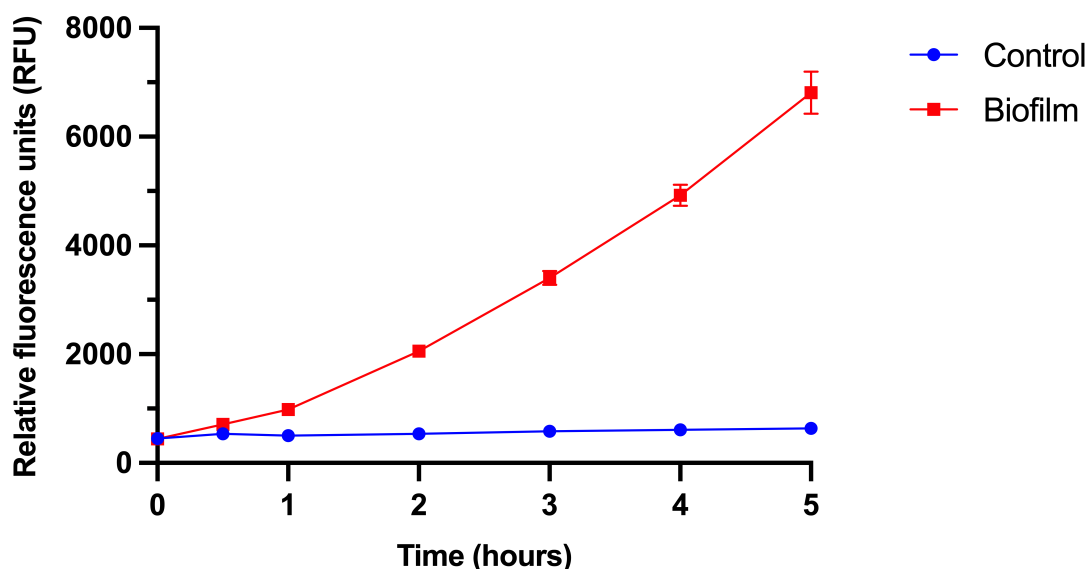

Figure 4.6: Resazurin assay showing production of fluorescent resorufin over 5 h from intact *Acinetobacter baumannii* clinical isolate biofilms on uPVC discs. The control shows the fluorescence of wells containing only resazurin solution, indicating background fluorescence. Data presented as mean  $\pm$  standard deviation. Data presented are the average of  $n=3$  biological replicates.

The 5-hour time frame of fluorescence detection presented in Figure 4.6 allows for the assay to be completed on the same day as disc retrieval from experimental conditions, and acts as a robust biofilm detection and quantification method without requiring biofilm removal from discs. To confirm that the production of fluorescent resorufin by the metabolic activity of bacteria is proportional to bac-

### 4.3. RESULTS

terial density, an overnight kinetic measurement of tenfold serial dilutions of a planktonic bacterial community was conducted (Figure 4.7).

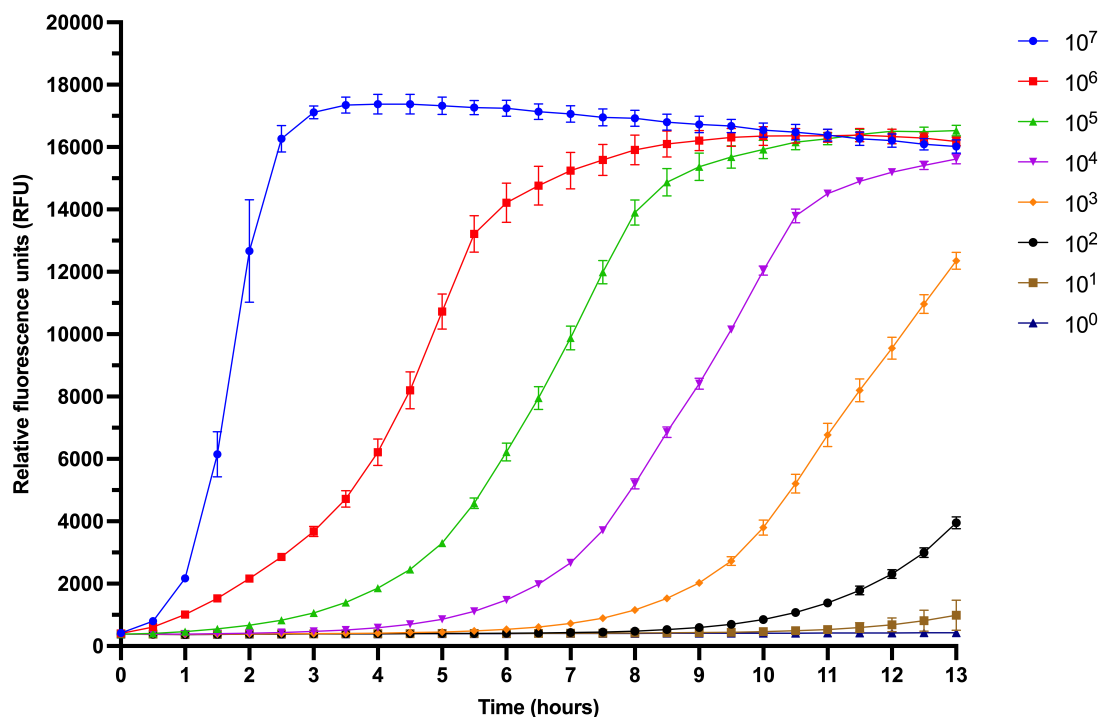

Figure 4.7: Kinetic measurement of fluorescence over 13 h with different starting densities of an *Acinetobacter baumannii* clinical isolate in resazurin solution. The key refers to the starting bacterial densities in colony-forming units (CFUs). Data presented as mean relative fluorescence units  $\pm$  standard deviation with control values (wells containing resazurin solution and no bacteria) subtracted at each time point. Data presented are the average of  $n=3$  biological replicates.

The production of resorufin from resazurin proceeds much faster in higher bacterial densities (Figure 4.7, blue line). However, resorufin production only proceeds until the resazurin supply is depleted, as indicated by the fact that the  $10^7$  CFU group (blue line) reaches a maximum point and plateau at 17 346 RFU after 3.5 h. Furthermore, resorufin undergoes additional reduction to the non-fluorescent molecule dihydroresorufin which may account for the gradual drop

### 4.3. RESULTS

in fluorescence in those groups which reach their peak, chiefly the  $10^7$  CFU group which drops from a peak of 17 374 RFU after 4.5 h to 16 022 RFU after 13 h. Over 13 h, clear resorufin production is seen in groups with starting bacterial densities ranging from  $10^7$ – $10^2$  CFU, indicating good sensitivity of this assay.

#### 4.3.2 Minimum bactericidal concentration of silver in varying media conditions against *P. aeruginosa* and *A. baumannii*

The MBCs of silver nanoparticles and silver nitrate were determined against *P. aeruginosa* and *A. baumannii* in LB broth, dilutions of LB broth, and normal 0.85 % NaCl saline (Table 4.1). Dilutions of LB broth were investigated as it was hypothesised that the protein content of bacteriological media had the potential to confer a ‘blocking’ effect against nanocoatings; dilute media were also under consideration to improve the realistic nature of assays, bringing them closer to nutrient-poor conditions found in WPS as conducted previously (Kotay et al., 2020; Garratt et al., 2021; Butler et al., 2022).

Table 4.1: Minimum bactericidal concentrations of silver in the form of either silver nanoparticles (Ag NPs) or silver nitrate ( $\text{AgNO}_3$ ) when presented to *Pseudomonas aeruginosa* NCIMB 10817 and an *Acinetobacter baumannii* clinical isolate in different media conditions, determined by the broth microdilution method followed by plating on agar.

	<i>P. aeruginosa</i>		<i>A. baumannii</i>	
	Ag NPs	$\text{AgNO}_3$	Ag NPs	$\text{AgNO}_3$
<b>100 % LB</b>	1250 $\mu\text{g mL}^{-1}$	8 $\mu\text{g mL}^{-1}$	625 $\mu\text{g mL}^{-1}$	4 $\mu\text{g mL}^{-1}$
<b>10 % LB</b>	625 $\mu\text{g mL}^{-1}$	8 $\mu\text{g mL}^{-1}$	78 $\mu\text{g mL}^{-1}$	<0.5 $\mu\text{g mL}^{-1}$
<b>1 % LB</b>	16 $\mu\text{g mL}^{-1}$	1 $\mu\text{g mL}^{-1}$	32 $\mu\text{g mL}^{-1}$	<0.5 $\mu\text{g mL}^{-1}$
<b>Saline</b>	4 $\mu\text{g mL}^{-1}$	1 $\mu\text{g mL}^{-1}$	1 $\mu\text{g mL}^{-1}$	<0.5 $\mu\text{g mL}^{-1}$

### 4.3. RESULTS

The results for both *P. aeruginosa* and *A. baumannii* in Table 4.1 show a clear trend for silver nanoparticles where MBC values are higher as the concentration of the bacteriological media increases. While there is a slight tendency in this direction for silver nitrate, the MBC values remain relatively low at a maximum of  $8 \mu\text{g mL}^{-1}$  versus a maximum of  $1250 \mu\text{g mL}^{-1}$  for silver nanoparticles. Generally, MBC values were lower against *A. baumannii* than against *P. aeruginosa* for both silver nanoparticles and silver nitrate.

#### 4.3.3 Antibiofilm activity of the silver nanocoating against *P. aeruginosa*, *A. baumannii* and *E. faecalis*

Figure 4.8 shows the antibiofilm activity of the silver nanocoating against three representative organisms.

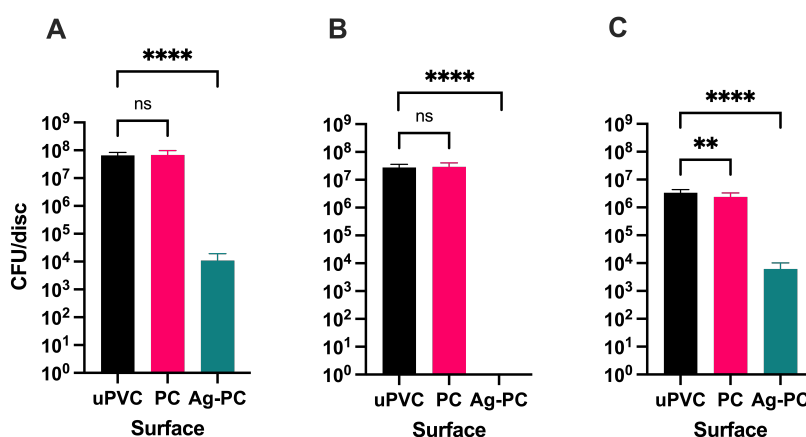

Figure 4.8: Recovery of culturable bacteria from discs, indicating extent of biofilm formation over 24 h, for *Pseudomonas aeruginosa* NCIMB 10817 (A), an *Acinetobacter baumannii* clinical isolate (B), and *Enterococcus faecalis* NCTC 12697 (C). CFU, colony-forming units; uPVC, unplasticised polyvinyl chloride; PC, pipe cement coating; Ag-PC, silver-pipe cement coating. Data presented as mean  $\pm$  standard deviation. \*\*\*\*  $p < 0.0001$ , \*\*  $p < 0.01$ , ns: not significant; one-way ANOVA with Tukey's multiple comparisons test. Data presented are the average of  $n=3$  biological replicates.

### 4.3. RESULTS

In Figure 4.8, the  $\log_{10}$  differences between the uncoated uPVC and Ag-PC coating groups equate to  $-3.9$  for *P. aeruginosa* (A),  $-7.2$  for *A. baumannii* (B), and  $-2.9$  for *E. faecalis* (C). In percentage reduction terms, these differences equate to 99.98 %, 100 % and 99.82 %, respectively.

Antibiofilm activity was also determined by broth regrowth assay of biofilm cells following detachment from discs and inoculation in broth with 5 h incubation (Figure 4.9). Significantly more growth was evident from uncoated and PC coated discs compared to Ag-PC coated discs for all three organisms.

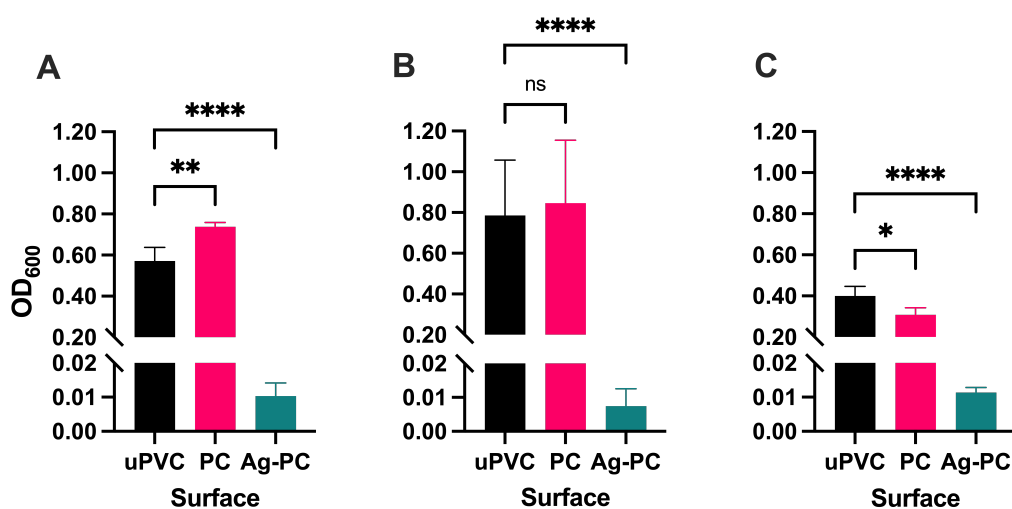

Figure 4.9: Broth regrowth assay of *Pseudomonas aeruginosa* NCIMB 10817 (A), an *Acinetobacter baumannii* clinical isolate (B), and *Enterococcus faecalis* NCTC 12697 (C) biofilm cells. uPVC, unplasticised polyvinyl chloride; PC, pipe cement coating; Ag-PC, silver-pipe cement coating. Data are presented as mean optical density at 600 nm ( $OD_{600}$ )  $\pm$  standard deviation. \*\*\*\*  $p < 0.0001$ , \*\*  $p < 0.01$ , \*  $p < 0.05$ , ns: not significant; one-way ANOVA with Tukey's multiple comparisons test. Data presented are the average of  $n=3$  biological replicates.

The extent of biofilm formation on discs was assessed *in situ* (*i.e.* without removal of biofilm) using the resazurin assay, wherein metabolising cells reduce

### 4.3. RESULTS

resazurin to its fluorescent product resorufin. Figure 4.10 shows the fluorescence quantification of aliquots from discs undergoing this assay following exposure to each of the three representative organisms. Both the uPVC uncoated and PC coated groups show significant production of fluorescence for all three organisms, indicating actively metabolising biofilm cells present, while the Ag-PC-coated group does not show significant fluorescence production.

The fluorescence measurements were around 5.9 fold higher for uPVC and PC groups for *A. baumannii* than for *P. aeruginosa*, although the control and Ag-PC groups show results at around the same level (Figure 4.10), suggesting greater biofilm formation on these surfaces by *A. baumannii* than *P. aeruginosa*.

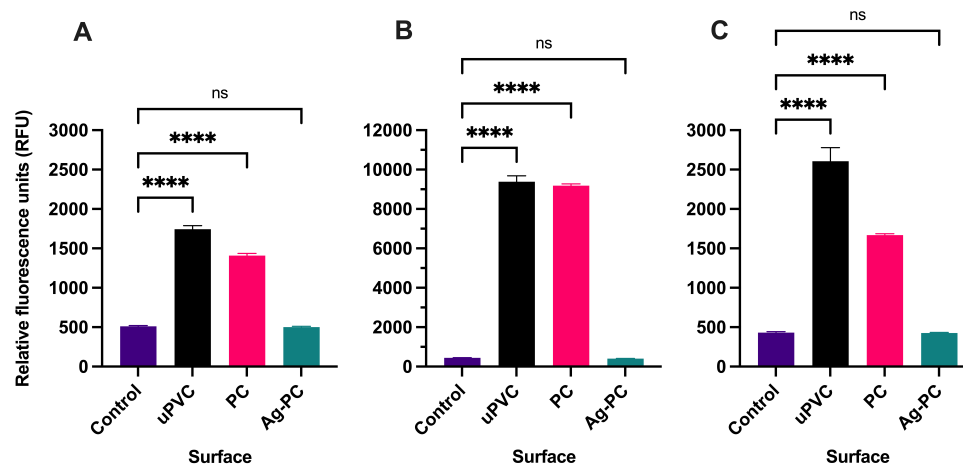

Figure 4.10: *In situ* quantification of biofilm formation by *Pseudomonas aeruginosa* NCIMB 10817 (A), an *Acinetobacter baumannii* clinical isolate (B), and *Enterococcus faecalis* NCTC 12697 (C) on differently coated discs as determined by the resazurin assay. uPVC, unplasticised polyvinyl chloride; PC, pipe cement coating; Ag-PC, silver-pipe cement coating. The control represents wells containing resazurin solution and no disc, indicating background fluorescence and normal reduction leading to fluorescence in these conditions. Data are presented as mean  $\pm$  standard deviation. ns = not significant, \*\*\*\*  $p < 0.0001$ ; one-way ANOVA with Tukey's multiple comparisons test. Data presented are the average of  $n=3$  biological replicates.



### 4.3. RESULTS

#### 4.3.4 Antiplanktonic activity of the silver nanocoating against *P. aeruginosa*, *A. baumannii*, and *E. faecalis*

In addition to determining the antibiofilm activity of the silver nanocoating, the antibacterial activity against planktonic bacteria was also investigated. Figure 4.11 shows the results of enumeration of culturable bacteria in the media following disc exposure experiments.

In Figure 4.11, the  $\log_{10}$  differences between the uncoated uPVC and Ag-PC coating groups equate to  $-2.40$  for *P. aeruginosa* (A),  $-4.54$  for *A. baumannii* (B), and  $-2.97$  for *E. faecalis* (C). In percentage reduction terms, these differences equate to 99.59%, 99.99% and 99.89%, respectively.

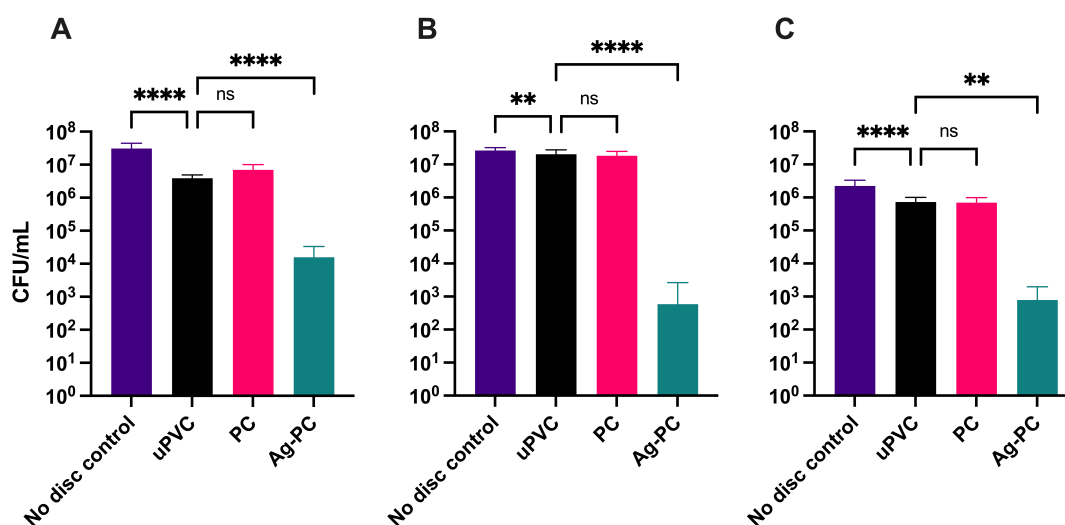

Figure 4.11: Enumeration of planktonic *Pseudomonas aeruginosa* NCIMB 10817 (A), an *Acinetobacter baumannii* clinical isolate (B), and *Enterococcus faecalis* NCTC 12697 following exposure to differently coated discs. uPVC, unplasticised polyvinyl chloride; PC, pipe cement coating; Ag-PC, silver-pipe cement coating. Data are presented as mean  $\pm$  standard deviation. ns = not significant, \*\*\*\*  $p < 0.0001$ ; one-way ANOVA with Tukey's multiple comparisons test. Data presented are the average of  $n=3$  biological replicates.

#### 4.3.5 Release of silver from the nanocoating following disc exposure experiments with bacteria

The amount of silver released into the media during 24 h disc exposure experiments was quantified by ICP-OES. Figure 4.12 shows the concentration of silver detected in the well plate media at the endpoint for each group. The LOD of the instrument across the analyses shown in Figures 4.12 and 4.13 was  $0.009 \text{ mg L}^{-1}$ .

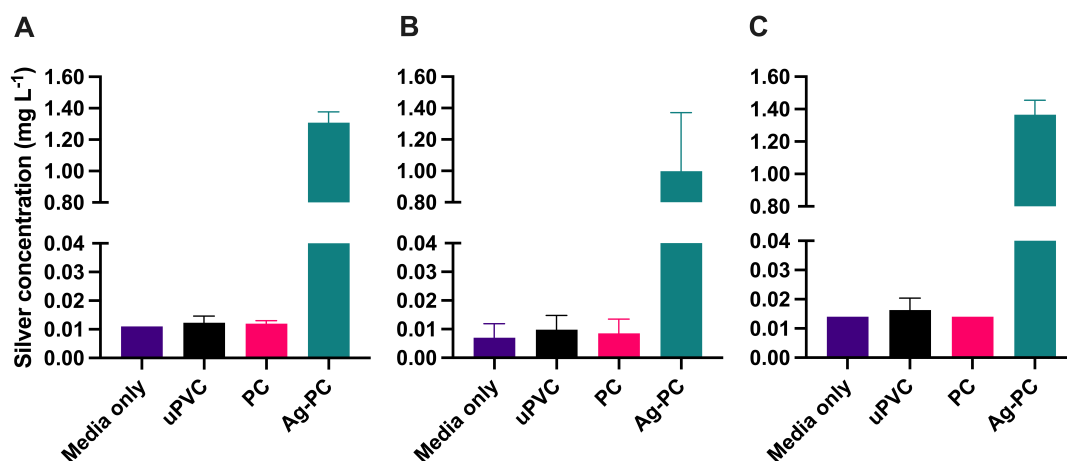

Figure 4.12: Silver release into well media from uncoated and differently coated uPVC discs during bacterial exposure experiments with *Pseudomonas aeruginosa* NCIMB 10817 (A), an *Acinetobacter baumannii* clinical isolate (B), and *Enterococcus faecalis* NCTC 12697 (C). uPVC, unplasticised polyvinyl chloride; PC, pipe cement coating; Ag-PC, silver-pipe cement coating. Data are presented as mean milligrams per litre  $\pm$  standard deviation as measured by inductively coupled plasma optical emission spectrometry. Data presented are the average of  $n=3$  biological replicates.

Figure 4.12 demonstrates that the extent of silver release from the Ag-PC coating during disc exposure experiments was relatively consistent across experiments and between bacterial species, with final mean silver concentrations of  $1.31 \text{ mg L}^{-1}$ ,  $0.99 \text{ mg L}^{-1}$  and  $1.37 \text{ mg L}^{-1}$  for groups exposed to *P. aeruginosa*,

### 4.3. RESULTS

*A. baumannii* and *E. faecalis*, respectively. The levels of silver detected for the groups not containing silver (Media only, uPVC, PC) were around the LOD. Based on the theoretical maximum possible concentration of silver in each well following complete silver dissolution, the percentage final dissolution for the Ag-PC nanocoating exposed to bacteria can be calculated as 0.098 %, 0.074 % and 0.103 % for *P. aeruginosa*, *A. baumannii* and *E. faecalis*, respectively.

#### 4.3.6 Release of silver from the silver nanocoating following sonication

The amount of silver released into the saline during the 60 s sonication for recovery of biofilm cells was also quantified by ICP-OES. Figure 4.13 shows the concentration of silver detected in the saline after sonication for each group.

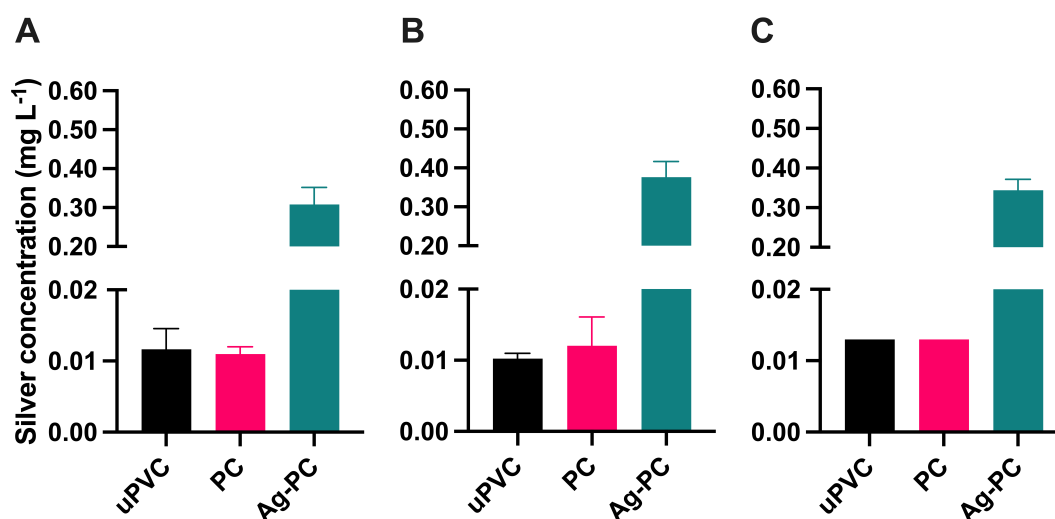

Figure 4.13: Silver release into saline during sonication of uncoated and differently coated uPVC discs following bacterial exposure experiments with *Pseudomonas aeruginosa* NCIMB 10817 (A), an *Acinetobacter baumannii* clinical isolate (B), and *Enterococcus faecalis* NCTC 12697 (C). Data are presented as mean  $\pm$  standard deviation as measured by inductively coupled plasma optical emission spectrometry. Data presented are the average of  $n=3$  biological replicates.

The silver concentrations following sonication for the uPVC uncoated and PC coated groups are around the level of the LOD ( $0.009 \text{ mg L}^{-1}$ ). Those for the Ag-PC group show a relatively consistent release of silver into the media as a result of sonication, giving a final concentration in 2 mL of saline of around  $0.3 \text{ mg L}^{-1}$ . This equates to a silver release due to sonication of approximately 0.03 %.

## 4.4 Discussion

In this chapter, plate-based approaches in a laboratory setting were used to measure the *in vitro* antibacterial efficacy of the silver nanocoating. This approach sought to increase the repeatability of assays between experiments and allow for an assessment of the properties of nanocoatings under controlled conditions. Prior to data collection, methods optimisation steps were required which are discussed first below.

### 4.4.1 Optimisation of methods

As this project utilised uPVC as a substrate rather than titanium, stainless steel, or silicone as had been used previously (Besinis, De Peralta and Handy, 2014a; Besinis et al., 2017; Meran et al., 2018), it was important to evaluate the extent of biofilm formation by relevant bacteria. This was also an opportunity to evaluate the performance of the CV solubilisation assay to quantify the formation of biofilm on discs without requiring its removal. Figure 4.3 demonstrates that *P. aeruginosa* NCIMB 10817 forms a stable biofilm on uPVC in the 24-well format and conditions used, and demonstrates that the CV solubilisation assay can be used to quantify this.

#### 4.4. DISCUSSION

---

It followed that the CV solubilisation assay may be a straightforward and relatively low-cost method of evaluating the antibiofilm performance of silver nano-coated discs without requiring biofilm removal. However, testing of this method showed that discs coated with pipe cement (either incorporating silver nanoparticles or not) exhibited very high levels of background staining where the pipe cement coating itself retained CV and resisted washing (Figure 4.4 on page 151). Due to this, the signal given by any stained biomass would be obscured by the background staining of the coating and it was concluded that this assay could not be used to quantify biofilm formation on pipe cement-coated surfaces. No other studies have been located which describe background staining in the crystal violet solubilisation assay in the context of surface or coatings research.

The removal of biofilm cells from the surface of discs allows for classical bacterial enumeration by culture-based methods or potentially the use of molecular methods to quantify and/or identify the bacteria forming a biofilm using 16S rRNA gene qPCR or 16S rDNA amplicon sequencing. While removal itself is imperfect, and total removal of bacteria can never be guaranteed, it was seen as a necessary step to ensure that there was not an alternative superior method. Sonication has been used extensively to liberate bacteria from surfaces, including MRSA from titanium-aluminium-niobium discs (Scheper et al., 2021), *P. aeruginosa*, *Escherichia coli* and *Staphylococcus aureus* from endotracheal tubes (Latorre et al., 2021), and mixed environmental biofilms from drain plugs (Pirzadian et al., 2020). Bjerkan et al. (2009) reported that sonication is superior to scraping and concluded that scraping of metal surfaces is inadequate as a method for sampling of bacterial biofilm *in vitro*, and Karbysheva et al. (2020) reported that sonication is superior to biofilm dislodgement by chemical methods (ethylenediaminetetraacetic acid or dithiothreitol). Mandakhalikar

#### 4.4. DISCUSSION

---

et al. (2018) investigated different combinations of vortexing and sonication, finding that the vortex-sonicate-vortex method yielded 3–7 times more bacteria from biofilm than the alternative routines such as vortexing or sonicating alone, or such as vortex-sonicate or sonicate-vortex. However, Sandbakken et al. (2020) found that sonication to dislodge biofilm-embedded *Staphylococcus epidermidis* on steel surfaces led to variable results. From the data presented in this thesis and the literature available, one may conclude that sonication is an effective method for bacterial biofilm cell liberation, though the potential variability in results should be borne in mind and other contrasting methods should be sought to confirm any results. To respond to the need for contrasting methods, assays were developed which did not require biofilm removal for quantification.

The resazurin assay was found to be effective for detecting and quantifying *in situ* biofilm from the surfaces of uPVC discs over a period of 5 h (Figure 4.6). This allowed for the quantification of biofilm between differently coated discs without requiring the intermediary step of removing biofilm by any method, allowing direct quantification without the potentially confounding effect of biofilm removal. However, it is possible that the *in situ* resazurin assay may underestimate the amount of biofilm present, either due to incomplete permeation of resazurin molecules through the complex structure of the biofilm, or due to the reduced metabolic activity of cells found in biofilms (Flemming et al., 2016; Singh et al., 2017). This assay also does not quantify the acellular components of biofilm, which form the majority of its dry weight (Flemming and Wingender, 2010). The assay is limited by its mechanism which requires reduction by metabolically active cells (Chen, Steele and Stuckey, 2018).

In addition to facilitating ‘direct’ measurement of bacteria, the use of the resazurin assay was also to respond to the possibility of bacteria entering a vi-

#### 4.4. DISCUSSION

---

able but non-culturable (VBNC) state. The VBNC state was first described in *Escherichia coli* and *Vibrio cholerae* (Xu et al., 1982) and is generally characterised by bacterial cells remaining viable (*i.e.* live) but becoming uncultivable on normally permissive media (Oliver, 2005; Li et al., 2014). It has been observed that bacteria enter the VBNC state in response to stressful conditions (*e.g.* exposure to chlorine, chloramine, UV, or thermosonication) to facilitate long-term survival (Ducret et al., 2014; Chen, Li, Wang, Zeng, Ye, Li, Guo, Zhang and Yu, 2018; Liao et al., 2018; Zhang et al., 2021). VBNC cells have intact membranes (Heidelberg et al., 1997; Cook and Bolster, 2007), continue transcription (Lleò et al., 2000) and translation (Lleò et al., 1998), and are metabolically active (Lleò et al., 2000; Besnard et al., 2002), allowing them to be detected by a range of alternative (culture-independent) assays. Here, the resazurin assay was utilised, which relies on the irreversible reduction of the non-fluorescent phenoxazine dye resazurin to the fluorescent product resorufin, thereby exploiting the continued metabolic activity of any potential VBNC cells. This was deemed necessary to perform in contrast to culture-dependent assays to ensure that any cells encountering stress or damage due to the silver nanocoating or process of biofilm removal entering a VBNC state were still quantified (Graham and Feero, 2019; Hu et al., 2021). While the culture-independent and culture-dependent results in this study appeared to be concordant, the sentiments of other authors (Li et al., 2014, 2017; Zapka et al., 2017) should be echoed in encouraging the use of both approaches to avoid any scenario where viable bacterial numbers are underestimated due to the use of culture-dependent methods alone.

##### 4.4.2 Effect of media conditions on the bactericidal activity of silver

The strong bactericidal activity of silver nanoparticles is well known and is the basis of this branch of antimicrobial nanotechnology (Helmlinger et al., 2016; Loo et al., 2018), therefore the finding of high MBC values of silver nanoparticles against *P. aeruginosa* and *A. baumannii* (Table 4.1 on page 156) was unexpected. The proposed mechanism to account for this finding was the formation of a protein corona around the silver nanoparticles which may have reduced their bioavailability and therefore their antimicrobial activity. The protein corona effect is a phenomenon affecting nanoparticles wherein a heterogeneous mixture of proteins bind to nanoparticle surfaces during their interaction with the biological milieu. The protein corona can cause the physical destabilisation and agglomeration of nanoparticles as well as reducing their bioavailability and therefore function (Monopoli et al., 2012; Tenzer et al., 2013; Rampado et al., 2020). Silver nitrate served as an appropriate control, as a  $\text{Ag}^+$  donor which itself is not vulnerable to the protein corona effect. The results (Table 4.1) indicate that the MBC of silver nanoparticles increases with the concentration of the media, and is not meaningfully greater than that of silver nitrate under saline conditions. These data appear to reinforce the argument that a protein corona effect in bacteriological media significantly reduces the bactericidal activity of silver nanoparticles. To further investigate this, a series of experiments utilising saline or PBS with increasing doses of protein (*e.g.* bovine serum albumin) could confirm the specific contribution of protein and confirm the formation of a protein corona. There is also evidence to suggest that the physicochemical properties of silver nanoparticles can affect the composition and thickness of protein coronas (Ashkarran et al., 2012). As this was not a specific focus of this project, and it was not necessary to characterise this aspect, this avenue was



not pursued.

##### **4.4.3 Antibacterial activity of the silver nanocoating *in vitro***

The silver nanocoating was found to exhibit potent antibiofilm activity, with  $\log_{10}$  reductions in biofilm formation of 2.9–7.2. These results were echoed by broth regrowth assays, where significantly reduced growth was seen from Ag-PC discs versus uncoated uPVC and PC coated discs. The resazurin assay was able to confirm these findings, showing no significant fluorescence production above control for any of the three bacterial strains. As the resazurin assay is less sensitive to very low bacterial numbers, particularly when conducted over a 5 h period (see Figure 4.7), it is not surprising that the resazurin assay was not able to detect low levels of biofilm whereas the CFU enumeration methods were able to do so. The strength of the resazurin assay was in the potential detection of any metabolically active, viable, bacteria which were not culturable and therefore would not be captured by classical culture-based enumeration methods.

In addition to antibiofilm activity, significant antiplanktonic activity was demonstrated for all three bacterial strains (Figure 4.11). The no disc control in each experiment demonstrated more bacteria in the planktonic phase than in wells containing uPVC discs, presumably due to the increased substrate for biofilm formation in wells containing discs meaning that bacteria leave the planktonic phase and become sessile.  $\log_{10}$  reductions in planktonic bacterial numbers ranged from 2.4–4.5. Antiplanktonic activity is related to release of silver from the nanocoating in Section 4.4.4 below. While the main purpose of the developed silver nanocoating was to confer antibiofilm activity, antiplanktonic activity is encouraging and contributes to the inhibition of biofilm formation. The an-

tiplanktonic activity would be expected to be reduced under 'flow conditions', *e.g.* in WPS, in contrast with well plate conditions where the released silver accumulates in the media.

#### 4.4.4 Nanocoating stability

As described in Chapter 3, it is important to quantify the dissolution of silver from the nanocoating as a means of determining its stability, as this can affect assessments of toxicity and longevity. Figure 4.12 indicates the release of silver into wells of the 24-well plate during disc exposure experiments. Comparing the results here (0.074–0.103 % dissolution) with those in Chapter 3 (Section 3.3.4), where a dialysis assay was run in Milli-Q water and the dissolution of silver quantified by ICP-MS (0.004 % dissolution from ground discs), it is evident that greater silver concentrations were detected in dilute bacteriological media (1 % LB) than in Milli-Q H<sub>2</sub>O. The major caveat to this conclusion is that these results were not reached through the same experimental design; the measurements in Chapter 3 came from a dialysis experiment which lacked bacteria, included a dialysis bag to ensure measurement of only dissolved silver, and was under different stirring conditions at room temperature. In contrast, the results presented in this chapter derive from experiments involving bacteria, under not stirring but agitation conditions at 37 °C, and without the use of a dialysis bag. Therefore, the silver detected in the ICP-OES measurements of disc exposure experiments would more accurately be described as 'released', rather than 'dissolved'. To investigate this, a dialysis assay would need to be run using ground silver nanocoatings and with 1 % LB media. This would allow direct comparisons between the results for silver dissolution in Milli-Q H<sub>2</sub>O versus 1 % LB. In contrast to the potential 68 years of 'life' prior to depletion of the

#### 4.4. DISCUSSION

---

silver store suggested in Chapter 3, a release of 0.103 % after 24 h as shown in these conditions would indicate the longevity of the nanocoating to be around 3 years.

It is surprising that such potent antiplanktonic activity was observed, given the relatively small release of silver into the media. Table 4.1 indicates that in 1 % LB, the MBC of silver nanoparticles was  $16 \mu\text{g mL}^{-1}$  against *P. aeruginosa* and  $32 \mu\text{g mL}^{-1}$  against *A. baumannii*, however, these data suggest that the concentrations of silver in the media were far below these levels. Further investigation would be needed to seek an understanding of why low levels of silver release from nanocoatings were able to have such a pronounced bactericidal effect against planktonic bacteria. The use of a no-particle control of pipe cement coatings only ('PC' in Figure 4.11) allowed confirmation that the antiplanktonic activity cannot be attributed to any toxic activity by the pipe cement itself or other chemicals involved such as acetone. Thus, it is logical to assume that the silver nanoparticles in the Ag-PC group are responsible for the antiplanktonic activity demonstrated here, however, the extent of this activity cannot be explained by the data presented here.

Silver release as a result of sonication was minimal over the time frame studied, with final silver concentrations in the 2 mL of saline of  $0.308\text{--}0.376 \text{ mg L}^{-1}$ , equating to 0.031–0.038 % silver release. Discs had to be sonicated to release biofilm for downstream quantification, but the sonication step did not appear to significantly affect the nanocoating integrity. Previous publications describing nanocoating stability following sonication have reported material loss of 0.3–1.1 % (Besinis, De Peralta and Handy, 2014a) and <0.23 % (Besinis et al., 2017). While bacteria being released into suspension during sonication would be exposed to the silver released from the coating, this exposure would be tran-

sient and the concentration of silver in the sonicated media is lower than in the 24-well plate media at the endpoint of the disc exposure experiment, so this silver release should not confound the results regarding viability of detached biofilm cells.

##### **4.4.5 Use of *in vitro* assessment of nanocoating efficacy**

In this chapter, nanocoating antibacterial efficacy was assessed under controlled laboratory conditions, allowing straightforward replication of experiments and known variables. This provides a stable platform on which to perform early assessments of the capabilities of a novel antimicrobial strategy through control of variables such as temperature, medium, flow conditions, and bacterial inoculum. The trade-off of controlled *in vitro* experiments is their potentially artificial nature. Realistic sink traps contain a range of different bacteria, as demonstrated in Chapter 2, and undergo long periods of stagnation followed by sudden and potentially turbulent flow conditions when the sink is in use. In addition, the temperature of a real sink trap has the potential to vary quite significantly, with warm water from handwashing leading to higher temperatures (and sink design contributing to differences in the insulation of the warm water in the trap), followed by cooling and variable temperature lows depending on external weather conditions, time of year, building heating and cooling, and myriad other factors. The liquid medium within a real sink trap is likely to contain a highly heterogeneous, and potentially quite unpredictable, mixture of soaps, dirt and grease, bodily fluids and secretions, sloughed off skin cells, hair, and any other materials. The current chapter could have been improved through the use of a more complex biofilm setup, for example by using a flow cell system in which biofilm is formed on surfaces under hydrodynamic conditions of flow

(Sternberg and Tolker-Nielsen, 2006; Crusz et al., 2012). However, there would then be a need to try to simulate the flushes and stagnation found in sink traps, as they are not under constant flow conditions, which would introduce further variables. In summary, while *in vitro* assessments are valuable for a controlled assessment of antibacterial efficacy, they should be followed by alternative experimental strategies which introduce more realistic variables.

## 4.5 Conclusion

In this chapter, the pipe cement-based silver nanocoating developed and characterised in Chapter 3, along with control surfaces, was subjected to a range of bioassays, under controlled *in vitro* conditions, to assess its antibacterial efficacy. Laboratory methods were first optimised for use in this context, with the CV solubilisation assay being found not to be compatible with pipe cement-based coatings but the resazurin assay fulfilling this role and facilitating *in situ* biofilm quantification without requiring removal from discs. For assays requiring biofilm removal, sonication was found to significantly liberate biofilm while scraping alone did not, and combinations of sonicating and scraping or bead vortexing were not found to be superior, leading to the use of a vortex-sonicate-vortex strategy in this work in line with the literature. The composition of media was found to affect the bactericidal activity of silver nanoparticles to a far greater extent than that of silver nitrate, which may be explained by the well-established protein corona effect. The use of dilute bacteriological media was therefore indicated to avoid this effect, and is also justified by more appropriately simulating the dilute aqueous conditions of sink traps. In antibacterial assays, the silver nanocoating was found to exhibit potent and highly significant antibiofilm and antiplanktonic activity against the three nosocomial biofilm-forming pathogenic

#### *4.5. CONCLUSION*

---

bacteria assayed. The release of silver, both during the 24 h experiments themselves and as a result of sonication during the biofilm quantification assay, was found to be low with a minimum of 99 % nanocoating stability across all conditions.

The data presented here demonstrate that the pipe cement-based silver nanocoating fulfils the aim of developing a low-cost, easy to apply nanocoating for application to plumbing polymer surfaces with antibacterial properties. In the next chapter, the nanocoating is taken forward to more realistic assays in a bench-top laboratory model seeded with a bacterial community from hospital sink trap swabs and real-world sink traps.

#### 4.5. CONCLUSION

---

## Chapter 5

# Antibiofilm efficacy of the silver nanocoating against a hospital sink trap community in a model system and *in situ* in real-world sink traps

### 5.1 Introduction

In Chapter 4, the silver nanocoating was tested for its antibacterial efficacy against a panel of relevant nosocomial pathogens in an *in vitro* setting. The results of Chapter 4 indicated that the silver nanocoating displayed potent antibiofilm and antiplanktonic activity against both Gram positive and Gram-negative bacteria when exposed to single-species inocula under controlled conditions. The work in this chapter sought to improve the realistic nature of experiments by challenging silver nanocoatings with multispecies bacterial communities from hospital sink traps and university building sink traps in a range of conditions.

There are various examples in the literature of previous studies which have sought to emulate the conditions in real-world sink traps. In one study, a UK hospital sink trap was transported to a Public Health England research site and



## 5.1. INTRODUCTION

---

attached to an automated model sink drain system (Garratt et al., 2021). The sink trap was given 21 days to acclimatise and dosed on a daily basis with TSB to maintain the original levels of *Enterobacteriaceae*. This transplanted sink trap was then used to study the effect of long-term exposure to the disinfectant octenidine on selection of *P. aeruginosa*, *Citrobacter* and *Enterobacter* isolates with mutations in efflux pump regulators. The authors showed that *P. aeruginosa* had increased tolerance to octenidine (linked to mutations in the Tet repressor *SmvR*), *Enterobacter* species showed increased tolerance to many cationic biocides and a number of antibiotics (through mutations in *RamR*), and *Citrobacter* species with *RamR* and *MarR* mutations were identified following octenidine exposure and linked to phenotypic antibiotic resistance. Isolates were also demonstrated to retain fitness (in terms of growth, biofilm formation and virulence in *Galleria mellonella*) following octenidine exposure. These results demonstrate hospital sink traps as a reservoir for biocide-tolerant organisms, with low levels of octenidine exposure leading to microbial adaptation to other biocides and cross-resistance to antibiotics. The laboratory model system was originally described by Aranega-Bou et al. (2019) and consisted of 12 individual sinks with associated pipework and bottle-style sink traps built to simulate a clinical setting. This setup allowed investigation of the dispersal of carbapenem-resistant *Enterobacteriaceae* (CRE) from sink traps to the surrounding environment, finding that slow sink drainage and sink designs with the drain situated directly below the tap increased the risk of CRE dispersal from sink traps to the surrounding environment. Other work has employed a dedicated artificial 'sink gallery' composed of five identical sinks set up adjacent to each other, with Plexiglas sheeting between the sinks, and each sink trap linked to a common drainpipe (Kotay et al., 2017). This study setup employed green fluorescent protein (GFP)-expressing *E. coli* to model bacterial dispersal

## 5.1. INTRODUCTION

---

from handwashing sink traps. The study found that when *E. coli* were allowed to form a mature biofilm "under conditions similar to those in a hospital environment", the biofilm extended upwards over 7 days to reach the sink strainer, leading to droplet dispersion to the surrounding areas during tap operation. The study also demonstrated retrograde transmission of bacteria along a common pipe from the effluent side of the WPS towards the sink trap, leading to sink trap colonisation by *E. coli*.

In this work, swabs from hospital sink traps were used to construct a stable, enriched community of realistic hospital sink trap bacteria. This community was used to challenge silver nanocoatings *in vitro* and in a benchtop model sink trap system in order to determine the nanocoating's efficacy against a multispecies hospital sink trap community under reasonably controlled conditions. Silver nanocoated specimens were then placed in multiple real-world sink traps which are 'plumbed in' and actively used, to determine the antibiofilm efficacy of the nanocoating in realistic conditions with comparisons against *in vitro* challenge of nanocoatings using a bacterial inoculum from the same sink traps.

### 5.1.1 Aims

To better simulate the real-world application envisaged for this nanocoating, the work in this chapter aimed to test the silver nanocoating in a benchtop model sink trap system seeded with a hospital sink trap bacterial community, and then in real-world sink traps under realistic conditions.

### 5.1.2 Objectives

To achieve the above aims, the following objectives were set:

- Evaluate the antibiofilm activity of the silver nanocoating against a hospital sink trap community in a benchtop model sink trap system.
- Evaluate the antibiofilm activity of the silver nanocoating in real-world sink traps under realistic conditions.
- Verify experimental results by complementing with *in vitro* disc exposure experiments against the same inocula.

## 5.2 Materials and methods

### 5.2.1 Disc setup

Discs were prepared as described previously (see Section 3.2.3 on page 118). A nichrome wire was heated until glowing using a Bunsen burner and used to melt a hole in the centre of each disc. Discs, nichrome wires and short sections (length 2 mm) of plastic tubing were sterilised by immersion in a 2% NaOCl solution in sterile 50 mL centrifuge tubes, placed on a roller mixer at room temperature for 15 min, and finally triple rinsed with sterile deionised water to remove hypochlorite residue. An image of silver nanocoated discs (Ag-PC) following creation of the central hole and sterilisation can be seen in Figure 5.1.

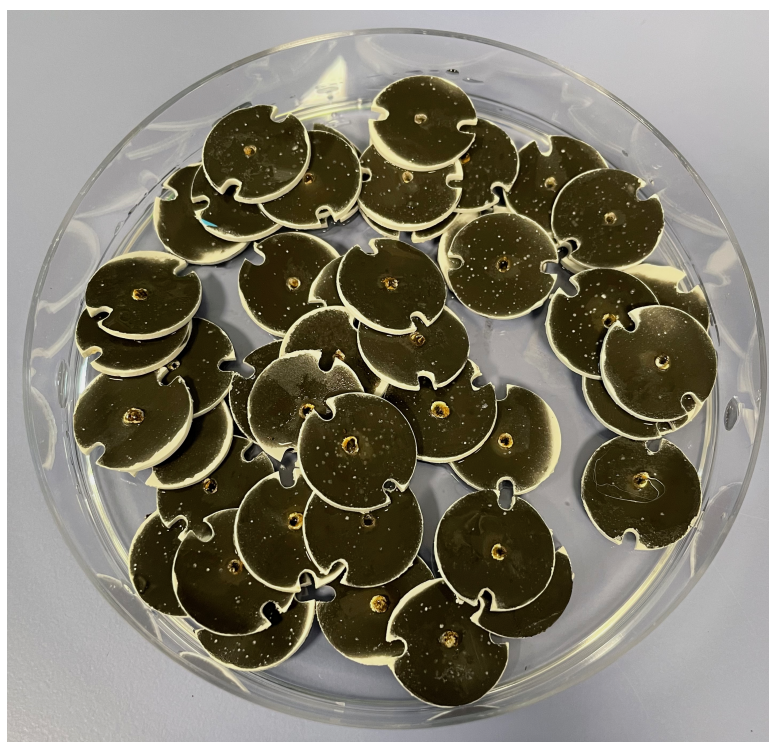

*Figure 5.1:* Appearance of uPVC discs coated with the pipe cement-based silver nanocoating with central holes melted to enable discs to be mounted on nichrome wires.

## 5.2. MATERIALS AND METHODS

---

Discs were aseptically set up by skewering on nichrome wires with sections of plastic tubing acting as spacers to ensure exposure of disc surfaces. Placement of discs on nichrome wires allowed discs to be secured in place when moved into sink traps. An image of the setup can be seen in Figure 5.2.



*Figure 5.2:* Appearance of uPVC discs with different surface finishes mounted on nichrome wires with plastic spacers between discs to facilitate separation.

## 5.2.2 Hospital sink trap community

The sampling of hospital sink traps and subsequent pooling, enrichment, DNA extraction and 16S rDNA amplicon sequencing are described in Section 2.2 (page 70).

## 5.2.3 Laboratory benchtop model sink trap system

### 5.2.3.1 Colonisation

Bottle-style sink traps (A10, McAlpine, UK) were purchased ( $n=3$ ), sterilised with 70% industrial methylated spirits (IMS), assembled, and set up on retort stands on a laboratory bench (Figure 5.3). The 900 mL of enriched hospital sink trap culture made up with ATW from Section 2.2.1 (page 70) was used to fill each sink trap with 300 mL, as this was found to be their approximate maximum capacity. The inlet and outlet ports were sealed with parafilm and sink traps left on the bench at RT for 3 d to allow for bacterial attachment and colonisation. Following this colonisation step, sink traps were subjected to flushing conditions simulating sink usage, by pouring 1 L of ATW into each sink trap via the top inlet port and allowing it to flow out via the bottom outlet.

### 5.2.3.2 Experiments

To begin the experiment, discs set up on nichrome wires (see Figure 5.2) were placed in the sink traps. Each of the 3 sink traps contained 3 nichrome wires skewering discs (uPVC, PC, Ag-PC), such that each sink trap was effectively a replicate. The bacterial densities of the liquid contents of each sink trap were routinely monitored every 1–2 d: a sterile serological pipette was used via the top inlet port to take samples from the base of the sink trap. Samples were

## 5.2. MATERIALS AND METHODS

---

analysed by performing serial dilutions and Miles and Misra drop counts (Miles et al., 1938) on CBA. The goal was to maintain a stable bacterial density in the sink traps, so sink traps were flushed by pouring ATW into the top inlet and allowing it to flow out via the bottom outlet. At the relevant time points, the nichrome wires were lifted out from sink traps using sterile forceps and discs for that time point were aseptically retrieved. The remaining discs were returned to the sink trap immediately. Discs were analysed by detachment and enumeration of biofilm-derived bacteria and resazurin assay as described briefly below (Section 5.2.5) and in detail in Section 4.2.7 on page 147.

## 5.2. MATERIALS AND METHODS

---



*Figure 5.3:* Setup of the laboratory benchtop sink trap model system. Bottle-style sink traps were assembled and set up on retort stands on a laboratory bench with their inlet and outlet ports sealed with parafilm.



## 5.2.4 *In situ* testing of nanocoatings in real-world sink traps

### 5.2.4.1 Study site

The study was conducted across two university buildings (hereafter referred to as A and B) in October to December 2021. Building A consists of research and administrative staff offices, teaching facilities, a café, and laboratories. Building B consists partly of office space but is largely dominated by laboratory space. Four sink traps (STs) were selected in 4 different toilets across the 2 buildings and were assigned numbers 1–4. ST1 and ST2 were in building A, in two male toilets on different floors with a layout including urinals and cubicles (Figure 5.4). ST3 and ST4 were in building B, in neighbouring male and female toilets, with layouts for individual use of a single toilet (Figure 5.5).



*Figure 5.4:* Representative toilet layout of site where sink traps 1 and 2 were located.



*Figure 5.5:* Representative toilet layout of site where sink traps 3 and 4 were located.

### 5.2.4.2 Study design

Sink traps 1–4 were replaced with identical bottle-style sink traps (McAlpine, UK) which had been sterilised with 70% IMS and assembled upon receipt. Discs set up on nichrome wires were placed inside sink traps which were fitted to sinks on day 0. The experiment took place during a period of active building use. At the starting point of the experiment, after sink traps were fitted, the taps were run for 30 s to ensure the traps were filled with water.

At the given time points, sink traps were opened and a 10 mL sample of their liquid contents taken. The remaining contents were then poured off to waste, and nichrome wires retrieved using sterile forceps to remove the required num-

ber of discs. Discs were placed in a sterile closed 24-well plate for transport. After retrieving discs and refitting sink traps, the taps were run once again for 30 s to ensure the traps were filled with water.

All samples were transferred to the laboratory for immediate analysis. The 10 mL aliquot taken from the contents of each sink trap was used to quantify the bacterial density in each trap by serially diluting and performing Miles and Misra drop counts. The remainder of each aliquot was archived at  $-80^{\circ}\text{C}$  both neat and with addition of glycerol to a final concentration of 25% (v/v).

### 5.2.5 Quantification of antibacterial efficacy

Discs from both the benchtop model sink trap system and the *in situ* testing in real-world sink traps were aseptically rinsed with 3 mL of sterile 0.85% NaCl by pipette to remove nonadherent bacteria and debris. For assessment of antibiofilm efficacy, discs were split between two assays: enumeration of biofilm-derived bacteria following detachment by sonication, and the resazurin assay. Assays were completed as described in Section 4.2 starting on page 144.

### 5.2.6 Characterisation of the university building sink trap bacterial community by 16S rDNA amplicon sequencing

Archived samples from sink traps 1–4 without glycerol were thawed from  $-80^{\circ}\text{C}$ , pooled, and metagenomic DNA extracted using the DNeasy<sup>®</sup> PowerSoil<sup>®</sup> Pro kit (Qiagen, Germany) according to the manufacturer's instructions. Extracted DNA was eluted in 50  $\mu\text{L}$  of the elution buffer provided. Extraction yield was quantified using the Qubit<sup>™</sup> dsDNA HS Assay Kit (Invitrogen, MA, USA) and fluorometer (Thermo Fisher Scientific, UK), and purity was determined us-

ing a Nanodrop™ spectrophotometer (Thermo Fisher Scientific, UK). Purified metagenomic DNA was provided to Novogene for sequencing as described in Section 2.2.3.2 on page 74.

### **5.2.7 Disc exposure experiments**

*In vitro* testing of the antibacterial efficacy of the silver nanocoating against the hospital sink trap community and university building sink trap community was conducted as described in Section 4.2.2 (page 144). Bacterial communities from sink traps were used to inoculate cultures in LB broth for setup of these experiments.

## 5.3 Results

### 5.3.1 Antibacterial efficacy of the silver nanocoating *in vitro* against hospital sink trap bacteria

The antibacterial efficacy of the silver nanocoating was assessed *in vitro* against the enriched hospital sink trap bacterial community (Figure 5.6).

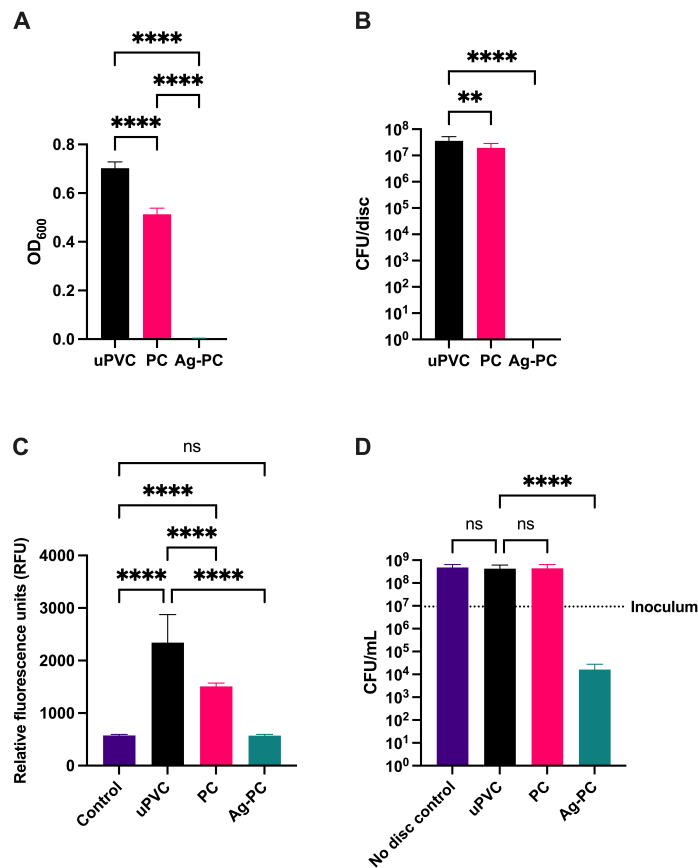

**Figure 5.6:** Antibacterial efficacy of silver nanocoated discs *in vitro* against an enriched hospital sink trap bacterial community over 24 h. Biofilm formation was measured by inoculating detached biofilm bacteria in broth and measuring OD<sub>600</sub> after 5 h (A), by enumeration of detached biofilm bacteria (B), by resazurin assay (C), and by enumeration of planktonic bacteria (D). Data are presented as mean  $\pm$  standard deviation. ns = not significant, \*\*\*\*  $p < 0.0001$ , \*\*  $p < 0.01$ ; one-way ANOVA with Tukey's multiple comparisons test. Data presented are the average of  $n=3$  biological replicates.

Assessments of biofilm formation *in vitro* indicated potent antibiofilm effect with no biofilm-derived bacteria detected by reinoculation, enumeration, or resazurin assay (Figure 5.6A–D). There was also a strong antiplanktonic effect, with the  $\log_{10}$  change in bacterial numbers in the Ag-PC group of  $-4.40$ , equating to a percentage reduction of 99.99% (Figure 5.6D).

#### **5.3.2 Antibiofilm efficacy of the silver nanocoating in a benchtop sink trap model**

The antibiofilm efficacy of the silver nanocoating was assessed against the enriched hospital sink trap bacterial community in a benchtop sink trap model system over a longer time period (Figure 5.7).

The results in Figure 5.7 indicate that after 4 d and 11 d, there was significantly more biofilm present on uPVC surfaces than on Ag-PC surfaces when quantified by both assays (enumeration of biofilm bacteria or resazurin assay). However, at 25 d, this antibiofilm effect was lost with no significant differences between the groups.

During the 25 d benchtop sink trap model study, the density of planktonic bacteria within the traps was routinely enumerated for monitoring purposes. At the starting point of the study, the mean density was  $2.0 \times 10^8$  CFU mL<sup>-1</sup>. At days 4, 11 and 25, the mean densities were  $6.5 \times 10^7$  CFU mL<sup>-1</sup>,  $1.1 \times 10^8$  CFU mL<sup>-1</sup> and  $2.6 \times 10^7$  CFU mL<sup>-1</sup>, respectively.

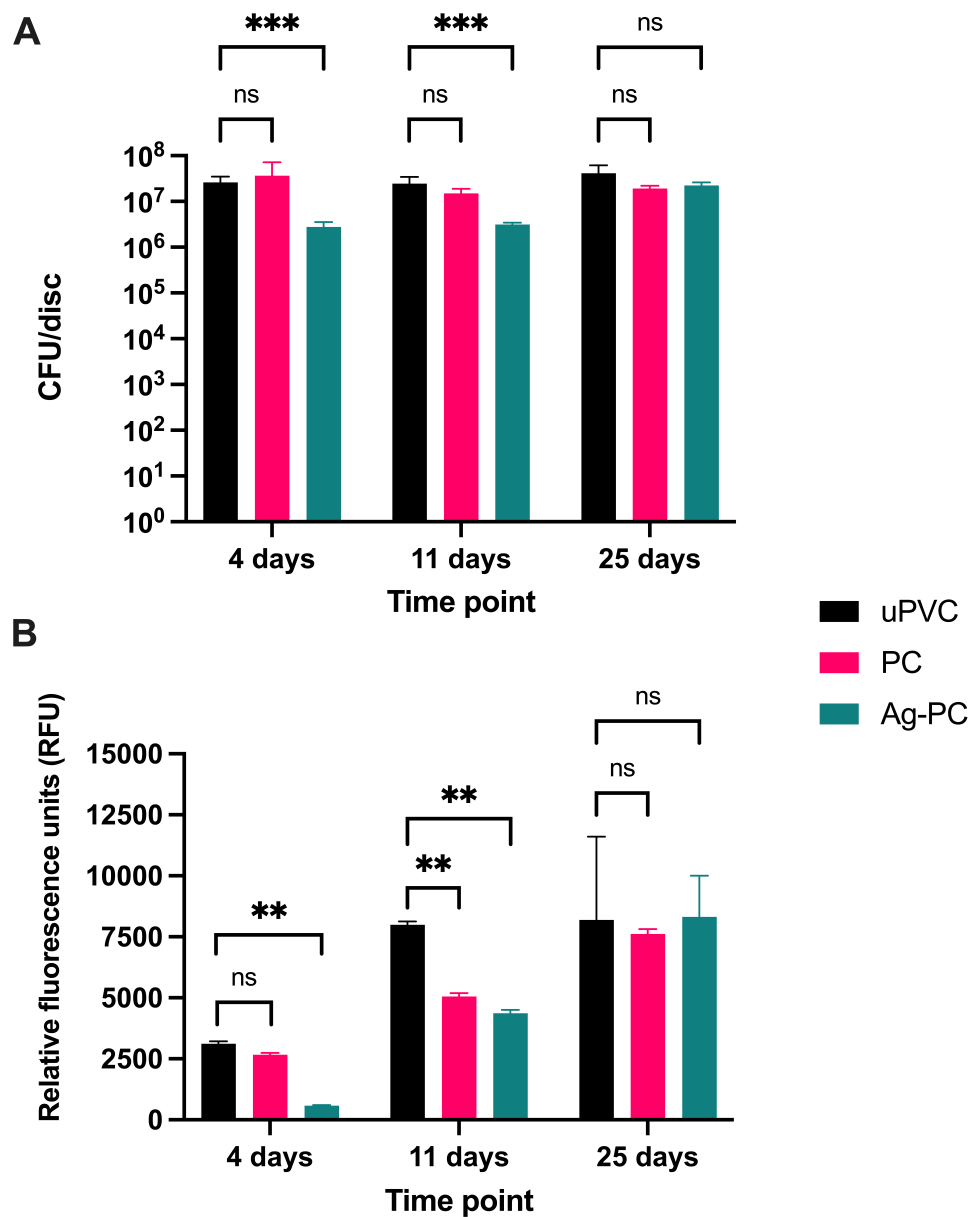

Figure 5.7: Antibiofilm efficacy of silver nanocoated discs in a benchtop sink trap model system following inoculation with an enriched hospital sink trap bacterial community. Biofilm formation was measured by enumeration of detached biofilm bacteria (A) and by the resazurin assay (B). Data are presented as mean  $\pm$  standard deviation. ns = not significant, \*\*\*  $p < 0.001$ , \*\*  $p < 0.01$ ; one-way ANOVA with Tukey's multiple comparisons test. Data presented are the average of  $n=3$  biological replicates.

### 5.3.3 Characterisation of university building sink trap community by 16S rDNA amplicon sequencing

Following the antibacterial activity demonstrated against hospital sink trap bacteria *in vitro*, prior to more realistic antibacterial efficacy assays, it was necessary to characterise the bacteria present in university building sink traps. Samples of the university buildings' sink trap (ST1–4) contents were pooled and the taxa present identified by 16S rDNA amplicon sequencing (Figure 5.8).

Figure 5.8 indicates that the university building sink trap samples were largely dominated by *Citrobacter* (65.6% and 87.7% for V3–4 and V4–5 gene regions respectively), with V3–4 sequencing indicating other genera such as *Desulfovibrio* (11.7%), *Dethiosulfovibrio* (7.6%) and *Anaerophaga* (3.5%) also being present and V4–5 sequencing indicating that *Kluyvera* (8.2%) was also present. Diversity compared to the hospital sink trap samples (Chapter 2) was reduced with a 4.8-fold smaller total number of genera represented ( $n=86$  for hospital sink traps versus  $n=18$  for university building sink traps) when considering genera with  $>50$  reads. There were also some clear differences in the identities of the most abundant genera compared to the hospital sink trap bacteria described in Chapter 2, where the dominant genera were *Citrobacter*, *Pseudomonas*, *Serratia*, and *Azospira*.



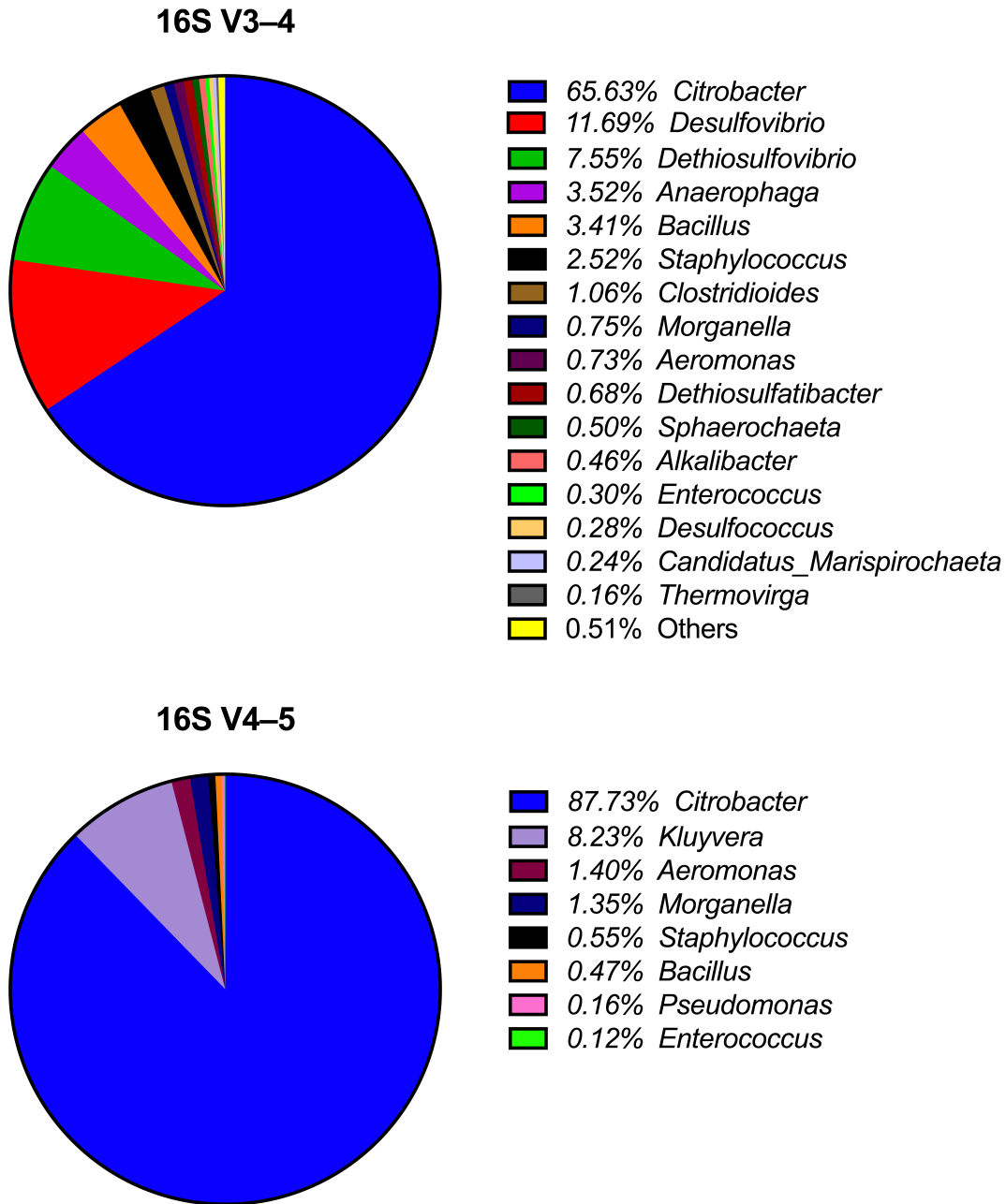

Figure 5.8: Classification of the taxa present in pooled samples from 4 university building sink traps by 16S rDNA amplicon sequencing of V3–4 and V4–5 gene regions. Total reads 70 364 for V3–4 and 120 657 for V4–5.

#### **5.3.4 Antibiofilm efficacy of the silver nanocoating in real-world university building sink traps *in situ***

Discs were placed in real-world sink traps (ST1–4) across two university buildings to investigate the antibiofilm efficacy of the silver nanocoating in realistic conditions. The results are expressed per sink trap (Figure 5.9). Biofilm formation on discs was quantified by detachment and enumeration of biofilm-derived bacteria (Figure 5.9A–D) and using the resazurin assay without prior detachment of biofilm (Figure 5.9E–H).

There were some incidences where biofilm formation appeared to be significantly reduced on Ag-PC surfaces compared to uPVC discs without the no particle control (PC) also showing reduced biofilm formation. These incidences were in ST2 on days 1 and 7 (Figure 5.9B) and ST4 on day 7 (Figure 5.9D) in detached biofilm enumeration results. The resazurin assay results showed more incidences of potential treatment effect, *e.g.* in ST1 on days 7, 14 and 28 (Figure 5.9E), ST2 on days 7 and 14 (Figure 5.9F), and ST4 on days 7 and 14 (Figure 5.9H).

### 5.3. RESULTS

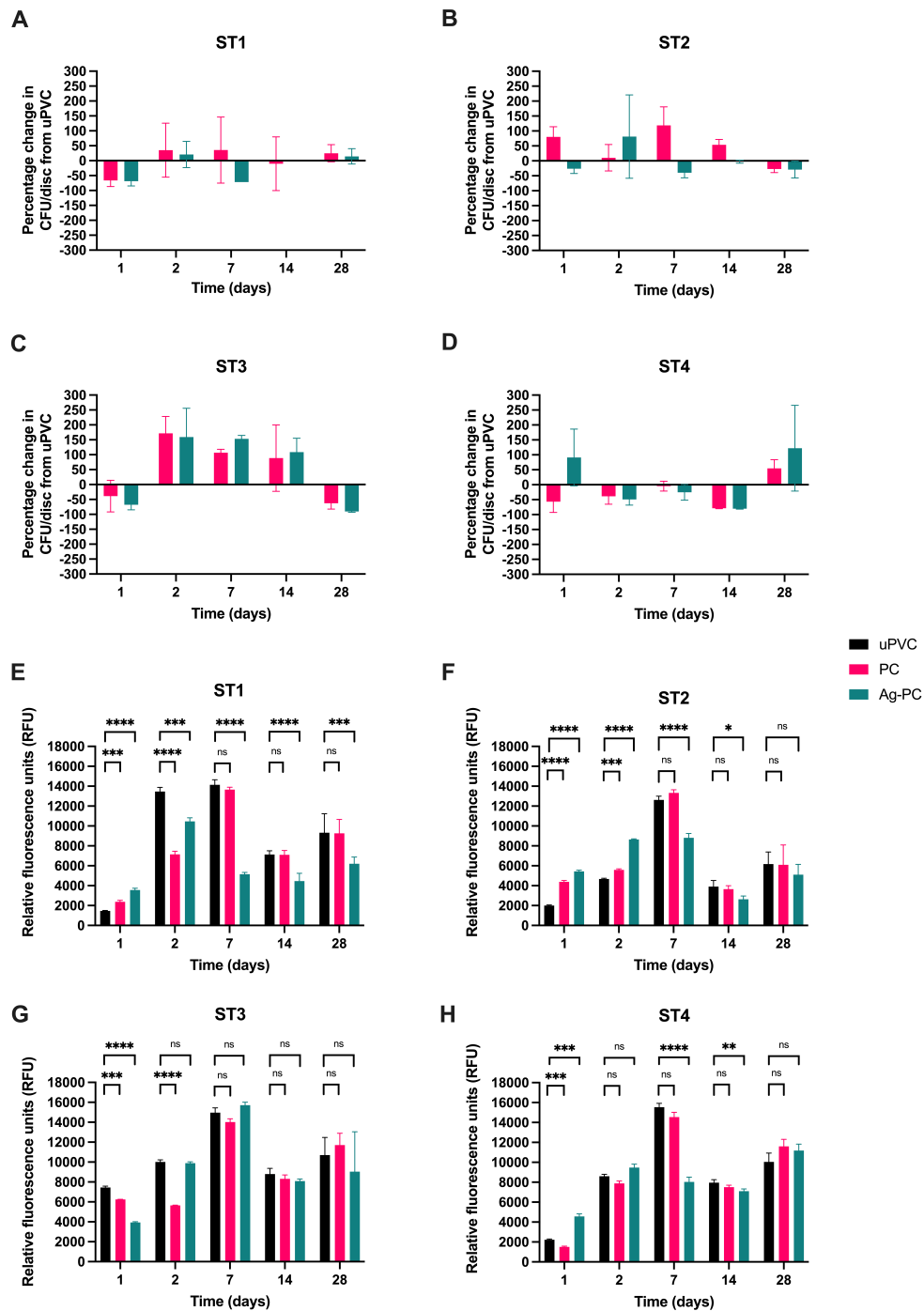

Figure 5.9: Antibiofilm efficacy of silver nanocoated discs *in situ* in real-world university building sink traps (ST1–4). Biofilm formation was measured by enumeration of detached biofilm bacteria (A–D) and by the resazurin assay (E–H). Data are presented as mean  $\pm$  standard deviation. ns = not significant, \*\*\*\*  $p < 0.0001$ , \*\*\*  $p < 0.001$ , \*\*  $p < 0.01$ , \*  $p < 0.05$ ; one-way ANOVA with Tukey's multiple comparisons test.

In ST3, there was an initial reduction in biofilm formation on PC and Ag-PC surfaces compared to uPVC, however, this effect was lost by the next time point (Figure 5.9C and Figure 5.9G). As a point of comparison, there were also incidences of biofilm formation appearing greater on Ag-PC surfaces, *e.g.* in ST4 on day 1 (Figure 5.9D), and incidences of biofilm formation on PC and Ag-PC surfaces being greater than control, *e.g.* in ST3 consistently between days 2–14 (Figure 5.9C) and in ST4 on day 28 (Figure 5.9D).

Overall, the treatment effect in terms of antibiofilm efficacy of the silver nanocoating in real-world sink traps was not strong, and where it was significantly present it was not consistent between time points.

#### **5.3.5 Antibacterial efficacy of the silver nanocoating *in vitro* against university building sink trap community**

Due to the positive results seen *in vitro* but weaker antibacterial efficacy *in situ*, a further set of *in vitro* disc exposure experiments were conducted to test the nanocoating's antibacterial efficacy against the university building sink trap community at both room temperature (RT) and 37 °C (Figure 5.10).

The silver nanocoating exhibited significant antibiofilm activity against the university building's sink trap bacterial community, with mean  $\log_{10}$  changes in biofilm of  $-3.60$  (RT) and  $-2.44$  (37 °C) (Figure 5.10A) and no biofilm detectable by resazurin assay for either temperature condition (Figure 5.10B). There was also significant antiplanktonic activity, with  $\log_{10}$  changes in culturable planktonic bacteria of  $-4.30$  (RT) and  $-1.8$  (37 °C) (Figure 5.10C).

### 5.3. RESULTS

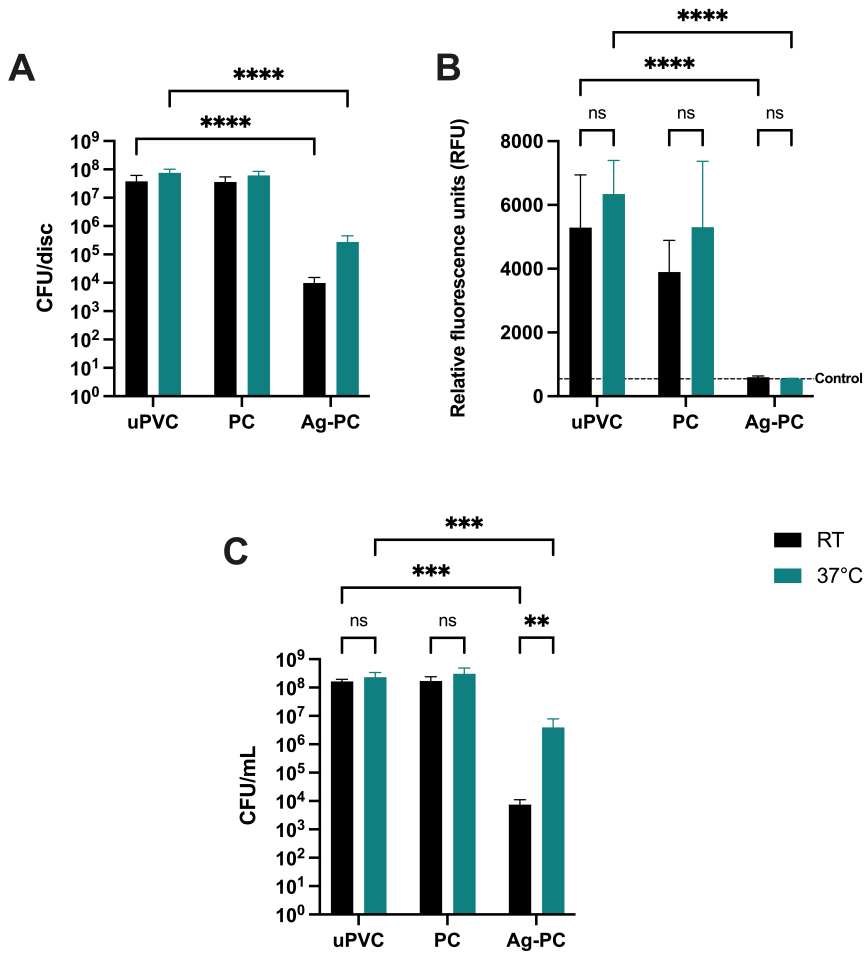

Figure 5.10: Antibacterial efficacy of silver nanocoated discs *in vitro* against the university building sink trap bacterial community. Biofilm formation was measured by enumeration of detached biofilm bacteria (A), by the resazurin assay (B), and by enumeration of planktonic bacteria (C). Data are presented as mean  $\pm$  standard deviation. ns = not significant, \*\*\*\*  $p < 0.0001$ , \*\*\*  $p < 0.001$ , \*\*  $p < 0.01$ ; one-way ANOVA with Tukey's multiple comparisons test. Data presented are the average of  $n=3$  biological replicates.

## 5.4 Discussion

In this chapter, the previously-developed silver nanocoating was taken into experiments in more realistic conditions to assess its real-world antibacterial properties. The antibacterial efficacy against hospital sink trap bacteria was quantified *in vitro*, with strong antibiofilm and antiplanktonic results, before being taken into a benchtop sink trap model system and challenged against the same hospital sink trap community. In this setup, antibiofilm activity was evident after 11 days of exposure to the multispecies hospital sink trap community. In order to move into even more realistic conditions, an '*in situ*' study was planned at University Hospitals Plymouth NHS Trust (UHPNT) and formal approval was sought from the NHS Health Research Authority (HRA). Approval from the Faculty Research Ethics and Integrity Committee at the University of Plymouth was sought and deemed by the Committee not to be required due to the lack of human participants (see Appendix C.1 on page 297). An Integrated Research Application System (IRAS) form was submitted (see Appendix C.2 on page 299) to the HRA with support from UHPNT. The HRA granted approval in February 2021 (see Appendix C.3 on page 329). However, due to restrictions in place in response to the COVID-19 pandemic and the associated pressure on hospitals at the time, the study could not be completed as planned. An alternative approach was taken, transferring the *in situ* study to two university buildings but retaining the study design as proposed.

Sequencing of 16S rDNA amplicons was first employed to identify the taxa present in two university buildings' collective sink traps, before this community was used to challenge the silver nanocoating at both a classically *in vitro* temperature condition of 37 °C and at room temperature, which was deemed more realistic for the nanocoating's intended application. Potent antibiofilm and

antiplanktonic activity was shown once again, as in Chapter 4, against the university building sink trap community *in vitro* for both temperature conditions, although antibiofilm activity was more pronounced at room temperature. Work was planned to culminate in testing of the silver nanocoating in real-world sink traps under active use in the same university building locations. In these *in situ* conditions, while an antibiofilm effect could be described at some isolated points, an overall strong or consistent treatment effect was not observed. Due to this result, further *in vitro* assays were completed to confirm that the silver nanocoating was active against the university building sink trap bacteria under controlled conditions, with potent antibacterial properties demonstrated once again.

##### **5.4.1 Challenge of nanocoatings with single- versus multi-species bacterial inocula**

One of the most artificial features of *in vitro* biofilm studies, including those presented in Chapter 4 of this thesis, is the use of single-species bacterial inocula. It is well-established that most natural biofilms are composed of many bacterial species which cooperate, compete and communicate in myriad ways (Yang et al., 2011; Elias and Banin, 2012). The communal interactions between bacteria in a multispecies biofilm have the potential to lead to certain ‘emergent properties’ such as enhanced tolerance to antibiotics, host immune responses or other stressors (Elias and Banin, 2012; Liu et al., 2016). The efficacy of antimicrobial agents can be significantly reduced in a polymicrobial environment, sometimes by several orders of magnitude (O’Brien et al., 2022). Studies utilising single-species biofilms can be useful in allowing investigation of the biofilm-related behaviours of those single bacterial species, but

ultimately where ‘natural biofilms’ are the intended or target environment, studies should move towards incorporating a more polymicrobial community. In this chapter, this was addressed by challenging nanocoatings with polymicrobial communities from both hospital and university building sink traps in contrast with those assays completed in Chapter 4. The silver nanocoating was just as effective *in vitro* when challenged with these polymicrobial communities as against single-species inocula, with consistent multi-log<sub>10</sub> reductions in biofilm formation equating to >99 % antibiofilm efficacy, and consistent biofilm formation on uncoated uPVC of >10<sup>7</sup> CFU/disc.

#### **5.4.2 Discord between laboratory-based *in vitro* and real-world *in situ* experiments**

While single- and multi-species *in vitro* biofilm assays were generally in agreement with each other, very different outcomes were found between laboratory-based *in vitro* and real-world *in situ* experiments. Consistently strong antibiofilm efficacy was evident against *P. aeruginosa* (Figure 4.8A), *A. baumannii* (Figure 4.8B), *E. faecalis* (Figure 4.8C), a hospital sink trap community (Figure 5.6), and a university building sink trap community (Figure 5.10) when investigated *in vitro*. However, when nanocoated discs were placed in real-world sink traps, the majority of data points showed no significant treatment effect while the treatment effects - where present - were both less potent and less consistent (Figure 5.9). As *in vitro* experiments were conducted under controlled conditions, these results would suggest that the silver nanocoating developed is effective against the bacteria used for *in vitro* challenge, but this efficacy did not translate to *in situ* experiments due to other confounding factors. A build-up of contaminants was visible on discs upon collection during *in situ* experiments, even from the



#### 5.4. DISCUSSION

---

first time points, and so this is likely to explain the failure of silver nanocoatings to inhibit biofilm formation in these conditions.

The formation of a conditioning film under aqueous conditions, where biomolecules adsorb to surfaces and provide a foundation for microbial attachment and biofilm formation by altering the surface's properties, has been documented in the literature (Francius et al., 2017; Bhagwat et al., 2021; Rummel et al., 2021). Sink traps are likely to contain a range of 'debris', including organic matter from drinking water (Francius et al., 2017), dead or sloughed skin cells, hair and dirt from handwashing, and perhaps less frequently a variety of discarded food and drink in some settings (Grabowski et al., 2018). These substances, along with dead bacteria, are likely to form a film on nanocoated surfaces and block the exposure of the antimicrobial nanocoating, thereby nullifying its effects. There is little information available in the literature regarding physical debris in WPS and how it may affect antimicrobial nanocoatings, and the previous studies which have set up artificial sink trap model systems (see Section 5.1 on page 175) have not investigated this area. The silver nanocoating described in this thesis clearly has potential as an antimicrobial surface for application to WPS, as demonstrated by its potent antibiofilm activity against a range of bacteria presented in different formats, however further work would be needed to develop a solution to the potential 'blocking' of the nanocoating surface by physical contaminants. This problem is likely to affect any nanocoating or antimicrobial surface system which relies on exposure of the surface to bacteria, not just those for application to WPS, and therefore is relevant to nanocoatings developed for other settings such as within oral prostheses or implanted medical devices, further highlighting the need for future investigation.

### 5.4.3 Characterisation of the university building sink trap bacterial community

This study employed rDNA amplicon sequencing of the 16S V3–4 and V4–5 regions to identify the microbial taxa present in sink traps of the university building (Figure 5.8). While both regions indicated the dominance of *Citrobacter* (65.6% and 87.7% for V3–4 and V4–5 gene regions, respectively), the different regions sequenced gave relatively divergent results for the genera less dominant than *Citrobacter*. Sequencing of the V3–4 region also detected *Desulfovibrio* (11.7%), *Dethiosulfovibrio* (7.6%), *Anaerophaga* (3.5%), *Bacillus* (3.4%), *Staphylococcus* (2.5%), and *Clostridioides* (1.1%). V4–5 sequencing detected *Kluyvera* (8.2%), *Aeromonas* (1.4%), *Morganella* (1.4%), *Staphylococcus* (0.5%) and *Bacillus* (0.5%), with small proportions of *Pseudomonas* (0.2%) and *Enterococcus* (0.1%). This comparison would seem to suggest that V4–5 sequencing was able to achieve better community resolution, detecting genera that V3–4 sequencing did not. Certain genera which were detected by the same sequencing methodology in pooled hospital sink trap samples, such as *Serratia*, *Azospira*, *Enterobacter*, *Glutamicibacter* and *Delftia* (Figure 2.2) were not detected in the university building sink trap community at all.

The 16S rDNA amplicon sequencing data indicate that even non-clinical sink traps, such as the university building sink traps studied here, contain a number of opportunistic pathogens. These key pathogens include *Citrobacter* spp., *Staphylococcus* spp., *Clostridioides* spp., and *Enterococcus* spp. However, the university building sink traps were dominated by primarily environmental (water/soil) organisms (Díaz-Cárdenas et al., 2017) such as *Desulfovibrio* and *Dethiosulfovibrio*. Human infections involving *Kluyvera* spp. have been described, although infrequently, suggesting the potential for *Kluyvera* spp. to emerge from

#### 5.4. DISCUSSION

---

environments such as water and soil to pose a threat to human health (Sarria et al., 2001).

These results once again highlight the effect of 16S rRNA gene variable region choice in amplicon surveys, and the potential differences in sink trap bacterial communities. It is not possible to say whether the differences between hospital sink trap and university building sink trap community composition, when investigated by the same sequencing methodology (Figure 2.2 versus Figure 5.8), are due to different environments, usage patterns, or selection conditions. Further molecular (culture-independent) work is needed to gain a more general view of the composition and dynamics of sink trap bacterial communities in clinical versus non-clinical environments.

One upcoming project, 'SinkBug' (<http://nitcollaborative.org.uk/wp/sinkbug/>), seeks to address this by investigating ARG and pathogen burden in sinks in UK hospitals and associations with HCAs, sink design, and sink usage. The multicentre prospective sampling study will recruit 30–40 participating sites to each sample 10 ward sink traps using a standardised protocol during a two-week sampling window. Samples will be subjected to 16S rDNA amplicon sequencing and a highly multiplexed PCR-based approach to identify ARGs termed 'AmpliSeq for Illumina Antimicrobial Resistance Research Panel'. The SinkBug project will provide a valuable large-scale dataset allowing comparison of data regarding the pathogen and ARG burden of sink traps with HCAI rates and resistance profiles. The data presented in this thesis contribute to a yet under-explored research area and provide an early indication of the results of 16S rDNA amplicon surveys of hospital and other buildings' sink traps, providing a foundation for future larger scale work.

## 5.5 Conclusion

In this chapter, the silver nanocoating previously tested *in vitro* against single-species bacterial inocula (Chapter 4) was challenged with multi-species hospital and university building sink trap communities *in vitro*, in a benchtop sink trap model, and placed in real-world university building sink traps for testing *in situ*. Results of *in vitro* assays were consistent with those of Chapter 4, with potent antibiofilm and antiplanktonic activity demonstrated. In the benchtop sink trap model seeded with a hospital sink trap community, significant antibiofilm activity was evident up to the 11 day time point but was no longer present at the 25 day time point. In real-world sink traps, antibiofilm activity was limited and inconsistent. It is proposed that the conditions of real-world sink traps, primarily the physical debris present, which was not a factor in *in vitro* assays, led to a blocking effect of the silver nanocoating limiting its antibacterial activity. The antibacterial efficacy of the silver nanocoating was specifically confirmed against the same real-world sink trap bacterial communities in follow-up *in vitro* studies. Characterisation of the microbial community in a non-clinical university building sink trap by 16S rDNA amplicon sequencing provided a point of comparison with data from hospital sink traps, however future larger-scale studies are needed to better characterise hospital sink traps in terms of their bacterial community and other relevant metrics such as antibiotic resistance gene content. The utility of ‘real-world’, *in situ* testing of novel antimicrobial surfaces was highlighted as these studies demonstrated differences in antibiofilm efficacy compared to laboratory-based *in vitro* studies.

## 5.5. CONCLUSION

---

## Chapter 6

# General discussion and conclusions

### 6.1 Contribution to knowledge

This project took previous work in the development of antimicrobial nanocoatings (Besinis, De Peralta and Handy, 2014a; Besinis et al., 2017; Meran et al., 2018; Gunpath et al., 2019, 2020) and sought to extend it for use on surfaces within wastewater plumbing systems, chiefly sink traps. Previous studies generally prepared antimicrobial nanocoatings consisting of silver, zinc oxide or hydroxyapatite nanoparticles applied to a substrate such as dentine, titanium, or silicone. These nanocoatings were found to exhibit potent antiplanktonic and antibiofilm activity against individual representative bacterial species in *in vitro* plate-based assays. To build upon this work, in this project, the silver nanocoating developed was based on pipe cement, a commercially-available and low-cost coating matrix which is already used in the plumbing industry. There are no other publications or products available which combine nanoparticles and pipe cement in this way. The developed silver nanocoating had potent antibacterial properties against relevant ESKAPE pathogens, both Gram positive and Gram-negative, as well as against different multispecies bacterial communities from hospital and university building sink traps when assessed *in vitro*. To further expand beyond previous work, novel approaches were developed to make later experiments more realistic, such as the use of a benchtop sink

trap model system and the placement of nanocoated specimens in real-world sink traps. These approaches complement and add to those employed by Kottay et al. (2017), Aranega-Bou et al. (2019), and Garratt et al. (2021). Other work completed investigated the bacteria present in hospital sink trap samples using culture-dependent and -independent techniques, adding to very few publications available employing 16S rDNA sequencing to characterise bacterial taxa in hospital WPS (Yano et al., 2017; Burgos-Garay et al., 2021). Information relating to the selection of primers for 16S rDNA sequencing of WPS will assist others and future work in optimising sequencing methodologies to improve resolution. A strain of an emerging pathogen which previously inhabited environmental niches, *Cupriavidus pauculus*, was isolated from a hospital sink trap and characterised in terms of its draft whole genome, antimicrobial susceptibility profile, biofilm formation, and *in vivo* median lethal dose in *Galleria mellonella* (Butler et al., 2022). This work presented the first *C. pauculus* strain isolated from a hospital sink trap, added to only 6 other genome assemblies available for this species, and was the first hybrid assembly incorporating ONT MinION long-reads, providing one of the best assemblies with respect to number of contigs. The strain was found to be multidrug-resistant, including resistant to colistin, and had a large number of metal resistance genes. These findings added to knowledge of emerging pathogens in hospital environments, drawing attention to the WPS as a potential transmission vehicle and reservoir for bacterial persistence, including multidrug-resistant bacteria which may themselves be overt pathogens or have the potential to transfer resistance to pathogens.

## 6.2 The future of antimicrobial nanocoating research

The global COVID-19 pandemic has attracted considerable attention towards infectious diseases both within and beyond the scientific community, leading to hopes of augmented funding programmes and better appreciation amongst the public for the ‘real-world’ implications of often abstract concepts such as AMR. Specifically, it is hoped that the COVID-19 pandemic has led to better appreciation for the role of surfaces in pathogen transmission and the potential impact of nosocomial transmission. The surfaces of medical implants and dental prostheses have become synonymous with development of antimicrobial nanocoatings due to the sheer weight of literature in those areas, but more ‘environmental’ surfaces are now being better targeted. These surfaces may include hospital high-touch surfaces such as bed rails, curtains, tables, doors, and fabrics such as patient gowns and medical scrubs as candidates for passive protection by the application of antimicrobial nanocoatings. If research on the development of antimicrobial nanocoatings for application to WPS is to continue and develop, there needs to be better appreciation of the role of WPS as a niche for bacterial persistence and vehicle for bacterial transmission. As well as potentially leading to further work to develop antimicrobial nanocoatings, this could also have the effect of improving the design of WPS and surveillance of the bacteria (or viruses and fungi) which inhabit them.

The findings of this PhD project indicate that future research endeavours within antimicrobial nanocoating development should always seek to employ realistic, preferably ‘real-world’ or ‘*in situ*’ testing wherever possible, as the performance of a nanocoating cannot be confidently known until this is completed. With this in mind, work not involving real-world testing should not extrapolate *in vitro* results too far beyond the conditions used when considering the potential impact



## *6.2. THE FUTURE OF ANTIMICROBIAL NANOCOATING RESEARCH*

---

of a novel antimicrobial surface. As ever, further research is needed to refine the technology and techniques, overcome the initial barriers to success, and potentially gain the attention of policymakers, investors, and funders.

## List of references

- Abbaszade, G., Szabó, A., Vajna, B., Farkas, R., Szabó, C. and Tóth, E. (2020), 'Whole genome sequence analysis of *Cupriavidus campinensis* S14E4C, a heavy metal resistant bacterium', *Molecular Biology Reports* **47**(5), 3973–3985.
- Agnihotri, S., Mukherji, S. and Mukherji, S. (2013), 'Immobilized silver nanoparticles enhance contact killing and show highest efficacy: elucidation of the mechanism of bactericidal action of silver', *Nanoscale* **5**(16), 7328–7340.
- Aithinne, K. A., Cooper, C. W., Lynch, R. A. and Johnson, D. L. (2019), 'Toilet plume aerosol generation rate and environmental contamination following bowl water inoculation with *Clostridium difficile* spores', *American Journal of Infection Control* **47**(5), 515–520.
- Akanksha, R., Yara, S., Sonal, C. K., Christopher, D., Saugat, P., Monk Jonathan, M., Palsson Bernhard, O. and Thomas, R. (2022), 'Pangenome Analytics Reveal Two-Component Systems as Conserved Targets in ESKAPEE Pathogens', *mSystems* **6**(1).
- Alexander, J. W. (2009), 'History of the Medical Use of Silver', *Surgical Infections* **10**(3), 289–292.
- Alfa, M. J., Dueck, C., Olson, N., Degagne, P., Papetti, S., Wald, A., Lo, E. and Harding, G. (2008), 'UV-visible marker confirms that environmental persistence of *Clostridium difficile* spores in toilets of patients with *C. difficile*

## LIST OF REFERENCES

---

- associated diarrhea is associated with lack of compliance with cleaning protocols', *BMC Infectious Diseases* **8**, 64.
- Alghoribi, M. F., Gibreel, T. M., Dodgson, A. R., Beatson, S. A. and Upton, M. (2014), '*Galleria mellonella* Infection Model Demonstrates High Lethality of ST69 and ST127 Uropathogenic *E. coli*', *PLOS ONE* **9**(7).
- Allaker, R. P. (2010), 'The use of nanoparticles to control oral biofilm formation', *Journal of Dental Research* **89**(11), 1175–1186.
- Almasy, E., Szederjesi, J., Rad, P. and Georgescu, A. (2016), 'A Fatal Case of Community Acquired *Cupriavidus pauculus* Pneumonia', *Journal of Critical Care Medicine* **2**(4), 201–204.
- Ambrose, P. G. (2005), 'Antimicrobial susceptibility breakpoints: PK-PD and susceptibility breakpoints.', *Treatments in Respiratory Medicine* **4**, 5–11.
- Ansari, J. M., Abraham, N. M., Massaro, J., Murphy, K., Smith-Carpenter, J. and Fikrig, E. (2017), 'Anti-Biofilm Activity of a Self-Aggregating Peptide against *Streptococcus mutans*', *Frontiers in Microbiology* **8**.
- Aquilini, E., Merino, S., Knirel, Y. A., Regué, M. and Tomás, J. M. (2014), 'Functional identification of *Proteus mirabilis* *eptC* gene encoding a core lipopolysaccharide phosphoethanolamine transferase.', *International Journal of Molecular Sciences* **15**, 6689–6702.
- Arakawa, H., Neault, J. F. and Tajmir-Riahi, H. A. (2001), 'Silver(I) Complexes with DNA and RNA Studied by Fourier Transform Infrared Spectroscopy and Capillary Electrophoresis', *Biophysical Journal* **81**(3), 1580–1587.
- Aranega-Bou, P., Ellaby, N., Ellington, M. J. and Moore, G. (2021), 'Migration of *Escherichia coli* and *Klebsiella pneumoniae* Carbapenemase (KPC)-

## LIST OF REFERENCES

---

- Producing *Enterobacter cloacae* through Wastewater Pipework and Establishment in Hospital Sink Waste Traps in a Laboratory Model System', *Microorganisms* **9**(9).
- Aranega-Bou, P., George, R. P., Verlander, N. Q., Paton, S., Bennett, A., Moore, G., Aiken, Z., Akinremi, O., Ali, A., Cawthorne, J., Cleary, P., Crook, D. W., Decraene, V., Dodgson, A., Doumith, M., Ellington, M., Eyre, D. W., George, R. P., Grimshaw, J., Guiver, M., Hill, R., Hopkins, K., Jones, R., Lenney, C., Mathers, A. J., McEwan, A., Moore, G., Neilson, M., Neilson, S., Peto, T. E. A., Phan, H. T. T., Regan, M., Seale, A. C., Stoesser, N., Turner-Gardner, J., Watts, V., Walker, J., Sarah Walker, A., Wyllie, D., Welfare, W. and Woodford, N. (2019), 'Carbapenem-resistant *Enterobacteriaceae* dispersal from sinks is linked to drain position and drainage rates in a laboratory model system.', *Journal of Hospital Infection* **102**(1), 63–69.
- Arijs, K., Nys, C., Van Sprang, P., De Schamphelaere, K. and Mertens, J. (2021), 'Setting a Protective Threshold Value for Silver Toward Freshwater Organisms.', *Environmental Toxicology and Chemistry* **40**, 1678–1693.
- Armitage, D. W., Gallagher, K. L., Youngblut, N. D., Buckley, D. H. and Zinder, S. H. (2012), 'Millimeter-scale patterns of phylogenetic and trait diversity in a salt marsh microbial mat', *Frontiers in Microbiology* **3**, 293.
- Ashkarran, A. A., Ghavami, M., Aghaverdi, H., Stroeve, P. and Mahmoudi, M. (2012), 'Bacterial effects and protein corona evaluations: crucial ignored factors in the prediction of bio-efficacy of various forms of silver nanoparticles.', *Chemical Research in Toxicology* **25**, 1231–42.
- Aslam, B., Khurshid, M., Arshad, M. I., Muzammil, S., Rasool, M., Yasmeen, N., Shah, T., Chaudhry, T. H., Rasool, M. H., Shahid, A., Xueshan, X. and

## LIST OF REFERENCES

---

- Baloch, Z. (2021), 'Antibiotic Resistance: One Health One World Outlook', *Frontiers in Cellular and Infection Microbiology* **11**.
- Asín-Prieto, E., Rodríguez-Gascón, A. and Isla, A. (2015), 'Applications of the pharmacokinetic/pharmacodynamic (PK/PD) analysis of antimicrobial agents', *Journal of Infection and Chemotherapy* **21**(5), 319–329.
- Ayliffe, G. A., Babb, J. R., Collins, B. J., Lowbury, E. J. and Newsom, S. W. (1974), '*Pseudomonas aeruginosa* in hospital sinks', *Lancet* **2**, 578–581.
- Badau, E. (2021), 'A One Health perspective on the issue of the antibiotic resistance.', *Parasite* **28**, 16.
- Baig, N., Kammakakam, I. and Falath, W. (2021), 'Nanomaterials: a review of synthesis methods, properties, recent progress, and challenges', *Advanced Materials* **2**, 1821–1871.
- Balada-Llasat, J.-M., Elkins, C., Swyers, L., Bannerman, T. and Pancholi, P. (2010), 'Pseudo-outbreak of *Cupriavidus pauculus* infection at an outpatient clinic related to rinsing culturette swabs in tap water', *Journal of Clinical Microbiology* **48**(7), 2645–2647.
- Bardossy, A. C., Zervos, J. and Zervos, M. (2016), 'Preventing hospital-acquired infections in low-income and middle-income countries: Impact, gaps, and opportunities.', *Infectious Disease Clinics of North America* **30**, 805–818.
- Barras, F., Aussel, L. and Ezraty, B. (2018), 'Silver and antibiotic, new facts to an old story', *Antibiotics* **7**(3), 79.
- Bayston, R., Mills, A., Howdle, S. M. and Ashraf, W. (2007), 'Comment on: The increasing use of silver-based products as antimicrobial agents: a useful de-

## LIST OF REFERENCES

---

- velopment or a cause for concern?', *Journal of Antimicrobial Chemotherapy* **60**(2), 447.
- Bellido, F., Martin, N. L., Siehnel, R. J. and Hancock, R. E. (1992), 'Reevaluation, using intact cells, of the exclusion limit and role of porin OprF in *Pseudomonas aeruginosa* outer membrane permeability', *Journal of Bacteriology* **174**(16), 5196–5203.
- Besinis, A., De Peralta, T. and Handy, R. D. (2014a), 'Inhibition of biofilm formation and antibacterial properties of a silver nano-coating on human dentine', *Nanotoxicology* **8**(7), 745–754.
- Besinis, A., De Peralta, T. and Handy, R. D. (2014b), 'The antibacterial effects of silver, titanium dioxide and silica dioxide nanoparticles compared to the dental disinfectant chlorhexidine on *Streptococcus mutans* using a suite of bioassays', *Nanotoxicology* **8**(1), 1–16.
- Besinis, A., De Peralta, T., Tredwin, C. J. and Handy, R. D. (2015), 'Review of nanomaterials in dentistry: interactions with the oral microenvironment, clinical applications, hazards, and benefits', *ACS Nano* **9**(3), 2255–2289.
- Besinis, A., Hadi, S. D., Le, H. R., Tredwin, C. and Handy, R. D. (2017), 'Antibacterial activity and biofilm inhibition by surface modified titanium alloy medical implants following application of silver, titanium dioxide and hydroxyapatite nanocoatings', *Nanotoxicology* **11**(3), 327–338.
- Besinis, A., van Noort, R. and Martin, N. (2012), 'Infiltration of demineralized dentin with silica and hydroxyapatite nanoparticles', *Dental Materials* **28**(9), 1012–1023.

## LIST OF REFERENCES

---

- Besinis, A., van Noort, R. and Martin, N. (2014), 'Remineralization potential of fully demineralized dentin infiltrated with silica and hydroxyapatite nanoparticles', *Dental Materials* **30**(3), 249–262.
- Besnard, V., Federighi, M., Declercq, E., Jugiau, F. and Cappelletti, J.-M. (2002), 'Environmental and physico-chemical factors induce VBNC state in *Listeria monocytogenes*', *Veterinary Research* **33**(4), 359–370.
- Bhagwat, G., O'Connor, W., Grainge, I. and Palanisami, T. (2021), 'Understanding the fundamental basis for biofilm formation on plastic surfaces: Role of conditioning films', *Frontiers in Microbiology* **12**.
- Bhatt, K., Timsit, E., Rawlyk, N., Potter, A. and Liljebjelke, K. (2018), 'Integrative Conjugative Element ICEHs1 Encodes for Antimicrobial Resistance and Metal Tolerance in *Histophilus somni*', *Frontiers in Veterinary Science* **5**.
- Bianco, G., Boattini, M., Audisio, E., Cavallo, R. and Costa, C. (2018), 'Septic shock due to meropenem- and colistin-resistant *Cupriavidus pauculus*', *Journal of Hospital Infection* **99**(3), 364–365.
- Bjerkkan, G., Witsø, E. and Bergh, K. (2009), 'Sonication is superior to scraping for retrieval of bacteria in biofilm on titanium and steel surfaces *in vitro*', *Acta orthopaedica* **80**(2), 245–250.
- Boers, S. A., Jansen, R. and Hays, J. P. (2019), 'Understanding and overcoming the pitfalls and biases of next-generation sequencing (NGS) methods for use in the routine clinical microbiological diagnostic laboratory', *European Journal of Clinical Microbiology and Infectious Diseases* **38**(6), 1059–1070.
- Bolger, A. M., Lohse, M. and Usadel, B. (2014), 'Trimmomatic: a flexible trimmer for Illumina sequence data', *Bioinformatics* **30**(15), 2114–2120.

## LIST OF REFERENCES

---

- Bos, R., van der Mei, H. C. and Busscher, H. J. (1999), 'Physico-chemistry of initial microbial adhesive interactions—its mechanisms and methods for study', *FEMS Microbiology Reviews* **23**, 179–230.
- Breidenstein, E. B. M., de la Fuente-Núñez, C. and Hancock, R. E. W. (2011), 'Pseudomonas aeruginosa: all roads lead to resistance.', *Trends in Microbiology* **19**, 419–426.
- Breitwieser, F. P. and Salzberg, S. L. (2016), 'Pavian: Interactive analysis of metagenomic data for microbiomics and pathogen identification', *bioRxiv* .
- Brettin, T., Davis, J. J., Disz, T., Edwards, R. A., Gerdes, S., Olsen, G. J., Olson, R., Overbeek, R., Parrello, B., Pusch, G. D., Shukla, M., Thomason, J. A., r., Stevens, R., Vonstein, V., Wattam, A. R. and Xia, F. (2015), 'RASTtk: a modular and extensible implementation of the RAST algorithm for building custom annotation pipelines and annotating batches of genomes', *Scientific Reports* **5**, 8365.
- Bridier, A., Briandet, R., Thomas, V. and Dubois-Brissonnet, F. (2011), 'Resistance of bacterial biofilms to disinfectants: a review', *Biofouling* **27**(9), 1017–1032.
- Brinton, C. C. (1959), 'Non-flagellar appendages of bacteria', *Nature* **183**, 782–786.
- Brooke, J. S. (2012), 'Stenotrophomonas maltophilia: an emerging global opportunistic pathogen', *Clinical Microbiology Reviews* **25**, 2–41.
- Brooks, J. P., Edwards, D. J., Harwich, M. D., Rivera, M. C., Fettweis, J. M., Serrano, M. G., Reris, R. A., Sheth, N. U., Huang, B., Girerd, P., Strauss, J. F., Jefferson, K. K. and Buck, G. A. (2015), 'The truth about metagenomics:



## LIST OF REFERENCES

---

- quantifying and counteracting bias in 16S rRNA studies', *BMC Microbiology* **15**(1), 66.
- Burgos-Garay, M., Ganim, C., de Man, T. J. B., Davy, T., Mathers, A. J., Kotay, S., Daniels, J., Perry, K. A., Breaker, E. and Donlan, R. M. (2021), 'Colonization of carbapenem-resistant *Klebsiella pneumoniae* in a sink-drain model biofilm system', *Infection Control and Hospital Epidemiology* **42**(6), 722–730.
- Burnham, J. P., Olsen, M. A. and Kollef, M. H. (2018), 'Re-estimating annual deaths due to multidrug-resistant organism infections', *Infection Control & Hospital Epidemiology* pp. 1–2.
- Butler, J., Kelly, S. D., Muddiman, K. J., Besinis, A. and Upton, M. (2022), 'Hospital sink traps as a potential source of the emerging multidrug-resistant pathogen *Cupriavidus pauculus*: characterization and draft genome sequence of strain MF1', *Journal of Medical Microbiology* **71**(2).
- Byappanahalli Muruleedhara, N., Nevers Meredith, B., Asja, K., Staley Zachery, R. and Harwood Valerie, J. (2012), 'Enterococci in the environment', *Microbiology and Molecular Biology Reviews* **76**(4), 685–706.
- Caporaso, J. G., Lauber, C. L., Walters, W. A., Berg-Lyons, D., Lozupone, C. A., Turnbaugh, P. J., Fierer, N. and Knight, R. (2011), 'Global patterns of 16S rRNA diversity at a depth of millions of sequences per sample', *PNAS* **108**, 4516–4522.
- Cardona, S., Eck, A., Cassellas, M., Gallart, M., Alastrue, C., Dore, J., Azpiroz, F., Roca, J., Guarner, F. and Manichanh, C. (2012), 'Storage conditions of intestinal microbiota matter in metagenomic analysis', *BMC Microbiology* **12**, 158.

## LIST OF REFERENCES

---

- Cassini, A., Hogberg, L. D., Plachouras, D., Quattrocchi, A., Hoxha, A. and Simonsen, G. S. (2018), 'Attributable deaths and disability-adjusted life-years caused by infections with antibiotic-resistant bacteria in the EU and the European Economic Area in 2015: a population-level modelling analysis', *The Lancet Infectious Diseases* .
- CDC (2004), 'Acinetobacter baumannii infections among patients at military medical facilities treating injured U.S. service members, 2002-2004.', *Morbidity and Mortality Weekly Report* **53**, 1063–1066.
- CDC (2013), 'Antibiotic Resistance threats in the United States'.
- Chahales, P. and Thanassi, D. G. (2015), 'Structure, function, and assembly of adhesive organelles by uropathogenic bacteria', *Microbiology Spectrum* **3**.
- Chakravorty, S., Helb, D., Burday, M., Connell, N. and Alland, D. (2007), 'A detailed analysis of 16S ribosomal RNA gene segments for the diagnosis of pathogenic bacteria', *Journal of Microbiological Methods* **69**, 330–339.
- Chan, A. W., Naphtali, J. and Schellhorn, H. E. (2019), 'High-throughput DNA sequencing technologies for water and wastewater analysis', *Science Progress* **102**(4), 351–376.
- Chandler, D. P., Fredrickson, J. K. and Brockman, F. J. (1997), 'Effect of PCR template concentration on the composition and distribution of total community 16S rDNA clone libraries.', *Molecular Ecology* **6**, 475–482.
- Chawla, R., Gupta, R., Lele, T. P. and Lele, P. P. (2020), 'A Skeptic's Guide to Bacterial Mechanosensing', *Journal of Molecular Biology* **432**, 523–533.
- Chemnitzer, R. (2019), 'Strategies for Achieving the Lowest Possible Detec-

## LIST OF REFERENCES

---

- tion Limits in ICP-MS: Strategies for Achieving the Lowest Possible Detection Limits in ICP-MS', *Spectroscopy* **34**(10), 12–16.
- Chen, C., Song, X., Wei, W., Zhong, H., Dai, J., Lan, Z., Li, F., Yu, X., Feng, Q., Wang, Z., Xie, H., Chen, X., Zeng, C., Wen, B., Zeng, L., Du, H., Tang, H., Xu, C., Xia, Y., Xia, H., Yang, H., Wang, J., Wang, J., Madsen, L., Brix, S., Kristiansen, K., Xu, X., Li, J., Wu, R. and Jia, H. (2017), 'The microbiota continuum along the female reproductive tract and its relation to uterine-related diseases', *Nature Communications* **8**(1), 875.
- Chen, J. L., Steele, T. W. J. and Stuckey, D. C. (2018), 'Metabolic reduction of resazurin; location within the cell for cytotoxicity assays.', *Biotechnology and Bioengineering* **115**, 351–358.
- Chen, N., Zhou, M., Dong, X., Qu, J., Gong, F., Han, Y., Qiu, Y., Wang, J., Liu, Y., Wei, Y., Xia, J., Yu, T., Zhang, X. and Zhang, L. (2020), 'Epidemiological and clinical characteristics of 99 cases of 2019 novel coronavirus pneumonia in Wuhan, China: a descriptive study', *Lancet* **395**, 507–513.
- Chen, S., Li, X., Wang, Y., Zeng, J., Ye, C., Li, X., Guo, L., Zhang, S. and Yu, X. (2018), 'Induction of *Escherichia coli* into a VBNC state through chlorination/chloramination and differences in characteristics of the bacterium between states', *Water Research* **142**, 279–288.
- Chen, Z., Guo, J., Jiang, Y. and Shao, Y. (2021), 'High concentration and high dose of disinfectants and antibiotics used during the COVID-19 pandemic threaten human health', *Environmental Sciences Europe* **33**, 11.
- Choi, B. K., Wyss, C. and Göbel, U. B. (1996), 'Phylogenetic analysis of pathogen-related oral spirochetes.', *Journal of Clinical Microbiology* **34**, 1922–1925.

## LIST OF REFERENCES

---

- Chopra, I. (2007), 'The increasing use of silver-based products as antimicrobial agents: a useful development or a cause for concern?', *Journal of Antimicrobial Chemotherapy* **59**, 587–590.
- Ciofu, O. and Tolker-Nielsen, T. (2019), 'Tolerance and Resistance of *Pseudomonas aeruginosa* Biofilms to Antimicrobial Agents—How *P. aeruginosa* Can Escape Antibiotics', *Frontiers in Microbiology* **10**(913).
- Clarridge, J. E. r. (2004), 'Impact of 16S rRNA gene sequence analysis for identification of bacteria on clinical microbiology and infectious diseases.', *Clinical Microbiology Reviews* **17**, 840–862.
- Codjoe, F. S. and Donkor, E. S. (2017), 'Carbapenem Resistance: A Review', *Medical Sciences* **6**, 1.
- Coll, F., Harrison, E. M., Toleman, M. S., Reuter, S., Raven, K. E., Blane, B., Palmer, B., Kappeler, A. R. M., Brown, N. M., Török, M. E., Parkhill, J. and Peacock, S. J. (2017), 'Longitudinal genomic surveillance of MRSA in the UK reveals transmission patterns in hospitals and the community', *Science Translational Medicine* **9**(413).
- Comber, S. D. W., Upton, M., Lewin, S., Powell, N. and Hutchinson, T. H. (2020), 'COVID-19, antibiotics and One Health: a UK environmental risk assessment', *Journal of Antimicrobial Chemotherapy* **75**(11), 3411–3412.
- Connor, T. R., Loman, N. J., Thompson, S., Smith, A., Southgate, J., Poplawski, R., Bull, M. J., Richardson, E., Ismail, M., Thompson, S. E., Kitchen, C., Guest, M., Bakke, M., Sheppard, S. K. and Pallen, M. J. (2016), 'CLIMB (the Cloud Infrastructure for Microbial Bioinformatics): an online resource for the medical microbiology community', *Microbial Genomics* **2**(9).

## LIST OF REFERENCES

---

- Cook, K. and Bolster, C. (2007), 'Survival of *Campylobacter jejuni* and *Escherichia coli* in groundwater during prolonged starvation at low temperatures', *Journal of Applied Microbiology* **103**(3), 573–583.
- Costerton, J. W., Geesey, G. G. and Cheng, K. J. (1978), 'How bacteria stick', *Scientific American* **238**(1), 86–95.
- Courtois, P., Rorat, A., Lemiere, S., Guyoneaud, R., Attard, E., Levard, C. and Vandebulcke, F. (2019), 'Ecotoxicology of silver nanoparticles and their derivatives introduced in soil with or without sewage sludge: A review of effects on microorganisms, plants and animals', *Environmental Pollution* **253**, 578–598.
- Crabbé, A., Jensen, P. O., Bjarnsholt, T. and Coenye, T. (2019), 'Antimicrobial tolerance and metabolic adaptations in microbial biofilms', *Trends in Microbiology* **27**(10), 850–863.
- Crawford, R. J., Webb, H. K., Truong, V. K., Hasan, J. and Ivanova, E. P. (2012), 'Surface topographical factors influencing bacterial attachment.', *Advances in Colloid and Interface Science* pp. 142–149.
- Crusz, S. A., Popat, R., Rybtke, M. T., Cámara, M., Givskov, M., Tolker-Nielsen, T., Diggle, S. P. and Williams, P. (2012), 'Bursting the bubble on bacterial biofilms: a flow cell methodology', *Biofouling* **28**, 835–842.
- Cunha, C. B. and Opal, S. M. (2018), 'Antibiotic stewardship: Strategies to minimize antibiotic resistance while maximizing antibiotic effectiveness.', *The Medical Clinics of North America* **102**, 831–843.
- Dai, D., Wang, H., Xu, X., Chen, C., Song, C., Jiang, D., Du, P., Zhang, Y. and Zeng, H. (2018), 'The emergence of multi-resistant *Enterococcus faecalis*

## LIST OF REFERENCES

---

- clonal complex, CC4, causing nosocomial infections', *Journal of Medical Microbiology* **67**(8), 1069–1077.
- Dancer, S. J. (1999), 'Mopping up hospital infection.', *Journal of Hospital Infection* **43**, 85–100.
- Dancer, S. J. (2011), 'Hospital cleaning in the 21st century.', *European Journal of Clinical Microbiology & Infectious Diseases* **30**, 1473–1481.
- Dancer, S. J. (2014), 'Controlling hospital-acquired infection: focus on the role of the environment and new technologies for decontamination', *Clinical Microbiology Reviews* **27**, 665–690.
- David, S., Reuter, S., Harris, S. R., Glasner, C., Feltwell, T. and Argimon, S. (2019), 'Epidemic of carbapenem-resistant *Klebsiella pneumoniae* in Europe is driven by nosocomial spread', *Nature Microbiology* .
- Davies, D. (2003), 'Understanding biofilm resistance to antibacterial agents', *Nature Reviews Drug Discovery* **2**(2), 114–122.
- Davis, J. J., Wattam, A. R., Aziz, R. K., Brettin, T., Butler, R., Butler, R. M., Chlenski, P., Conrad, N., Dickerman, A., Dietrich, E. M., Gabbard, J. L., Gerdes, S., Guard, A., Kenyon, R. W., Machi, D., Mao, C., Murphy-Olson, D., Nguyen, M., Nordberg, E. K., Olsen, G. J., Olson, R. D., Overbeek, J. C., Overbeek, R., Parrello, B., Pusch, G. D., Shukla, M., Thomas, C., VanOeffelen, M., Vonstein, V., Warren, A. S., Xia, F., Xie, D., Yoo, H. and Stevens, R. (2019), 'The PATRIC Bioinformatics Resource Center: expanding data and analysis capabilities', *Nucleic Acids Research* **48**, 606–612.
- Davis, K. A., Moran, K. A., McAllister, C. K. and Gray, P. J. (2005), 'Multidrug-

## LIST OF REFERENCES

---

- resistant *Acinetobacter* extremity infections in soldiers', *Emerging Infectious Diseases* **11**, 1218–1224.
- de Abreu, P. M., Farias, P. G., Paiva, G. S., Almeida, A. M. and Morais, P. V. (2014), 'Persistence of microbial communities including *Pseudomonas aeruginosa* in a hospital environment: a potential health hazard', *BMC Microbiology* **14**(1), 118.
- De Beer, D., Srinivasan, R. and Stewart, P. S. (1994), 'Direct measurement of chlorine penetration into biofilms during disinfection', *Applied and Environmental Microbiology* **60**, 4339–4344.
- De Coster, W., D'Hert, S., Schultz, D. T., Cruts, M. and Van Broeckhoven, C. (2018), 'Nanopack: visualizing and processing long-read sequencing data', *Bioinformatics* **34**(15), 2666–2669.
- De Geyter, D., Blommaert, L., Verbraeken, N., Sevenois, M., Huyghens, L., Martini, H., Covens, L., Piérard, D. and Wybo, I. (2017), 'The sink as a potential source of transmission of carbapenemase-producing *Enterobacteriaceae* in the intensive care unit', *Antimicrobial Resistance & Infection Control* **6**(1), 24.
- De Geyter, D., Vanstokstraeten, R., Crombé, F., Tommassen, J., Wybo, I. and Piérard, D. (2021), 'Sink drains as reservoirs of VIM-2 metallo-beta-lactamase-producing *Pseudomonas aeruginosa* in a Belgian intensive care unit: relation to patients investigated by whole-genome sequencing', *Journal of Hospital Infection* **115**, 75–82.
- De Jonge, E., de Boer, M. G. J., van Essen, E. H. R., Dogterom-Ballering, H. C. M. and Veldkamp, K. E. (2019), 'Effects of a disinfection device on colo-

## LIST OF REFERENCES

---

- nization of sink drains and patients during a prolonged outbreak of multidrug-resistant *Pseudomonas aeruginosa* in an intensive care unit', *Journal of Hospital Infection* **102**(1), 70–74.
- De Kraker, M. E. A., Stewardson, A. J. and Harbarth, S. (2016), 'Will 10 Million People Die a Year due to Antimicrobial Resistance by 2050?', *PLOS Medicine* **13**(11), 1–6.
- Decraene, V., Phan, H. T. T., George, R., Wyllie, D. H., Akinremi, O., Aiken, Z., Cleary, P., Dodgson, A., Pankhurst, L., Crook, D. W., Lenney, C., Walker, A. S., Woodford, N., Sebra, R., Fath-Ordoubadi, F., Mathers, A. J., Seale, A. C., Guiver, M., McEwan, A., Watts, V., Welfare, W., Stoesser, N., Cawthorne, J. and Group, T. I. (2018), 'A Large, Refractory Nosocomial Outbreak of *Klebsiella pneumoniae* Carbapenemase-Producing *Escherichia coli* Demonstrates Carbapenemase Gene Outbreaks Involving Sink Sites', *Antimicrobial Agents and Chemotherapy* **62**(12), 1–12.
- Delaney, M. B. (2017), 'Kick the Bucket: One Hospital System's Journey to Reduce *Clostridium Difficile*', *Journal of Emergency Nursing* **43**, 519–525.
- Delmar, J. A., Su, C.-C. and Yu, E. W. (2013), 'Structural mechanisms of heavy-metal extrusion by the Cus efflux system', *Biometals* **26**(4), 593–607.
- Department of Health (2016), 'Health Technical Memorandum 04-01: Safe water in healthcare premises'. Part A: Design, installation and commissioning.
- Desai, N. and Ardekani, A. M. (2020), 'Biofilms at interfaces: microbial distribution in floating films', *Soft Matter* **16**, 1731–1750.
- Dibrov, P., Dzioba, J., Gosink, K. K. and Hanse, C. C. (2002), 'Chemiosmotic



## LIST OF REFERENCES

---

- Mechanism of Antimicrobial Activity of Ag<sup>+</sup> in *Vibrio cholerae*', *Antimicrobial Agents and Chemotherapy* **46**(8), 2668–2670.
- Diggle, S. P. and Whiteley, M. (2020), 'Microbe profile: *Pseudomonas aeruginosa*: opportunistic pathogen and lab rat', *Microbiology* **166**(1), 30–33.
- Dijkshoorn, L., Nemec, A. and Seifert, H. (2007), 'An increasing threat in hospitals: multidrug-resistant *Acinetobacter baumannii*', *Nature Reviews Microbiology* **5**, 939–951.
- Donlan, R. M. (2002), 'Biofilms: Microbial life on surfaces', *Emerging Infectious Diseases* **8**(9), 881–890.
- Dreier, J. and Ruggerone, P. (2015), 'Interaction of antibacterial compounds with RND efflux pumps in *Pseudomonas aeruginosa*', *Frontiers in Microbiology* **6**.
- Ducret, A., Chabalier, M. and Dukan, S. (2014), 'Characterization and resuscitation of 'non-culturable' cells of *Legionella pneumophila*', *BMC Microbiology* **14**(1), 3.
- Duggal, S., Gur, R., Nayar, R., Rongpharpi, S. R., Jain, D. and Gupta, R. K. (2013), '*Cupriavidus pauculus* (*Ralstonia paucula*) concomitant meningitis and septicemia in a neonate: First case report from India', *Indian Journal of Medical Microbiology* **31**(4), 405–409.
- Duguid, J. P., Smith, I. W., Dempster, G. and Edmunds, P. N. (1955), 'Non-flagellar filamentous appendages (fimbriae) and haemagglutinating activity in *Bacterium coli*', *Journal of Pathology and Bacteriology* **70**, 335–348.
- Dupont, P., Hocquet, D., Jeannot, K., Chavanet, P. and Plésiat, P. (2005), 'Bacteriostatic and bactericidal activities of eight fluoroquinolones against

## LIST OF REFERENCES

---

- MexAB-OprM-overproducing clinical strains of *Pseudomonas aeruginosa*', *Journal of Antimicrobial Chemotherapy* **55**(4), 518–522.
- Dyer, C., Hutt, L. P., Burky, R. and Joshi, L. T. (2019), 'Biocide Resistance and Transmission of *Clostridium difficile* Spores Spiked onto Clinical Surfaces from an American Health Care Facility', *Applied and Environmental Microbiology* **85**(17).
- Díaz-Cárdenas, C., López, G., Alzate-Ocampo, J. D., González, L. N., Shapiro, N., Woyke, T., Kyrpides, N. C., Restrepo, S. and Baena, S. (2017), 'Draft genome sequence of *Dethiosulfovibrio salsuginis* DSM 21565T an anaerobic, slightly halophilic bacterium isolated from a Colombian saline spring', *Standards in Genomic Sciences* **12**(1), 86.
- Döring, G., Ulrich, M., Müller, W., Bitzer, J., Schmidt-Koenig, L., Müntz, L., Grupp, H., Wolz, C., Stern, M. and Botzenhart, K. (1991), 'Generation of *Pseudomonas aeruginosa* aerosols during handwashing from contaminated sink drains, transmission to hands of hospital personnel, and its prevention by use of a new heating device', *International Journal of Hygiene and Environmental Medicine* **191**(5), 494–505.
- D'Inzeo, T., Santangelo, R., Fiori, B., De Angelis, G., Conte, V., Giaquinto, A., Palucci, I., Scoppettuolo, G., Di Florio, V., Giani, T., Sanguinetti, M., Rossolini, G. M. and Spanu, T. (2015), 'Catheter-related bacteremia by *Cupriavidus metallidurans*', *Diagnostic Microbiology and Infectious Disease* **81**(1), 9–12.
- Edwardson, C. F. and Hollibaugh, J. T. (2018), 'Composition and Activity of Microbial Communities along the Redox Gradient of an Alkaline, Hypersaline, Lake', *Frontiers in Microbiology* **9**, 14.

## LIST OF REFERENCES

---

- Elias, S. and Banin, E. (2012), 'Multi-species biofilms: living with friendly neighbors', *FEMS Microbiology Reviews* **36**(5), 990–1004.
- Fabrega, J., Luoma, S. N., Tyler, C. R., Galloway, T. S. and Lead, J. R. (2011), 'Silver nanoparticles: behaviour and effects in the aquatic environment.', *Environment International* **37**, 517–531.
- Fadeev, E., Cardozo-Mino, M. G., Rapp, J. Z., Bienhold, C., Salter, I., Salman-Carvalho, V., Molari, M., Tegetmeyer, H. E., Buttigieg, P. L. and Boetius, A. (2021), 'Comparison of Two 16S rRNA Primers (V3–V4 and V4–V5) for Studies of Arctic Microbial Communities', *Frontiers in Microbiology* **12**.
- Falagas, M. E., Karveli, E. A., Kelesidis, I. and Kelesidis, T. (2007), 'Community-acquired *Acinetobacter* infections', *European Journal of Clinical Microbiology and Infectious Diseases* **26**(12), 857–868.
- Falagas, M. E. and Kasiakou, S. K. (2005), 'Colistin: the revival of polymyxins for the management of multidrug-resistant gram-negative bacterial infections.', *Clinical Infectious Diseases* **40**, 1333–41.
- Federici, G., Shaw, B. J. and Handy, R. D. (2007), 'Toxicity of titanium dioxide nanoparticles to rainbow trout (*Oncorhynchus mykiss*): Gill injury, oxidative stress, and other physiological effects', *Aquatic Toxicology* **84**(4), 415–430.
- Feng, T., Kim, K. H., Oh, J. and Jeon, C. O. (2019), '*Cupriavidus lacunae* sp. nov., isolated from pond-side soil', *Antonie Van Leeuwenhoek* **112**(4), 543–551.
- Finken, M., Kirschner, P., Meier, A., Wrede, A. and Böttger, E. C. (1993), 'Molecular basis of streptomycin resistance in *Mycobacterium tuberculosis*: alterations of the ribosomal protein S12 gene and point mutations within a func-

## LIST OF REFERENCES

---

- tional 16S ribosomal RNA pseudoknot', *Molecular Microbiology* **9**(6), 1239–1246.
- Flemming, H.-C. and Wingender, J. (2010), 'The biofilm matrix', *Nature Reviews Microbiology* **8**, 623.
- Flemming, H.-C., Wingender, J., Szewzyk, U., Steinberg, P., Rice, S. A. and Kjelleberg, S. (2016), 'Biofilms: an emergent form of bacterial life', *Nature Reviews Microbiology* **14**, 563.
- Fogarty, L., Haack, S., Wolcott, M. and Whitman, R. (2003), 'Abundance and characteristics of the recreational water quality indicator bacteria *Escherichia coli* and enterococci in gull faeces', *Journal of Applied Microbiology* **94**(5), 865–878.
- Francius, G., El Zein, R., Mathieu, L., Gosselin, F., Maul, A. and Block, J.-C. (2017), 'Nano-exploration of organic conditioning film formed on polymeric surfaces exposed to drinking water', *Water Research* **109**, 155–163.
- Franco, L. C., Tanner, W., Ganim, C., Davy, T., Edwards, J. and Donlan, R. (2020), 'A microbiological survey of handwashing sinks in the hospital built environment reveals differences in patient room and healthcare personnel sinks', *Scientific Reports* **10**, 8234.
- Frank, J. A., Reich, C. I., Sharma, S., Weisbaum, J. S., Wilson, B. A. and Olsen, G. J. (2008), 'Critical evaluation of two primers commonly used for amplification of bacterial 16S rRNA genes', *Applied and Environmental Microbiology* **74**, 2461–2470.
- Frevert, U. (2004), 'Sneaking in through the back entrance: the biology of malaria liver stages.', *Trends in Parasitology* **20**, 417–424.

## LIST OF REFERENCES

---

- Friedlander, R. S., Vlamakis, H., Kim, P., Khan, M., Kolter, R. and Aizenberg, J. (2013), 'Bacterial flagella explore microscale hummocks and hollows to increase adhesion', *PNAS* **110**(14), 5624–5629.
- Fujioka, R., Sian-Denton, C., Borja, M., Castro, J. and Morpew, K. (1998), 'Soil: the environmental source of *Escherichia coli* and Enterococci in Guam's streams', *Journal of Applied Microbiology* **85**, 83–89.
- Fuks, G., Elgart, M., Amir, A., Zeisel, A., Turnbaugh, P. J., Soen, Y. and Shental, N. (2018), 'Combining 16S rRNA gene variable regions enables high-resolution microbial community profiling', *Microbiome* **6**(1), 17.
- Fuqua, W. C., Winans, S. C. and Greenberg, E. P. (1994), 'Quorum sensing in bacteria: the LuxR-LuxI family of cell density-responsive transcriptional regulators', *Journal of Bacteriology* **176**(2), 269–275.
- Fusch, C., Pogorzelski, D., Main, C., Meyer, C.-L., El Helou, S. and Mertz, D. (2015), 'Self-disinfecting sink drains reduce the *Pseudomonas aeruginosa* bioburden in a neonatal intensive care unit.', *Acta paediatrica* **104**, e344–9.
- Féria, C., Ferreira, E., Correia, J. D., Goncalves, J. and Canica, M. (2002), 'Patterns and mechanisms of resistance to  $\beta$ -lactams and  $\beta$ -lactamase inhibitors in uropathogenic *Escherichia coli* isolated from dogs in Portugal', *Journal of Antimicrobial Chemotherapy* **49**(1), 77–85.
- Garner, J. S., Jarvis, W. R., Emori, T., Horan, T. C. and Hughes, J. M. (1988), 'CDC definitions for nosocomial infections, 1988', *American Journal of Infection Control* **16**(3), 128–140.
- Garratt, I., Aranega-Bou, P., Sutton, J. M., Moore, G., Wand, M. E. and McBain, A. J. (2021), 'Long-Term Exposure to Octenidine in a Simulated Sink Trap

## LIST OF REFERENCES

---

- Environment Results in Selection of *Pseudomonas aeruginosa*, *Citrobacter*, and *Enterobacter* Isolates with Mutations in Efflux Pump Regulators', *Applied and Environmental Microbiology* **87**(10), 210–221.
- Gill, C., van de Wijgert, J. H. H. M., Blow, F. and Darby, A. C. (2016), 'Evaluation of Lysis Methods for the Extraction of Bacterial DNA for Analysis of the Vaginal Microbiota.', *PLOS ONE* **11**.
- Gordon, V. D. and Wang, L. (2019), 'Bacterial mechanosensing: the force will be with you, always', *Journal of Cell Science* **132**.
- Goris, J., Konstantinidis, K. T., Klappenbach, J. A., Coenye, T., Vandamme, P. and Tiedje, J. M. (2007), 'DNA-DNA hybridization values and their relationship to whole-genome sequence similarities', *International Journal of Systematic and Evolutionary Microbiology* **57**(1), 81–91.
- Gormley, M., Aspray, T. J., Kelly, D. A. and Rodriguez-Gil, C. (2017), 'Pathogen cross-transmission via building sanitary plumbing systems in a full scale pilot test-rig', *PLOS ONE* **12**(2).
- Gottschalk, F., Sonderer, T., Scholz, R. W. and Nowack, B. (2009), 'Modeled Environmental Concentrations of Engineered Nanomaterials (TiO<sub>2</sub>, ZnO, Ag, CNT, Fullerenes) for Different Regions', *Environmental Science & Technology* **43**(24), 9216–9222.
- Grabowski, M., Lobo, J. M., Gunnell, B., Enfield, K., Carpenter, R., Barnes, L. and Mathers, A. J. (2018), 'Characterizations of handwashing sink activities in a single hospital medical intensive care unit', *Journal of Hospital Infection* **100**(3), 115–122.

## LIST OF REFERENCES

---

- Graham, L. L. and Feero, S. E. (2019), 'The *Campylobacter fetus* S layer provides resistance to photoactivated zinc oxide nanoparticles', *Canadian Journal of Microbiology* **65**, 450–460.
- Guest, J. F., Keating, T., Gould, D. and Wigglesworth, N. (2020), 'Modelling the annual NHS costs and outcomes attributable to healthcare-associated infections in England', *BMJ Open* **10**(1).
- Gunawan, C., Marquis, C. P., Amal, R., Sotiriou, G. A., Rice, S. A. and Harry, E. J. (2017), 'Widespread and indiscriminate nanosilver use: Genuine potential for microbial resistance', *ACS Nano* **11**(4), 3438–3445.
- Gunputh, U. F., Le, H., Besinis, A., Tredwin, C. and Handy, R. D. (2019), 'Multi-layered composite coatings of titanium dioxide nanotubes decorated with zinc oxide and hydroxyapatite nanoparticles: controlled release of Zn and antimicrobial properties against *Staphylococcus aureus*', *International Journal of Nanomedicine* **14**, 3583–3600.
- Gunputh, U. F., Le, H., Lawton, K., Besinis, A., Tredwin, C. and Handy, R. D. (2020), 'Antibacterial properties of silver nanoparticles grown *in situ* and anchored to titanium dioxide nanotubes on titanium implant against *Staphylococcus aureus*', *Nanotoxicology* **14**(1), 97–110.
- Halstead, F. D., Quick, J., Niebel, M., Garvey, M., Cumley, N., Smith, R., Neal, T., Roberts, P., Hardy, K., Shabir, S., Walker, J. T., Hawkey, P. and Loman, N. J. (2021), '*Pseudomonas aeruginosa* infection in augmented care: the molecular ecology and transmission dynamics in four large uk hospitals', *Journal of Hospital Infection* **111**, 162–168.
- Hancock, R. E. W. and Brinkman, F. S. L. (2002), 'Function of *Pseudomonas* Porins in Uptake and Efflux', *Annual Review of Microbiology* **56**(1), 17–38.

## LIST OF REFERENCES

---

- Handy, R. D., Eddy, F. B. and Romain, G. (1989), 'In vitro evidence for the ionoregulatory role of rainbow trout mucus in acid, acid/aluminium and zinc toxicity', *Journal of Fish Biology* **35**(5), 737–747.
- Hang, J., Desai, V., Zavaljevski, N., Yang, Y., Lin, X., Satya, R. V., Martinez, L. J., Blaylock, J. M., Jarman, R. G., Thomas, S. J. and Kuschner, R. A. (2014), '16S rRNA gene pyrosequencing of reference and clinical samples and investigation of the temperature stability of microbiome profiles', *Microbiome* **2**(1), 31.
- Hansen, M. C., Tolker-Nielsen, T., Givskov, M. and Molin, S. (1998), 'Biased 16S rDNA PCR amplification caused by interference from DNA flanking the template region', *FEMS Microbiology Ecology* **26**(2), 141–149.
- Haque, M., Sartelli, M., McKimm, J. and Abu Bakar, M. (2018), 'Health care-associated infections - an overview', *Infection and Drug Resistance* **11**, 2321–2333.
- Harding, C. M., Hennon, S. W. and Feldman, M. F. (2018), 'Uncovering the mechanisms of *Acinetobacter baumannii* virulence.', *Nature Reviews Microbiology* **16**, 91–102.
- Hauser, A. R., Jain, M., Bar-Meir, M. and McColley, S. A. (2011), 'Clinical Significance of Microbial Infection and Adaptation in Cystic Fibrosis', *Clinical Microbiology Reviews* **24**(1), 29–70.
- Heidelberg, J. F., Shahamat, M., Levin, M., Rahman, I., Stelma, G., Grim, C. and Colwell, R. R. (1997), 'Effect of aerosolization on culturability and viability of Gram-negative bacteria', *Applied and Environmental Microbiology* **63**(9), 3585–3588.



## LIST OF REFERENCES

---

- Helmlinger, J., Sengstock, C., Groß-Heitfeld, C., Mayer, C., Schildhauer, T. A., Köller, M. and Eppler, M. (2016), 'Silver nanoparticles with different size and shape: equal cytotoxicity, but different antibacterial effects', *RSC Advances* **6**, 18490–18501.
- Hengzhuang, W., Wu, H., Ciofu, O., Song, Z. and Høiby, N. (2012), 'In vivo pharmacokinetics/pharmacodynamics of colistin and imipenem in *Pseudomonas aeruginosa* biofilm infection', *Antimicrobial Agents and Chemotherapy* **56**(5), 2683–2690.
- Henriques, P. C., Borges, I., Pinto, A. M., Magalhaes, F. D. and Goncalves, I. C. (2018), 'Fabrication and antimicrobial performance of surfaces integrating graphene-based materials', *Carbon* **132**, 709–732.
- Hermansson, M. (1999), 'The DLVO theory in microbial adhesion', *Colloids and Surfaces B: Biointerfaces* **14**(1), 105–119.
- Hernández-González, I. L., Mateo-Estrada, V. and Castillo-Ramirez, S. (2022), 'The promiscuous and highly mobile resistome of *Acinetobacter baumannii*', *Microbial Genomics* **8**(1).
- Hesketh-Best, P. J., Mouritzen, M. V., Shandley-Edwards, K., Billington, R. A. and Upton, M. (2021), '*Galleria mellonella* larvae exhibit a weight-dependent lethal median dose when infected with methicillin-resistant *Staphylococcus aureus*', *Pathogens and Disease* **79**(2).
- Hiergeist, A., Reischl, U. and Gessner, A. (2016), 'Multicenter quality assessment of 16S ribosomal DNA-sequencing for microbiome analyses reveals high inter-center variability', *International Journal of Medical Microbiology* **306**(5), 334–342.

## LIST OF REFERENCES

---

- Hocquet, D., Vogne, C., Garch, F. E., Vejux, A., Gotoh, N., Lee, A., Lomovskaya, O. and Plésiat, P. (2003), 'MexXY-OprM Efflux Pump Is Necessary for Adaptive Resistance of *Pseudomonas aeruginosa* to Aminoglycosides', *Antimicrobial Agents and Chemotherapy* **47**(4), 1371–1375.
- Hoeiby, N., Ciofu, O. and Bjarnsholt, T. (2010), '*Pseudomonas aeruginosa* biofilms in cystic fibrosis', *Future Microbiology* **5**(11), 1663–1674.
- Hogardt, M. and Heesemann, J. (2010), 'Adaptation of *Pseudomonas aeruginosa* during persistence in the cystic fibrosis lung', *International Journal of Medical Microbiology* **300**(8), 557–562.
- Hoiby, N., Bjarnsholt, T., Givskov, M., Molin, S. and Ciofu, O. (2010), 'Antibiotic resistance of bacterial biofilms', *International Journal of Antimicrobial Agents* **35**(4), 322–332.
- Holt, K. B. and Bard, A. J. (2005), 'Interaction of silver(I) ions with the respiratory chain of *Escherichia coli*: an electrochemical and scanning electrochemical microscopy study of the antimicrobial mechanism of micromolar Ag<sup>+</sup>', *Biochemistry* **44**(39), 13214–13223.
- Hong, K. B., Oh, H. S., Song, J. S., Lim, J.-h., Kang, D. K., Son, I. S., Park, J. D., Kim, E. C., Lee, H. J. and Choi, E. H. (2012), 'Investigation and control of an outbreak of imipenem-resistant *Acinetobacter baumannii* Infection in a Pediatric Intensive Care Unit.', *The Pediatric Infectious Disease Journal* **31**, 685–690.
- Hongoh, Y., Ohkuma, M. and Kudo, T. (2003), 'Molecular analysis of bacterial microbiota in the gut of the termite *Reticulitermes speratus* (Isoptera; Rhinotermitidae)', *FEMS Microbiology Ecology* **44**(2), 231–242.

## LIST OF REFERENCES

---

- Hopman, J., Tostmann, A., Wertheim, H., Bos, M., Kolwijck, E., Akkermans, R., Sturm, P., Voss, A., Pickkers, P. and Vd Hoeven, H. (2017), 'Reduced rate of intensive care unit acquired Gram-negative bacilli after removal of sinks and introduction of 'water-free' patient care', *Antimicrobial Resistance & Infection Control* **6**, 59.
- Horner, C., Mushtaq, S., Allen, M., Hope, R., Gerver, S., Longshaw, C., Reynolds, R., Woodford, N. and Livermore, D. M. (2021), 'Replacement of *Enterococcus faecalis* by *Enterococcus faecium* as the predominant enterococcus in UK bacteraemias', *JAC-Antimicrobial Resistance* **3**(4).
- Hota, S., Hirji, Z., Stockton, K., Lemieux, C., Dedier, H., Wolfaardt, G. and Gardam, M. A. (2009), 'Outbreak of Multidrug-Resistant *Pseudomonas aeruginosa* Colonization and Infection Secondary to Imperfect Intensive Care Unit Room Design', *Infection Control and Hospital Epidemiology* **30**(1), 25–33.
- Howard, A., O'Donoghue, M., Feeney, A. and Sleator, R. D. (2012), 'Acinetobacter baumannii: an emerging opportunistic pathogen', *Virulence* **3**(3), 243–250.
- Howell, D. and Behrends, B. (2006), 'A review of surface roughness in antifouling coatings illustrating the importance of cutoff length', *Biofouling* **22**(6), 401–410.
- URL:** <https://doi.org/10.1080/08927010601035738>
- Hu, S., Ye, X., Cai, Q., Xi, W., Shen, J., Lan, Y., Ye, Z., Ye, C., Zhang, Y., Xu, Z. and Cheng, C. (2021), 'Study on Inactivation Effects and Regeneration Inhibition Mechanism of Atmospheric-Pressure Helium Plasma Jet on *Acinetobacter Baumannii* Biofilm', *IEEE Transactions on Plasma Science* **49**(1), 307–316.

## LIST OF REFERENCES

---

- Huang, N., Mao, J., Hu, M., Wang, X. and Huo, M. (2019), 'Responses to copper stress in the metal-resistant bacterium *Cupriavidus gilardii* CR3: a whole-transcriptome analysis', *Journal of Basic Microbiology* **59**(5), 446–457.
- Huang, S., Datta, R. and Platt, R. (2006), 'Risk of Acquiring Antibiotic-Resistant Bacteria From Prior Room Occupants', *Archives of Internal Medicine* **166**(18), 1945–1951.
- Huda, S. A., Yadava, S., Kahlow, S., Jilani, M. H. and Sharma, B. (2020), 'A Rare Case of Ventilator-Associated Pneumonia Caused by *Cupriavidus Pauculus*', *Cureus* **12**(6), 8573.
- Hugerth Luisa, W., Pereira, M., Zha, Y., Seifert, M., Kaldhusdal, V., Boulund, F., Krog Maria, C., Bashir, Z., Hamsten, M., Fransson, E., Nielsen Henriette, S., Schuppe-Koistinen, I., Engstrand, L. and Zhu, L. (2020), 'Assessment of *In Vitro* and *In Silico* Protocols for Sequence-Based Characterization of the Human Vaginal Microbiome', *mSphere* **5**(6), 420–448.
- Hung, H. C., Chan, D. W., Law, L. K., Chan, E. H. and Wong, E. S. (2006), 'Industrial experience and research into the causes of SARS virus transmission in a high-rise residential housing estate in Hong Kong', *Building Services Engineering Research and Technology* **27**(2), 91–102.
- Hussein, N. H., Al-Kadmy, I. M. S., Taha, B. M. and Hussein, J. D. (2021), 'Mobilized colistin resistance (*mcr*) genes from 1 to 10: a comprehensive review.', *Molecular Biology Reports* **48**, 2897–2907.
- Ichioka, Y., Derks, J., Dahlén, G., Berglundh, T. and Larsson, L. (2021), 'In vitro evaluation of chemical decontamination of titanium discs', *Scientific Reports* **11**(1).

## LIST OF REFERENCES

---

- Inkster, T., Peters, C., Wafer, T., Holloway, D. and Makin, T. (2021), 'Investigation and control of an outbreak due to a contaminated hospital water system, identified following a rare case of *Cupriavidus pauculus* bacteraemia', *Journal of Hospital Infection* **111**, 53–64.
- Jang, A., Szabo, J., Hosni, A. A., Coughlin, M. and Bishop, P. L. (2006), 'Measurement of chlorine dioxide penetration in dairy process pipe biofilms during disinfection', *Applied Microbiology and Biotechnology* **72**(2), 368–376.
- Jarrell, K. F. and Kropinski, A. M. (1982), 'The virulence of protease and cell surface mutants of *Pseudomonas aeruginosa* for the larvae of *Galleria mellonella*', *Journal of Invertebrate Pathology* **39**(3), 395–400.
- Jayakumar, R., Prabakaran, M., Nair, S. V. and Tamura, H. (2010), 'Novel chitin and chitosan nanofibers in biomedical applications', *Biotechnology Advances* **28**(1), 142–150.
- Jia, H., Fang, R., Lin, J., Tian, X., Zhao, Y., Chen, L., Cao, J. and Zhou, T. (2020), 'Evaluation of resazurin-based assay for rapid detection of polymyxin-resistant Gram-negative bacteria', *BMC Microbiology* **20**(1), 7.
- Johnson, C. M. and Grossman, A. D. (2015), 'Integrative and Conjugative Elements (ICEs): What They Do and How They Work', *Annual Review of Genetics* **49**(1), 577–601.
- Jones, B. A., Grace, D., Kock, R., Alonso, S., Rushton, J., Said, M. Y., McKeever, D., Mutua, F., Young, J., McDermott, J. and Pfeiffer, D. U. (2013), 'Zoonosis emergence linked to agricultural intensification and environmental change', *PNAS* **110**, 8399–8404.

## LIST OF REFERENCES

---

- Jones, K. E., Patel, N. G., Levy, M. A., Storeygard, A., Balk, D., Gittleman, J. L. and Daszak, P. (2008), 'Global trends in emerging infectious diseases', *Nature* **451**, 990–993.
- Joshi, L. T., Welsch, A., Hawkins, J. and Baillie, L. (2017), 'The effect of hospital biocide sodium dichloroisocyanurate on the viability and properties of *Clostridium difficile* spores', *Letters in Applied Microbiology* **65**(3), 199–205.
- Joshi, N., Jain, N., Pathak, A., Singh, J., Prasad, R. and Upadhyaya, C. (2018), 'Biosynthesis of silver nanoparticles using *Carissa carandas* berries and its potential antibacterial activities', *Journal of Sol-Gel Science and Technology* **86**.
- Kalka-Moll, W. M., LiPuma, J. J., Accurso, F. J., Plum, G., van Koningsbruggen, S. and Vandamme, P. (2009), 'Airway Infection with a Novel *Cupriavidus* Species in Persons with Cystic Fibrosis', *Journal of Clinical Microbiology* **47**(9), 3026–3028.
- Kaplan, J. B. (2010), 'Biofilm dispersal: mechanisms, clinical implications, and potential therapeutic uses.', *Journal of Dental Research* **89**, 205–218.
- Karbysheva, S., Di Luca, M., Butini, M. E., Winkler, T., Schütz, M. and Trampuz, A. (2020), 'Comparison of sonication with chemical biofilm dislodgement methods using chelating and reducing agents: Implications for the microbiological diagnosis of implant associated infection', *PLOS ONE* **15**(4), 1–15.
- Karesh, W. B., Dobson, A., Lloyd-Smith, J. O., Lubroth, J., Dixon, M. A., Bennett, M., Aldrich, S., Harrington, T., Formenty, P., Loh, E. H., Machalaba, C. C., Thomas, M. J. and Heymann, D. L. (2012), 'Ecology of zoonoses: natural and unnatural histories', *Lancet* **380**, 1936–1945.

## LIST OF REFERENCES

---

- Kennedy, K., Hall, M. W., Lynch, M. D. J., Moreno-Hagelsieb, G. and Neufeld, J. D. (2014), 'Evaluating bias of illumina-based bacterial 16S rRNA gene profiles', *Applied and Environmental Microbiology* **80**, 5717–5722.
- Keren, I., Kaldalu, N., Spoering, A., Wang, Y. and Lewis, K. (2004), 'Persister cells and tolerance to antimicrobials', *FEMS Microbiology Letters* **230**(1), 13–18.
- Kihlken, M. A., Singleton, C. and Le Brun, N. E. (2008), 'Distinct characteristics of Ag<sup>+</sup> and Cd<sup>2+</sup> binding to CopZ from *Bacillus subtilis*', *Journal of Biological Inorganic Chemistry* **13**(6).
- Kim, L. (2001), 'Riddle of biofilm resistance', *Antimicrobial Agents and Chemotherapy* **45**(4), 999–1007.
- Klasen, H. J. (2000), 'Historical review of the use of silver in the treatment of burns', *Burns* **26**, 117–130.
- Klevens, R. M., Edwards, J. R., Richards, Chesley L., J., Horan, T. C., Gaynes, R. P., Pollock, D. A. and Cardo, D. M. (2007), 'Estimating health care-associated infections and deaths in U.S. hospitals, 2002', *Public Health Reports* **122**(2), 160–166.
- Klindworth, A., Pruesse, E., Schweer, T., Peplies, J., Quast, C., Horn, M. and Glöckner, F. O. (2012), 'Evaluation of general 16S ribosomal RNA gene PCR primers for classical and next-generation sequencing-based diversity studies', *Nucleic Acids Research* **41**(1).
- Klockgether, J., Cramer, N., Wiehlmann, L., Davenport, C. and Tümmler, B. (2011), '*Pseudomonas aeruginosa* Genomic Structure and Diversity', *Frontiers in Microbiology* **2**.

## LIST OF REFERENCES

---

- Klockgether, J., Munder, A., Neugebauer, J., Davenport, C. F., Stanke, F., Larbig, K. D., Heeb, S., Schöck, U., Pohl, T. M., Wiehlmann, L. and Tümmler, B. (2010), 'Genome Diversity of *Pseudomonas aeruginosa* PAO1 Laboratory Strains', *Journal of Bacteriology* **192**(4), 1113–1121.
- Klonowska, A., Moulin, L., Ardley, J. K., Braun, F., Gollagher, M. M., Zandberg, J. D., Marinova, D. V., Huntemann, M., Reddy, T. B. K., Varghese, N. J., Woyke, T., Ivanova, N., Seshadri, R., Kyrpides, N. and Reeve, W. G. (2020), 'Novel heavy metal resistance gene clusters are present in the genome of *Cupriavidus neocaledonicus* STM 6070, a new species of *Mimosa pudica* microsymbiont isolated from heavy-metal-rich mining site soil', *BMC Genomics* **21**(1), 214.
- Klueh, U., Wagner, V., Kelly, S., Johnson, A. and Bryers, J. D. (2000), 'Efficacy of silver-coated fabric to prevent bacterial colonization and subsequent device-based biofilm formation', *Journal of Biomedical Materials Research* **53**(6), 621–631.
- Knoester, M., de Boer, M. G. J., Maarleveld, J. J., Claas, E. C. J., Bernards, A. T., de Jonge, E., van Dissel, J. T. and Veldkamp, K. E. (2014), 'An integrated approach to control a prolonged outbreak of multidrug-resistant *Pseudomonas aeruginosa* in an intensive care unit.', *Clinical Microbiology and Infection* **20**, 207–215.
- Koch, M. J., Hesketh-Best, P. J., Smerdon, G., Warburton, P. J., Howell, K. and Upton, M. (2021), 'Impact of growth media and pressure on the diversity and antimicrobial activity of isolates from two species of hexactinellid sponge', *Microbiology* **167**(12).
- Kora, A. J. and Jayaraman, A. (2012), 'Green Fabrication of Silver Nanoparti-



## LIST OF REFERENCES

---

- cles by Gum Tragacanth (*Astragalus gummifer*): A Dual Functional Reductant and Stabilizer', *Journal of Nanomaterials* .
- Kotay, S., Chai, W., Guilford, W., Barry, K. and Mathers, A. J. (2017), 'Spread from the Sink to the Patient: *In Situ* Study Using Green Fluorescent Protein (GFP)-Expressing *Escherichia coli* To Model Bacterial Dispersion from Hand-Washing Sink-Trap Reservoirs', *Applied and Environmental Microbiology* **83**(8).
- Kotay, S., Donlan, R. M., Ganim, C., Barry, K., Christensen, B. E. and Mathers, A. J. (2018), 'Droplet rather than aerosol mediated dispersion is the primary mechanism of bacterial transmission from contaminated hand washing sink traps', *Applied and Environmental Microbiology* **85**(2).
- Kotay, S. M., Parikh, H. I., Barry, K., Gweon, H. S., Guilford, W., Carroll, J. and Mathers, A. J. (2020), 'Nutrients influence the dynamics of *Klebsiella pneumoniae* carbapenemase producing enterobacterales in transplanted hospital sinks', *Water Research* **176**.
- Kotsanas, D., Wijesooriya, W. R. P. L. I., Korman, T. M., Gillespie, E. E., Wright, L., Snook, K., Williams, N., Bell, J. M., Li, H. Y. and Stuart, R. L. (2013), "'Down the drain": carbapenem-resistant bacteria in intensive care unit patients and handwashing sinks.', *The Medical Journal of Australia* **198**, 267–269.
- Kramer, A., Schwebke, I. and Kampf, G. (2006), 'How long do nosocomial pathogens persist on inanimate surfaces? A systematic review', *BMC infectious diseases* **6**, 130–130.
- La Forgia, C., Franke, J., Hacek, D. M., Thomson, R. B. J., Robicsek, A. and Peterson, L. R. (2010), 'Management of a multidrug-resistant *Acinetobacter*

## LIST OF REFERENCES

---

- baumannii* outbreak in an intensive care unit using novel environmental disinfection: a 38-month report', *American Journal of Infection Control* **38**, 259–263.
- Labadie, M., Randrianjatovo-Gbalou, I., Zaidi-Ait-Salem, M., Dossat-Létisse, V., Fontagné-Faucher, C. and Marcato-Romain, C.-E. (2021), 'A dynamic re-sazurin microassay allowing accurate quantification of cells and suitable for acid-forming bacteria', *Journal of Microbiological Methods* **183**.
- Lambiase, A., Raia, V., Pezzo, M. D., Sepe, A., Carnovale, V. and Rossano, F. (2006), 'Microbiology of airway disease in a cohort of patients with Cystic Fibrosis', *BMC Infectious Diseases* **6**(1), 4.
- Langevin, S., Vincelette, J., Bekal, S. and Gaudreau, C. (2011), 'First Case of Invasive Human Infection Caused by *Cupriavidus metallidurans*', *Journal of Clinical Microbiology* **49**(2), 744.
- Langford, B. J., So, M., Raybardhan, S., Leung, V., Westwood, D., MacFadden, D. R., Soucy, J.-P. R. and Daneman, N. (2020), 'Bacterial co-infection and secondary infection in patients with COVID-19: a living rapid review and meta-analysis', *Clinical Microbiology and Infection* **26**(12), 1622–1629.
- Larsen, J., Raisen, C. L., Ba, X., Sadgrove, N. J., Padilla-González, G. F., Simmonds, M. S. J., Loncaric, I., Kerschner, H., Apfalter, P., Hartl, R., Deplano, A., Vandendriessche, S., Černá Bolfíková, B., Hulva, P., Arendrup, M. C., Hare, R. K., Barnadas, C., Stegger, M., Sieber, R. N., Skov, R. L., Petersen, A., Angen, O., Rasmussen, S. L., Espinosa-Gongora, C., Aarestrup, F. M., Lindholm, L. J., Nykäsenoja, S. M., Laurent, F., Becker, K., Walther, B., Kehrenberg, C., Cuny, C., Layer, F., Werner, G., Witte, W., Stamm, I., Moroni, P., Jørgensen, H. J., de Lencastre, H., Cercenado, E., García-Garrote, F.,

## LIST OF REFERENCES

---

- Börjesson, S., Hæggman, S., Perreten, V., Teale, C. J., Waller, A. S., Pichon, B., Curran, M. D., Ellington, M. J., Welch, J. J., Peacock, S. J., Seilly, D. J., Morgan, F. J. E., Parkhill, J., Hadjirin, N. F., Lindsay, J. A., Holden, M. T. G., Edwards, G. F., Foster, G., Paterson, G. K., Didelot, X., Holmes, M. A., Harrison, E. M. and Larsen, A. R. (2022), 'Emergence of methicillin resistance predates the clinical use of antibiotics', *Nature* .
- Latorre, M. C., Pérez-Granda, M. J., Savage, P. B., Alonso, B., Martín-Rabadán, P., Samaniego, R., Bouza, E., Muñoz, P. and Guembe, M. (2021), 'Endotracheal tubes coated with a broad-spectrum antibacterial ceragenin reduce bacterial biofilm in an *in vitro* bench top model', *Journal of Antimicrobial Chemotherapy* **76**(5), 1168–1173.
- Laurent, P., Aurélie, J. and Patrice, N. (2017), 'Polymyxins: Antibacterial activity, susceptibility testing, and resistance mechanisms encoded by plasmids or chromosomes', *Clinical Microbiology Reviews* **30**(2), 557–596.
- Laventie, B.-J., Sangermani, M., Estermann, F., Manfredi, P., Planes, R., Hug, I., Jaeger, T., Meunier, E., Broz, P. and Jenal, U. (2019), 'A Surface-Induced Asymmetric Program Promotes Tissue Colonization by *Pseudomonas aeruginosa*', *Cell Host & Microbe* **25**(1), 140–152.
- Layton, B., Walters, S., Lam, L. and Boehm, A. (2010), '*Enterococcus* species distribution among human and animal hosts using multiplex PCR', *Journal of Applied Microbiology* **109**(2), 539–547.
- Lead, J. R., Batley, G. E., Alvarez, P. J. J., Croteau, M. N., Handy, R. D., McLaughlin, M. J., Judy, J. D. and Schirmer, K. (2018), 'Nanomaterials in the environment: Behavior, fate, bioavailability, and effects-An updated review', *Environmental Toxicology and Chemistry* **37**(8), 2029–2063.

## LIST OF REFERENCES

---

- Ledwoch, K., Robertson, A., Lauran, J., Norville, P. and Maillard, J. Y. (2020), 'It's a trap! The development of a versatile drain biofilm model and its susceptibility to disinfection', *Journal of Hospital Infection* **106**(4), 757–764.
- Lee, C.-R., Lee, J. H., Park, M., Park, K. S., Bae, I. K., Kim, Y. B., Cha, C.-J., Jeong, B. C. and Lee, S. H. (2017), 'Biology of *Acinetobacter baumannii*: Pathogenesis, Antibiotic Resistance Mechanisms, and Prospective Treatment Options', *Frontiers in Cellular and Infection Microbiology* **7**, 55.
- Leitner, E., Zarfel, G., Luxner, J., Herzog, K., Pekard-Amenitsch, S., Hoenigl, M., Valentin, T., Feierl, G., Grisold, A. J., Hogenauer, C., Sill, H., Krause, R. and Zollner-Schwetz, I. (2015), 'Contaminated handwashing sinks as the source of a clonal outbreak of KPC-2-producing *Klebsiella oxytoca* on a hematology ward', *Antimicrobial Agents and Chemotherapy* **59**(1), 714–716.
- Lejeune, P. (2003), 'Contamination of abiotic surfaces: what a colonizing bacterium sees and how to blur it', *Trends in Microbiology* **11**(4), 179–184.
- Lemire, J. A., Harrison, J. J. and Turner, R. J. (2013), 'Antimicrobial activity of metals: mechanisms, molecular targets and applications', *Nature Reviews Microbiology* **11**, 371.
- Lemmen, S., Hafner, H., Zolldann, D., Stanzel, S. and Lutticken, R. (2004), 'Distribution of multi-resistant Gram-negative versus Gram-positive bacteria in the hospital inanimate environment', *Journal of Hospital Infection* **56**(3), 191–197.
- Lerminiaux, N. A. and Cameron, A. D. S. (2019), 'Horizontal transfer of antibiotic resistance genes in clinical environments', *Canadian Journal of Microbiology* **65**(1), 34–44.

## LIST OF REFERENCES

---

- Lescat, Mathilde and Poirel, L., Tinguely, C. and Nordmann, P. (2022), 'A Resazurin Reduction-Based Assay for Rapid Detection of Polymyxin Resistance in *Acinetobacter baumannii* and *Pseudomonas aeruginosa*', *Journal of Clinical Microbiology* **57**(3).
- Levy, S. (2002), 'Active efflux, a common mechanism for biocide and antibiotic resistance', *Journal of Applied Microbiology* **92**, 65—71.
- Lewis, J. A. (1998), 'Marine biofouling and its prevention on underwater surfaces', *Materials Forum* **22**, 41–61.
- Li, J., Liu, L., Yang, D., Liu, W.-l., Shen, Z.-Q., Qu, H.-m., Qiu, Z.-G., Hou, A.-m., Wang, D.-N., Ding, C.-s., Li, J.-W., Guo, J.-h. and Jin, M. (2017), 'Culture-dependent enumeration methods failed to simultaneously detect disinfectant-injured and genetically modified *Escherichia coli* in drinking water', *Environmental Science: Processes & Impacts* **19**, 720–726.
- Li, L., Mendis, N., Trigui, H., Oliver, J. D. and Faucher, S. P. (2014), 'The importance of the viable but non-culturable state in human bacterial pathogens', *Frontiers in Microbiology* **5**(258).
- Li, X.-Z. and Nikaido, H. (2009), 'Efflux-Mediated Drug Resistance in Bacteria', *Drugs* **69**(12), 1555–1623.
- Liao, H., Jiang, L. and Zhang, R. (2018), 'Induction of a viable but non-culturable state in *Salmonella typhimurium* by thermosonication and factors affecting resuscitation', *FEMS Microbiology Letters* **365**.
- Liao, X., Yang, F., Li, H., So, P.-K., Yao, Z., Xia, W. and Sun, H. (2017), 'Targeting the Thioredoxin Reductase-Thioredoxin System from *Staphylococcus aureus* by Silver Ions', *Inorganic Chemistry* **56**(24), 14823–14830.

## LIST OF REFERENCES

---

- Lin, Q. Y., Tsai, Y.-L., Liu, M.-C., Lin, W.-C., Hsueh, P.-R. and Liaw, S.-J. (2014), 'Serratia marcescens arn, a PhoP-regulated locus necessary for polymyxin B resistance.', *Antimicrobial Agents and Chemotherapy* **58**, 5181–5190.
- Ling, Z., Yin, W., Shen, Z., Wang, Y., Shen, J. and Walsh, T. R. (2020), 'Epidemiology of mobile colistin resistance genes mcr-1 to mcr-9', *Journal of Antimicrobial Chemotherapy* **75**(11), 3087–3095.
- LiPuma, J. J. (2010), 'The Changing Microbial Epidemiology in Cystic Fibrosis', *Clinical Microbiology Reviews* **23**(2), 299–323.
- Liu, W., Røder, H. L., Madsen, J. S., Bjarnsholt, T., Sørensen, S. J. and Burmølle, M. (2016), 'Interspecific bacterial interactions are reflected in multi-species biofilm spatial organization', *Frontiers in Microbiology* **7**.
- Llanes, C., Köhler, T., Patry, I., Dehecq, B., Delden, C. v. and Plésiat, P. (2011), 'Role of the MexEF-OprN Efflux System in Low-Level Resistance of *Pseudomonas aeruginosa* to Ciprofloxacin', *Antimicrobial Agents and Chemotherapy* **55**(12), 5676–5684.
- Lleò, M. d. M., Pierobon, S., Tafi, M. C., Signoretto, C. and Canepari, P. (2000), 'mRNA Detection by Reverse Transcription-PCR for Monitoring Viability over Time in an *Enterococcus faecalis* Viable but Nonculturable Population Maintained in a Laboratory Microcosm', *Applied and Environmental Microbiology* **66**(10), 4564–4567.
- Lleò, M. d. M., Tafi, M. C. and Canepari, P. (1998), 'Nonculturable *Enterococcus faecalis* Cells Are Metabolically Active and Capable of Resuming Active Growth', *Systematic and Applied Microbiology* **21**(3), 333–339.

## LIST OF REFERENCES

---

- Long, Y. M., Hu, L. G., Yan, X. T., Zhao, X. C., Zhou, Q. F., Cai, Y. and Jiang, G. B. (2017), 'Surface ligand controls silver ion release of nanosilver and its antibacterial activity against *Escherichia coli*', *International Journal of Nanomedicine* **12**, 3193–3206.
- Loo, Y. Y., Rukayadi, Y., Nor-Khaizura, M.-A.-R., Kuan, C. H., Chieng, B. W., Nishibuchi, M. and Radu, S. (2018), 'In Vitro Antimicrobial Activity of Green Synthesized Silver Nanoparticles Against Selected Gram-negative Food-borne Pathogens', *Frontiers in Microbiology* **9**.
- Loong, S. K., Khor, C. S., Jafar, F. L. and AbuBakar, S. (2016), 'Utility of 16S rDNA Sequencing for Identification of Rare Pathogenic Bacteria', *Journal of Clinical Laboratory Analysis* **30**, 1056–1060.
- Lopeman, R. C., Harrison, J., Rathbone, D. L., Desai, M., Lambert, P. A. and Cox, J. A. G. (2020), 'Effect of Amoxicillin in combination with Imipenem-Relebactam against *Mycobacterium abscessus*', *Scientific Reports* **10**(1), 928.
- Loutet, S. A. and Valvano, M. A. (2010), 'A decade of *Burkholderia cenocepacia* virulence determinant research', *Infection and Immunity* **78**(10), 4088–4100.
- Lowe, C., Willey, B., O'Shaughnessy, A., Lee, W., Lum, M., Pike, K., Larocque, C., Dedier, H., Dales, L., Moore, C. and McGeer, A. (2012), 'Outbreak of extended-spectrum beta-lactamase-producing *Klebsiella oxytoca* infections associated with contaminated handwashing sinks', *Emerging Infectious Diseases* **18**(8), 1242–1247.
- Lu, H., Giordano, F. and Ning, Z. (2016), 'Oxford Nanopore MinION Sequencing and Genome Assembly', *Genomics, Proteomics & Bioinformatics* **14**(5), 265–279.

## LIST OF REFERENCES

---

- Lu, J., Wang, Y., Jin, M., Yuan, Z., Bond, P. and Guo, J. (2020), 'Both silver ions and silver nanoparticles facilitate the horizontal transfer of plasmid-mediated antibiotic resistance genes', *Water Research* **169**.
- Lüdecke, C., Roth, M., Yu, W., Horn, U., Bossert, J. and Jandt, K. D. (2016), 'Nanorough titanium surfaces reduce adhesion of *Escherichia coli* and *Staphylococcus aureus* via nano adhesion points.', *Colloids and surfaces. B, Biointerfaces* **145**, 617–625.
- Mackay, W. G., Whitehead, S., Purdue, N., Smith, M., Redhead, N., Williams, C. and Wilson, S. (2017), 'Infection control implications of the laundering of ambulance staff uniforms and reusable mops', *Journal of Hospital Infection* **96**, 59–62.
- Mackenzie, J. S. and Jeggo, M. (2019), 'The One Health Approach - Why Is It So Important?', *Tropical Medicine and Infectious Disease* **4**, 88.
- Mackley, A., Baker, C., and Bate, A. (2018), 'Raising standards of infection prevention and control in the NHS', *House of Commons Library* **CDP-2018-0116**.
- Madigan, M. T. (2017), *Brock Biology of Microorganisms, Global Edition*, Pearson Education.
- Mahoney, A. R., Safaee, M. M., Wuest, W. M. and Furst, A. L. (2021), 'The silent pandemic: Emergent antibiotic resistances following the global response to SARS-CoV-2', *iScience* **24**(4).
- Malhotra, S., Hayes, D. J. and Wozniak, D. J. (2019), 'Cystic Fibrosis and *Pseudomonas aeruginosa*: the Host-Microbe Interface.', *Clinical Microbiology Reviews* **32**.



## LIST OF REFERENCES

---

- Mandakhalikar, K. D., Rahmat, J. N., Chiong, E., Neoh, K. G., Shen, L. and Tambyah, P. A. (2018), 'Extraction and quantification of biofilm bacteria: Method optimized for urinary catheters', *Scientific Reports* **8**(1), 8069.
- Manyi-Loh, C., Mamphweli, S., Meyer, E. and Okoh, A. (2018), 'Antibiotic Use in Agriculture and Its Consequential Resistance in Environmental Sources: Potential Public Health Implications', *Molecules* **23**(4).
- Marin, M., Leung, J., Lopez, A. S., Shepersky, L., Schmid, D. S. and Gershon, A. A. (2021), 'Communicability of varicella before rash onset: a literature review', *Epidemiology and Infection* **149**, 131.
- Marquès, C., Tasse, J., Pracros, A., Collin, V., Franceschi, C., Laurent, F., Chatellier, S. and Forestier, C. (2015), 'Effects of antibiotics on biofilm and unattached cells of a clinical *Staphylococcus aureus* isolate from bone and joint infection', *Journal of Medical Microbiology* **64**(9), 1021–1026.
- Martins, J. D. N., Freire, E. and Hemadipour, H. (2009), 'Applications and market of PVC for piping industry', *Polimeros* **19**, 58–62.
- Masciangioli, T. and Zhang, W. (2003), 'Environmental Technologies at the Nanoscale', *Environmental Science and Technology* **37**(5), 102–108.
- Massip, C., Coullaud-Gamel, M., Gaudru, C., Amoureux, L., Doleans-Jordheim, A., Hery-Arnaud, G., Marchandin, H., Oswald, E., Segonds, C. and Guet-Revillet, H. (2020), 'In vitro activity of 20 antibiotics against *Cupriavidus* clinical strains', *Journal of Antimicrobial Chemotherapy* **75**(6), 1654–1658.
- Matsuo, Y., Komiya, S., Yasumizu, Y., Yasuoka, Y., Mizushima, K., Takagi, T., Kryukov, K., Fukuda, A., Morimoto, Y., Naito, Y., Okada, H., Bono, H., Nakagawa, S. and Hirota, K. (2021), 'Full-length 16S rRNA gene amplicon anal-

## LIST OF REFERENCES

---

- ysis of human gut microbiota using MinION nanopore sequencing confers species-level resolution', *BMC Microbiology* **21**(1), 35.
- Mazhar, S. H., Herzberg, M., Ben Fekih, I., Zhang, C., Bello, S. K., Li, Y. P., Su, J., Xu, J., Feng, R., Zhou, S. and Rensing, C. (2020), 'Comparative Insights Into the Complete Genome Sequence of Highly Metal Resistant *Cupriavidus metallidurans* Strain BS1 Isolated From a Gold-Copper Mine', *Frontiers in Microbiology* **11**, 47.
- McBain, A. J., Bartolo, R. G., Catrenich, C. E., Charbonneau, D., Ledder, R. G., Rickard, A. H., Symmons, S. A. and Gilbert, P. (2003), 'Microbial characterization of biofilms in domestic drains and the establishment of stable biofilm microcosms', *Applied and Environmental Microbiology* **69**, 177–185.
- McBride, S. M., Fischetti, V. A., LeBlanc, D. J., Moellering, Jr., R. C. and Gilmore, M. S. (2007), 'Genetic Diversity among *Enterococcus faecalis*', *PLOS ONE* **2**(7), 1–22.
- McConnell, M. J., Actis, L. and Pachón, J. (2013), '*Acinetobacter baumannii*: human infections, factors contributing to pathogenesis and animal models', *FEMS Microbiology Reviews* **37**(2), 130–155.
- McKenzie, D. A. (1962), 'Milk Testing - A Forward Look', *International Journal of Dairy Technology* **15**(4), 207–212.
- Menezes, R. d. P., Marques, L. d. A., Silva, F. F., Silva, N. B. S., Alves, P. G. V., Bessa, M. A. d. S., Araújo, L. B. d., Penatti, M. P. A., Pedroso, R. D. S. and Brito Röder, D. V. D. d. (2022), 'Inanimate Surfaces and Air Contamination with Multidrug Resistant Species of *Staphylococcus* in the Neonatal Intensive Care Unit Environment', *Microorganisms* **10**.

## LIST OF REFERENCES

---

- Meran, Z., Besinis, A., De Peralta, T. and Handy, R. D. (2018), 'Antifungal properties and biocompatibility of silver nanoparticle coatings on silicone maxillo-facial prostheses *in vitro*', *Journal of Biomedical Materials Research Part B: Applied Biomaterials* **106**(3), 1038–1051.
- Merritt, J. H., Kadouri, D. E. and O'Toole, G. A. (2005), 'Growing and analyzing static biofilms', *Current Protocols in Microbiology* **1**.
- Mi, G., Shi, D., Wang, M. and Webster, T. J. (2018), 'Reducing Bacterial Infections and Biofilm Formation Using Nanoparticles and Nanostructured Antibacterial Surfaces', *Advanced Healthcare Materials* **7**(13).
- Migliara, G., Di Paolo, C., Barbato, D., Baccolini, V., Salerno, C., Nardi, A., Alessandri, F., Giordano, A., Tufi, D., Marinelli, L., Cottarelli, A., De Giusti, M., Marzuillo, C., De Vito, C., Antonelli, G., Venditti, M., Tellan, G., Ranieri, M. V. and Villari, P. (2019), 'Multimodal surveillance of healthcare associated infections in an intensive care unit of a large teaching hospital.', *Annali di igiene : medicina preventiva e di comunita* **31**, 399–413.
- Miles, A. A., Misra, S. S. and Irwin, J. O. (1938), 'The estimation of the bactericidal power of the blood', *The Journal of Hygiene* **38**(6), 732–749.
- Miller, W. R., Murray, B. E., Rice, L. B. and Arias, C. A. (2016), 'Vancomycin-Resistant Enterococci: Therapeutic Challenges in the 21st Century', *Infectious Disease Clinics of North America* **30**(2), 415–439.
- Mitchell, B., Dancer, S., Anderson, M. and Dehn, E. (2015), 'Risk of organism acquisition from prior room occupants: a systematic review and meta-analysis', *Journal of Hospital Infection* **91**(3), 211–217.

## LIST OF REFERENCES

---

- Mitik-Dineva, N., Wang, J., Mocanasu, R. C., Stoddart, P. R., Crawford, R. J. and Ivanova, E. P. (2008), 'Impact of nano-topography on bacterial attachment.', *Biotechnology Journal* **3**, 536–544.
- Moat, J., Rizoulis, A., Fox, G. and Upton, M. (2016), 'Domestic shower hose biofilms contain fungal species capable of causing opportunistic infection.', *Journal of Water and Health* **14**, 727–737.
- Moissenet, D., Goujon, C. P., Garbarg-Chenon, A. and Vu-Thien, H. (1999), 'CDC group IV c-2: a new *Ralstonia* species close to *Ralstonia eutropha*', *Journal of Clinical Microbiology* **37**(6), 1777–1781.
- Monopoli, M. P., Åberg, C., Salvati, A. and Dawson, K. A. (2012), 'Biomolecular coronas provide the biological identity of nanosized materials', *Nature Nanotechnology* **7**(12), 779–786.
- Moore, M. P., Lamont, I. L., Williams, D., Paterson, S., Kukavica-Ibrulj, I., Tucker, N. P., Kenna, D. T. D., Turton, J. F., Jeukens, J., Freschi, L., Wee, B. A., Loman, N. J., Holden, S., Manzoor, S., Hawkey, P., Southern, K. W., Walshaw, M. J., Levesque, R. C., Fothergill, J. L. and Winstanley, C. (2021), 'Transmission, adaptation and geographical spread of the *Pseudomonas aeruginosa* Liverpool epidemic strain', *Microbial Genomics* **7**(3).
- Moradali, M. F., Ghods, S. and Rehm, B. H. A. (2017), '*Pseudomonas aeruginosa* Lifestyle: A Paradigm for Adaptation, Survival, and Persistence', *Frontiers in Cellular and Infection Microbiology* **7**, 39–39.
- Moradigaravand, D., Gouliouris, T., Ludden, C., Reuter, S., Jamrozy, D., Blane, B., Naydenova, P., Judge, K., H Aliyu, S., F Hadjirin, N., A Holmes, M., Török, E., M Brown, N., Parkhill, J. and Peacock, S. (2018), 'Genomic survey of

## LIST OF REFERENCES

---

- Clostridium difficile* reservoirs in the East of England implicates environmental contamination of wastewater treatment plants by clinical lineages.’, *Microbial Genomics* **4**.
- Mordue, J., O’Boyle, N., Gadegaard, N. and Roe, A. J. (2021), ‘The force awakens: The dark side of mechanosensing in bacterial pathogens’, *Cellular Signalling* **78**.
- Mueller, N. C. and Nowack, B. (2008), ‘Exposure Modeling of Engineered Nanoparticles in the Environment’, *Environmental Science & Technology* **42**(12), 4447–4453.
- Muller, M. (2018), ‘Bacterial silver resistance gained by cooperative interspecies redox behavior’, *Antimicrobial Agents and Chemotherapy* **62**(8).
- Murray, C. J. L., Ikuta, K. S., Sharara, F., Swetschinski, L., Robles Aguilar, G., Gray, A., Han, C., Bisignano, C., Rao, P., Wool, E., Johnson, S. C., Browne, A. J., Chipeta, M. G., Fell, F., Hackett, S., Haines-Woodhouse, G., Kashef Hamadani, B. H., Kumaran, E. A. P., McManigal, B., Agarwal, R., Akech, S., Albertson, S., Amuasi, J., Andrews, J., Aravkin, A., Ashley, E., Bailey, F., Baker, S., Basnyat, B., Bekker, A., Bender, R., Bethou, A., Bielicki, J., Boonkasidecha, S., Bukosia, J., Carvalheiro, C., Castañeda-Orjuela, C., Chansamouth, V., Chaurasia, S., Chiurchiù, S., Chowdhury, F., Cook, A. J., Cooper, B., Cressey, T. R., Criollo-Mora, E., Cunningham, M., Darboe, S., Day, N. P. J., De Luca, M., Dokova, K., Dramowski, A., Dunachie, S. J., Eckmanns, T., Eibach, D., Emami, A., Feasey, N., Fisher-Pearson, N., Forrest, K., Garrett, D., Gastmeier, P., Giref, A. Z., Greer, R. C., Gupta, V., Haller, S., Haselbeck, A., Hay, S. I., Holm, M., Hopkins, S., Iregbu, K. C., Jacobs, J., Jarovsky, D., Javanmardi, F., Khorana, M., Kisson, N., Kobeissi,

## LIST OF REFERENCES

---

- E., Kostyanev, T., Krapp, F., Krumkamp, R., Kumar, A., Kyu, H. H., Lim, C., Limmathurotsakul, D., Loftus, M. J., Lunn, M., Ma, J., Mturi, N., Munera-Huertas, T., Musicha, P., Mussi-Pinhata, M. M., Nakamura, T., Nanavati, R., Nangia, S., Newton, P., Ngoun, C., Novotney, A., Nwakanma, D., Obiero, C. W., Olivas-Martinez, A., Olliaro, P., Ooko, E., Ortiz-Brizuela, E., Peleg, A. Y., Perrone, C., Plakkal, N., Ponce-de Leon, A., Raad, M., Ramdin, T., Riddell, A., Roberts, T., Robotham, J. V., Roca, A., Rudd, K. E., Russell, N., Schnall, J., Scott, J. A. G., Shivamallappa, M., Sifuentes-Osornio, J., Steenkeste, N., Stewardson, A. J., Stoeva, T., Tasak, N., Thaiprakong, A., Thwaites, G., Turner, C., Turner, P., van Doorn, H. R., Velaphi, S., Vongpradith, A., Vu, H., Walsh, T., Waner, S., Wangrangsimakul, T., Wozniak, T., Zheng, P., Sartorius, B., Lopez, A. D., Stergachis, A., Moore, C., Dolecek, C. and Naghavi, M. (2022), 'Global burden of bacterial antimicrobial resistance in 2019: a systematic analysis', *The Lancet* **399**, 629–655.
- Muyzer, G., de Waal, E. C. and Uitterlinden, A. G. (1993), 'Profiling of complex microbial populations by denaturing gradient gel electrophoresis analysis of polymerase chain reaction-amplified genes coding for 16S rRNA', *Applied and Environmental Microbiology* **59**(3), 695–700.
- Nakamura, I., Yamaguchi, T., Miura, Y. and Watanabe, H. (2021), 'Transmission of extended-spectrum beta-lactamase-producing *Klebsiella pneumoniae* associated with sinks in a surgical hospital ward, confirmed by single-nucleotide polymorphism analysis', *Journal of Hospital Infection* **118**, 1–6.
- National Institute for Health and Care Excellence (2014), 'Infection prevention and control; quality standard 61'.

## LIST OF REFERENCES

---

- National Institute for Health and Care Excellence (2016), 'Healthcare-associated infections: Quality standard 113'.
- Navya, P. N. and Daima, H. K. (2016), 'Rational engineering of physicochemical properties of nanomaterials for biomedical applications with nanotoxicological perspectives.', *Nano Convergence* **3**, 1.
- Ngoi, S. T., Chong, C. W., Ponnampalavanar, S. S. L. S., Tang, S. N., Idris, N., Abdul Jabar, K., Gregory, M. J., Husain, T. and Teh, C. S. J. (2021), 'Genetic mechanisms and correlated risk factors of antimicrobial-resistant ESKAPEE pathogens isolated in a tertiary hospital in Malaysia', *Antimicrobial Resistance & Infection Control* **10**(1), 70.
- Nikaido, H., Nikaido, K. and Harayama, S. (1991), 'Identification and characterization of porins in *Pseudomonas aeruginosa*', *Journal of Biological Chemistry* **266**(2), 770–779.
- Noble, M. A., Isaac-Renton, J. L., Bryce, E. A., Roscoe, D. L., Roberts, F. J., Walker, M., Scharf, S., Walsh, A., Altamirano-Dimas, M. and Gribble, M. (1998), 'The toilet as a transmission vector of vancomycin-resistant enterococci', *Journal of Hospital Infection* **40**, 237–241.
- Nurjadi, D., Scherrer, M., Frank, U., Mutters, N. T., Heining, A., Späth, I., Eichel, V. M., Jabs, J., Probst, K., Müller-Tidow, C., Brandt, J., Heeg, K. and Boutin, S. (2021), 'Genomic Investigation and Successful Containment of an Intermittent Common Source Outbreak of OXA-48-Producing *Enterobacter cloacae* Related to Hospital Shower Drains', *Microbiology Spectrum* **9**.
- Nweze, E. I., Ghannoum, A., Chandra, J., Ghannoum, M. A. and Mukherjee, P. K. (2012), 'Development of a 96-well catheter-based microdilution method

## LIST OF REFERENCES

---

- to test antifungal susceptibility of *Candida* biofilms', *Journal of Antimicrobial Chemotherapy* **67**, 149–153.
- Oberdörster, G., Finkelstein, J. N., Johnston, C., Gelein, R., Cox, C., Baggs, R. and Elder, A. C. (2000), 'Acute pulmonary effects of ultrafine particles in rats and mice.', *Research Reports of the Health Effects Institute* pp. 5–74.
- O'Brien, J., Wilson, I., Orton, T. and Pognan, F. (2000), 'Investigation of the Alamar Blue (resazurin) fluorescent dye for the assessment of mammalian cell cytotoxicity', *European Journal of Biochemistry* **267**, 5421–5426.
- Okamoto, K., Gotoh, N. and Nishino, T. (2002), 'Extrusion of Penem Antibiotics by Multicomponent Efflux Systems MexAB-OprM, MexCD-OprJ, and MexXY-OprM of *Pseudomonas aeruginosa*', *Antimicrobial Agents and Chemotherapy* **46**(8), 2696–2699.
- Oliver, J. D. (2005), 'The viable but nonculturable state in bacteria', *Journal of Microbiology* **43**, 93–100.
- O'Neill, J. (2016), 'Tackling drug-resistant infections globally: Final report and recommendations', *The Review on Antimicrobial Resistance* .
- Orrett, F. A. (2000), 'Fatal multi-resistant *Pseudomonas aeruginosa* septicemia outbreak in a neonatal intensive care unit in Trinidad', *Ethiopian Medical Journal* **38**, 85–91.
- O'Toole, G. A. (2011), 'Microtiter dish biofilm formation assay', *JoVE* (47).
- O'Toole, G. A. and Kolter, R. (1998), 'Flagellar and twitching motility are necessary for *Pseudomonas aeruginosa* biofilm development', *Molecular Microbiology* **30**(2), 295–304.



## LIST OF REFERENCES

---

- Otter, J. A., Yezli, S. and French, G. L. (2011), 'The role played by contaminated surfaces in the transmission of nosocomial pathogens', *Infection Control and Hospital Epidemiology* **32**(7), 687–699.
- Ottow, J. C. (1975), 'Ecology, physiology, and genetics of fimbriae and pili.', *Annual Review of Microbiology* **29**, 79–108.
- O'Brien, T. J., Figueroa, W. and Welch, M. (2022), 'Decreased efficacy of antimicrobial agents in a polymicrobial environment', *ISME Journal*.
- Pal, C., Asiani, K., Arya, S., Rensing, C., Stekel, D. J., Larsson, D. G. J. and Hobman, J. L. (2017), 'Metal resistance and its association with antibiotic resistance.', *Advances in Microbial Physiology* **70**, 261–313.
- Pal, C., Bengtsson-Palme, J., Kristiansson, E. and Larsson, D. G. J. (2015), 'Co-occurrence of resistance genes to antibiotics, biocides and metals reveals novel insights into their co-selection potential', *BMC Genomics* **16**, 964.
- Panacek, A., Kvitek, L., Smekalova, M., Vecerova, R., Kolar, M., Roderova, M., Dycka, F., Sebela, M., Pucek, R., Tomanec, O. and Zboril, R. (2018), 'Bacterial resistance to silver nanoparticles and how to overcome it', *Nature Nanotechnology* **13**(1), 65–71.
- Panagea, S., Winstanley, C., Walshaw, M. J., Ledson, M. J. and Hart, C. A. (2005), 'Environmental contamination with an epidemic strain of *Pseudomonas aeruginosa* in a Liverpool cystic fibrosis centre, and study of its survival on dry surfaces', *Journal of Hospital Infection* **59**, 102–107.
- Pang, Z., Raudonis, R., Glick, B. R., Lin, T.-J. and Cheng, Z. (2019), 'Antibiotic resistance in *Pseudomonas aeruginosa*: mechanisms and alternative therapeutic strategies', *Biotechnology Advances* **37**(1), 177–192.

## LIST OF REFERENCES

---

- Papenfort, K. and Bassler, B. L. (2016), 'Quorum sensing signal-response systems in Gram-negative bacteria', *Nature Reviews Microbiology* **14**(9), 576–588.
- Parada, A. E., Needham, D. M. and Fuhrman, J. A. (2016), 'Every base matters: assessing small subunit rRNA primers for marine microbiomes with mock communities, time series and global field samples', *Environmental Microbiology* **18**(5), 1403–1414.
- Park, S. C., Hardik, P., Kasi, V., Nicole, S., Barry Katie, E., Kotay Shireen, M., Sarah, D., Peto Timothy E., A., Crook Derrick, W., Sarah, W. A., Mathers Amy, J. and Dozois Charles, M. (2020), 'Risk Factors Associated with Carbapenemase-Producing Enterobacterales (CPE) Positivity in the Hospital Wastewater Environment', *Applied and Environmental Microbiology* **86**(24), e01715–20.
- Paterson, D. L. and Bonomo, R. A. (2005), 'Extended-Spectrum Beta-Lactamases: a Clinical Update', *Clinical Microbiology Reviews* **18**(4), 657–686.
- Pendleton, J. N., Gorman, S. P. and Gilmore, B. F. (2013), 'Clinical relevance of the ESKAPE pathogens', *Expert Review of Anti-infective Therapy* **11**(3), 297–308.
- Pereira, M. I. A., Monteiro, C. A. P., de Oliveira, W. F., Santos, B. S., Fontes, A. and Cabral Filho, P. E. (2020), 'Resazurin-Based Assay to Evaluate Cell Viability After Quantum Dot Interaction', *Methods in Molecular Biology* **2135**, 213–221.
- Perrot, S., Dutertre-Catella, H., Martin, C., Rat, P. and Warnet, J.-M. (2003),

## LIST OF REFERENCES

---

- 'Resazurin Metabolism Assay Is a New Sensitive Alternative Test in Isolated Pig Cornea', *Toxicological Sciences* **72**(1), 122–129.
- Petrochenko, P. E., Zheng, J., Casey, B. J., Bayati, M. R., Narayan, R. J. and Goering, P. L. (2017), 'Nanosilver-PMMA composite coating optimized to provide robust antibacterial efficacy while minimizing human bone marrow stromal cell toxicity', *Toxicology in Vitro* **44**, 248–255.
- Pirzadian, J., Harteveld, S. P., Ramdutt, S. N., van Wamel, W. J. B., Klaassen, C. H. W., Vos, M. C. and Severin, J. A. (2020), 'Novel use of culturomics to identify the microbiota in hospital sink drains with and without persistent VIM-positive *Pseudomonas aeruginosa*', *Scientific Reports* **10**(1), 17052.
- Pisithkul, T., Schroeder, J. W., Trujillo, E. A., Yeesin, P., Stevenson, D. M., Chaiamarit, T., Coon, J. J., Wang, J. D. and Amador-Noguez, D. (2019), 'Metabolic Remodeling during Biofilm Development of *Bacillus subtilis*', *mBio* **10**.
- Poretsky, R., Rodriguez-R, L. M., Luo, C., Tsementzi, D. and Konstantinidis, K. T. (2014), 'Strengths and Limitations of 16S rRNA Gene Amplicon Sequencing in Revealing Temporal Microbial Community Dynamics', *PLOS ONE* **9**(4), 1–12.
- Potter, P. M., Navratilova, J., Rogers, K. R. and Al-Abed, S. R. (2019), 'Transformation of silver nanoparticle consumer products during simulated usage and disposal', *Environmental Science: Nano* **6**, 592–598.
- Prokhorov, K., Aleksandrova, D., Sagitova, E., Nikolaeva, G., Vlasova, T., Pashinin, P., Jones, C. and Shilton, S. (2016), 'Raman spectroscopy evaluation of polyvinylchloride structure', *Journal of Physics* **691**.

## LIST OF REFERENCES

---

- Puckett, S. D., Taylor, E., Raimondo, T. and Webster, T. J. (2010), 'The relationship between the nanostructure of titanium surfaces and bacterial attachment.', *Biomaterials* **31**, 706–713.
- Pulit-Prociak, J. and Banach, M. (2016), 'Silver nanoparticles – a material of the future...?', *Open Chemistry* **14**(1), 76–91.
- Putonti, C., Polley, N. and Castignetti, D. (2018), 'Draft Genome Sequence of an Active Heterotrophic Nitrifier-Denitrifier, *Cupriavidus pauculus* UM1', *Genome Announcements* **6**(6).
- Pöntinen, A. K., Top, J., Arredondo-Alonso, S., Tonkin-Hill, G., Freitas, A. R., Novais, C., Gladstone, R. A., Pesonen, M., Meneses, R., Pesonen, H., Lees, J. A., Jamrozny, D., Bentley, S. D., Lanza, V. F., Torres, C., Peixe, L., Coque, T. M., Parkhill, J., Schürch, A. C., Willems, R. J. L. and Corander, J. (2021), 'Apparent nosocomial adaptation of *Enterococcus faecalis* predates the modern hospital era', *Nature Communications* **12**(1), 15–23.
- Quick, J., Cumley, N., Wearn, C. M., Niebel, M., Constantinidou, C., Thomas, C. M., Pallen, M. J., Moïemen, N. S., Bamford, A., Oppenheim, B. and Loman, N. J. (2014), 'Seeking the source of *Pseudomonas aeruginosa* infections in a recently opened hospital: an observational study using whole-genome sequencing.', *BMJ open* **4**.
- Radford, D. S., Kihlken, M. A., Borrelly, G. P., Harwood, C. R., Le Brun, N. E. and Cavet, J. S. (2003), 'CopZ from *Bacillus subtilis* interacts *in vivo* with a copper exporting CPx-type ATPase CopA', *FEMS Microbiology Letters* **220**(1), 105–112.
- Rai, M., Yadav, A. and Gade, A. (2009), 'Silver nanoparticles as a new generation of antimicrobials', *Biotechnology Advances* **27**(1), 76–83.

## LIST OF REFERENCES

---

- Ramirez, M., Obrzydowski, J., Ayers, M., Virparia, S., Wang, M., Stefan, K., Linchangco, R. and Castignetti, D. (2014), 'Pyruvic oxime nitrification and copper and nickel resistance by a *Cupriavidus pauculus*, an active heterotrophic nitrifier-denitrifier', *The Scientific World Journal* .
- Rampado, R., Crotti, S., Caliceti, P., Pucciarelli, S. and Agostini, M. (2020), 'Recent Advances in Understanding the Protein Corona of Nanoparticles and in the Formulation of "Stealthy" Nanomaterials', *Frontiers in Bioengineering and Biotechnology* **8**, 166.
- Randall, C. P., Gupta, A., Jackson, N., Busse, D. and O'Neill, A. J. (2015), 'Silver resistance in Gram-negative bacteria: a dissection of endogenous and exogenous mechanisms', *The Journal of Antimicrobial Chemotherapy* **70**(4), 1037–1046.
- Rashid, M. (2006), 'A decade of adult intensive care unit design: a study of the physical design features of the best-practice examples.', *Critical Care Nursing Quarterly* **29**, 282–311.
- Rawat, D. and Nair, D. (2010), 'Extended-spectrum Beta-lactamases in Gram Negative Bacteria', *Journal of Global Infectious Diseases* **2**(3), 263–274.
- Rawson, T. M., Moore, L. S. P., Castro-Sanchez, E., Charani, E., Davies, F., Satta, G., Ellington, M. J. and Holmes, A. H. (2020), 'COVID-19 and the potential long-term impact on antimicrobial resistance', *Journal of Antimicrobial Chemotherapy* **75**(7), 1681–1684.
- Regev-Yochay, G., Smollan, G., Tal, I., Pinas Zade, N., Haviv, Y., Nudelman, V., Gal-Mor, O., Jaber, H., Zimlichman, E., Keller, N. and Rahav, G. (2018), 'Sink traps as the source of transmission of OXA-48–producing *Ser-*

## LIST OF REFERENCES

---

- ratia marcescens* in an intensive care unit', *Infection Control & Hospital Epidemiology* **39**(11), 1307–1315.
- Rhame, F. (1998), The inanimate environment, in J. Bennett and P. Brachmann, eds, 'Hospital Infection', Lipincott-Raven, Philadelphia, pp. 299–324.
- Rice, L. B. (2010), 'Progress and challenges in implementing the research on ESKAPE pathogens', *Infection Control and Hospital Epidemiology* **31**, 7–10.
- Rice, L. B. (2018), 'Antimicrobial stewardship and antimicrobial resistance.', *The Medical Clinics of North America* **102**, 805–818.
- Roberts, A. P. (2020), 'Swab and Send: a citizen science, antibiotic discovery project', *Future Science OA* .
- Roca Subirà, I., Espinal, P., Vila-Farrés, X. and Vila Estapé, J. (2012), 'The *Acinetobacter baumannii* Oxymoron: Commensal Hospital Dweller Turned Pan-Drug-Resistant Menace', *Frontiers in Microbiology* **3**.
- Rodrigues, D. C., Valderrama, P., Wilson, T. G., Palmer, K., Thomas, A., Sridhar, S., Adapalli, A., Burbano, M. and Wadhvani, C. (2013), 'Titanium Corrosion Mechanisms in the Oral Environment: A Retrieval Study', *Materials* **6**(11), 5258–5274.
- Rosenthal, V. D., Bijie, H., Maki, D. G., Mehta, Y., Apisarnthanarak, A., Medeiros, E. A., Leblebicioglu, H., Fisher, D., Álvarez Moreno, C., Khader, I. A., Del Rocío González Martínez, M., Cuellar, L. E., Navoa-Ng, J. A., Abouqal, R., Guanche Garcell, H., Mitrev, Z., Pirez García, M. C., Hamdi, A., Dueñas, L., Cancel, E., Gurskis, V., Rasslan, O., Ahmed, A., Kanj, S. S., Ugalde, O. C., Mapp, T., Raka, L., Yuet Meng, C., Thu, L. T. A., Ghazal, S., Gikas, A., Narváez, L. P., Mejía, N., Hadjieva, N., Gamar Elanbya, M. O.,

## LIST OF REFERENCES

---

- Guzmán Sirtt, M. E. and Jayatilleke, K. (2012), 'International Nosocomial Infection Control Consortium (INICC) report, data summary of 36 countries, for 2004-2009', *American Journal of Infection Control* **40**(5), 396–407.
- Roux, D., Aubier, B., Cochard, H., Quentin, R. and van der Mee-Marquet, N. (2013), 'Contaminated sinks in intensive care units: an underestimated source of extended-spectrum beta-lactamase-producing *Enterobacteriaceae* in the patient environment', *Journal of Hospital Infection* **85**(2), 106–111.
- Rubin, B. E. R., Gibbons, S. M., Kennedy, S., Hampton-Marcell, J., Owens, S. and Gilbert, J. A. (2013), 'Investigating the impact of storage conditions on microbial community composition in soil samples', *PLoS One* **8**.
- Rumbaugh, K. P. and Sauer, K. (2020), 'Biofilm dispersion', *Nature Reviews Microbiology* **18**(10), 571–586.
- Rummel, C. D., Lechtenfeld, O. J., Kallies, R., Benke, A., Herzsprung, P., Rynek, R., Wagner, S., Potthoff, A., Jahnke, A. and Schmitt-Jansen, M. (2021), 'Conditioning Film and Early Biofilm Succession on Plastic Surfaces', *Environmental Science and Technology* **55**(16), 11006–11018.
- Sadiq, F. A., Flint, S., Li, Y., Liu, T., Lei, Y., Sakandar, H. A. and He, G. (2017), 'New mechanistic insights into the motile-to-sessile switch in various bacteria with particular emphasis on *Bacillus subtilis* and *Pseudomonas aeruginosa*: a review.', *Biofouling* **33**, 306–326.
- Salaie, R. N., Besinis, A., Le, H., Tredwin, C. and Handy, R. D. (2020), 'The biocompatibility of silver and nanohydroxyapatite coatings on titanium dental implants with human primary osteoblast cells', *Materials Science and Engineering: C* **107**.

## LIST OF REFERENCES

---

- Salonen, A., Nikkilä, J., Jalanka-Tuovinen, J., Immonen, O., Rajilić-Stojanović, M., Kekkonen, R. A., Palva, A. and de Vos, W. M. (2010), 'Comparative analysis of fecal DNA extraction methods with phylogenetic microarray: effective recovery of bacterial and archaeal DNA using mechanical cell lysis.', *Journal of Microbiological Methods* **81**, 127–134.
- Sandbakken, E. T., Witsø, E., Sporsheim, B., Egeberg, K. W., Foss, O. A., Hoang, L., Bjerkan, G., Løseth, K. and Bergh, K. (2020), 'Highly variable effect of sonication to dislodge biofilm-embedded *Staphylococcus epidermidis* directly quantified by epifluorescence microscopy: an *in vitro* model study', *Journal of Orthopaedic Surgery and Research* **15**(1), 522.
- Sarker, S. D., Nahar, L. and Kumarasamy, Y. (2007), 'Microtitre plate-based antibacterial assay incorporating resazurin as an indicator of cell growth, and its application in the *in vitro* antibacterial screening of phytochemicals', *Methods* **42**(4), 321–324.
- Sarria, J. C., Vidal, A. M. and Kimbrough, Robert C., I. I. I. (2001), 'Infections Caused by *Kluyvera* Species in Humans', *Clinical Infectious Diseases* **33**(7), 69–74.
- Sayes, C. M., Wahi, R., Kurian, P. A., Liu, Y., West, J. L., Ausman, K. D., Warheit, D. B. and Colvin, V. L. (2006), 'Correlating nanoscale titania structure with toxicity: a cytotoxicity and inflammatory response study with human dermal fibroblasts and human lung epithelial cells.', *Toxicological Sciences* **92**, 174–185.
- Scheeren Brum, R., Apaza-Bedoya, K., Labes, L. G., Volpato, C. A. M., Pimenta, A. L. and Benfatti, C. A. M. (2021), 'Early Biofilm Formation on Rough



## LIST OF REFERENCES

---

- and Smooth Titanium Specimens: a Systematic Review of Clinical Studies', *Journal of Oral & Maxillofacial Research* **12**.
- Scheper, H., Wubbolts, J. M., Verhagen, J. A. M., de Visser, A. W., van der Wal, R. J. P., Visser, L. G., de Boer, M. G. J. and Nibbering, P. H. (2021), 'SAAP-148 Eradicates MRSA Persists Within Mature Biofilm Models Simulating Prosthetic Joint Infection', *Frontiers in Microbiology* **12**, 99.
- Schmalenberger, A., Schwieger, F. and Tebbe, C. C. (2001), 'Effect of primers hybridizing to different evolutionarily conserved regions of the small-subunit rRNA gene in PCR-based microbial community analyses and genetic profiling.', *Applied and Environmental Microbiology* **67**, 3557–3563.
- Schreurs, W. J. and Rosenberg, H. (1982), 'Effect of silver ions on transport and retention of phosphate by *Escherichia coli*', *Journal of Bacteriology* **152**(1), 7–13.
- Schuster, M., Joseph Sexton, D., Diggle, S. P. and Peter Greenberg, E. (2013), 'Acyl-Homoserine Lactone Quorum Sensing: From Evolution to Application', *Annual Review of Microbiology* **67**(1), 43–63.
- Seara, N., Oteo, J., Carrillo, R., Pérez-Blanco, V., Mingorance, J., Gómez-Gil, R., Herruzo, R., Pérez-Vázquez, M., Astray, J., García-Rodríguez, J., Ruiz-Velasco, L. M., Campos, J., de Burgos, C. and Ruiz-Carrascoso, G. (2015), 'Interhospital spread of NDM-7-producing *Klebsiella pneumoniae* belonging to ST437 in Spain', *International Journal of Antimicrobial Agents* **46**, 169–173.
- Seed, K. D. and Dennis, J. J. (2008), 'Development of *Galleria mellonella* as an Alternative Infection Model for the *Burkholderia cepacia* Complex', *Infection & Immunity* **76**(3), 1267–1275.

## LIST OF REFERENCES

---

- Seong, M. and Lee, D. G. (2017), 'Silver Nanoparticles Against *Salmonella enterica* Serotype Typhimurium: Role of Inner Membrane Dysfunction', *Current Microbiology* **74**(6), 661–670.
- Shobo, C. O., Essack, S. Y. and Bester, L. A. (2022), 'Enterococcal contamination of hospital environments in KwaZulu-Natal, South Africa', *Journal of Applied Microbiology* **132**, 654–664.
- Shukla, S. K. and Rao, T. S. (2017), 'An improved crystal violet assay for biofilm quantification in 96-well microtitre plate', *bioRxiv* .
- Sichtig, H., Minogue, T., Yan, Y., Stefan, C., Hall, A., Tallon, L., Sadzewicz, L., Nadendla, S., Klimke, W., Hatcher, E., Shumway, M., Aldea, D. L., Allen, J., Koehler, J., Slezak, T., Lovell, S., Schoepp, R. and Scherf, U. (2019), 'FDA-ARGOS is a database with public quality-controlled reference genomes for diagnostic use and regulatory science', *Nature Communications* **10**(1), 3313.
- Silverman, J. D., Bloom, R. J., Jiang, S., Durand, H. K., Dallow, E., Mukherjee, S. and David, L. A. (2021), 'Measuring and mitigating PCR bias in microbiota datasets', *PLOS Computational Biology* **17**(7), 1–17.
- Sim, W., Barnard, R. T., Blaskovich, M. A. T. and Ziora, Z. M. (2018), 'Antimicrobial silver in medicinal and consumer applications: A patent review of the past decade (2007-2017).', *Antibiotics (Basel, Switzerland)* **7**.
- Singh, S., Singh, S. K., Chowdhury, I. and Singh, R. (2017), 'Understanding the mechanism of bacterial biofilms resistance to antimicrobial agents', *The Open Microbiology Journal* **11**, 53–62.
- Sogin, M. L., Morrison, H. G., Huber, J. A., Mark Welch, D., Huse, S. M., Neal,

## LIST OF REFERENCES

---

- P. R., Arrieta, J. M. and Herndl, G. J. (2006), 'Microbial diversity in the deep sea and the underexplored "rare biosphere"', *PNAS* **103**, 12115–12120.
- Soothill, J. S. (2016), 'Carbapenemase-bearing *Klebsiella* spp. in sink drains: investigation into the potential advantage of copper pipes.', *Journal of Hospital Infection* **93**, 152–4.
- Soucy, S. M., Huang, J. and Gogarten, J. P. (2015), 'Horizontal gene transfer: building the web of life', *Nature Reviews Genetics* **16**(8), 472–482.
- Starlander, G. and Melhus, A. (2012), 'Minor outbreak of extended-spectrum beta lactamase-producing *Klebsiella pneumoniae* in an intensive care unit due to a contaminated sink', *Journal of Hospital Infection* **82**, 122–124.
- Stebounova, L. V., Adamcakova-Dodd, A., Kim, J. S., Park, H., O'Shaughnessy, P. T., Grassian, V. H. and Thorne, P. S. (2011), 'Nanosilver induces minimal lung toxicity or inflammation in a subacute murine inhalation model', *Particle and Fibre Toxicology* **8**(1), 5.
- Sternberg, C. and Tolker-Nielsen, T. (2006), 'Growing and Analyzing Biofilms in Flow Cells', *Current Protocols in Microbiology* (1).
- Stjärne Aspelund, A., Sjöström, K., Olsson Liljequist, B., Mörgelin, M., Melander, E. and Pålman, L. I. (2016), 'Acetic acid as a decontamination method for sink drains in a nosocomial outbreak of metallo- $\beta$ -lactamase-producing *Pseudomonas aeruginosa*.', *Journal of Hospital Infection* **94**, 13–20.
- Stovall, S. H., Wisdom, C., McKamie, W., Ware, W., Dedman, H. and Fiser, R. T. (2010), 'Nosocomial transmission of *Cupriavidus pauculus* during extracorporeal membrane oxygenation', *ASAIO Journal* **56**(5), 486–487.

## LIST OF REFERENCES

---

- Sutterlin, S., Edquist, P., Sandegren, L., Adler, M., Tangden, T., Drobni, M., Olsen, B. and Melhus, A. (2014), 'Silver resistance genes are overrepresented among *Escherichia coli* isolates with CTX-M production', *Applied and Environmental Microbiology* **80**(22), 6863–6869.
- Suzuki, M. T. and Giovannoni, S. J. (1996), 'Bias caused by template annealing in the amplification of mixtures of 16S rRNA genes by PCR', *Applied and Environmental Microbiology* **62**(2), 625–630.
- Sydnor, E. R. M. and Perl, T. M. (2011), 'Hospital epidemiology and infection control in acute-care settings', *Clinical Microbiology Reviews* **24**, 141–173.
- Szunerits, S. and Boukherroub, R. (2016), 'Antibacterial activity of graphene-based materials', *Journal of Materials Chemistry B* **4**(43), 6892–6912.
- Takahashi, S., Tomita, J., Nishioka, K., Hisada, T. and Nishijima, M. (2014), 'Development of a prokaryotic universal primer for simultaneous analysis of Bacteria and Archaea using next-generation sequencing', *PloS One* **9**(8), e105592.
- Tavares-Carreón, F., Fathy Mohamed, Y., Andrade, A. and Valvano, M. A. (2016), 'ArnT proteins that catalyze the glycosylation of lipopolysaccharide share common features with bacterial N-oligosaccharyltransferases', *Glycobiology* **26**, 286–300.
- Tekçe, N., Fidan, S., Tuncer, S., Kara, D. and Demirci, M. (2018), 'The effect of glazing and aging on the surface properties of CAD/CAM resin blocks', *The Journal of Advanced Prosthodontics* **10**, 50.
- Tenzer, S., Docter, D., Kuharev, J., Musyanovych, A., Fetz, V., Hecht, R., Schlenk, F., Fischer, D., Kiouptsi, K., Reinhardt, C., Landfester, K., Schild,

## LIST OF REFERENCES

---

- H., Maskos, M., Knauer, S. K. and Stauber, R. H. (2013), 'Rapid formation of plasma protein corona critically affects nanoparticle pathophysiology', *Nature Nanotechnology* **8**(10), 772–781.
- Thi, M. T. T., Wibowo, D. and Rehm, B. H. (2020), '*Pseudomonas aeruginosa* biofilms', *International Journal of Molecular Sciences* **21**(22).
- Travnickova, E., Mikula, P., Oprsal, J., Bohacova, M., Kubac, L., Kimmer, D., Soukupova, J. and Bittner, M. (2019), 'Resazurin assay for assessment of antimicrobial properties of electrospun nanofiber filtration membranes', *AMB Express* **9**(1), 183.
- Tulve, N. S., Stefaniak, A. B., Vance, M. E., Rogers, K., Mwilu, S., LeBouf, R. F., Schwegler-Berry, D., Willis, R., Thomas, T. A. and Marr, L. C. (2015), 'Characterization of silver nanoparticles in selected consumer products and its relevance for predicting children's potential exposures', *International Journal of Hygiene and Environmental Health* **218**(3), 345–357.
- Tuon, F. F., Dantas, L. R., Suss, P. H. and Tasca Ribeiro, V. S. (2022), 'Pathogenesis of the *Pseudomonas aeruginosa* Biofilm: A Review.', *Pathogens* **11**.
- Tyler, A. D., Mataseje, L., Urfano, C. J., Schmidt, L., Antonation, K. S., Mulvey, M. R. and Corbett, C. R. (2018), 'Evaluation of Oxford Nanopore's MinION Sequencing Device for Microbial Whole Genome Sequencing Applications', *Scientific Reports* **8**(1), 10931.
- Ullah Khan, S., Saleh, T. A., Wahab, A., Khan, M. H. U., Khan, D., Ullah Khan, W., Rahim, A., Kamal, S., Ullah Khan, F. and Fahad, S. (2018), 'Nanosilver: new ageless and versatile biomedical therapeutic scaffold.', *International Journal of Nanomedicine* **13**, 733–762.

## LIST OF REFERENCES

---

- Uneputty, A., Dávila-Lezama, A., Garibo, D., Oknianska, A., Bogdanchikova, N., Hernández-Sánchez, J. F. and Susarrey-Arce, A. (2022), 'Strategies applied to modify structured and smooth surfaces: A step closer to reduce bacterial adhesion and biofilm formation', *Colloid and Interface Science Communications* **46**.
- Vandamme, P. and Coenye, T. (2004), 'Taxonomy of the genus *Cupriavidus*: a tale of lost and found', *International Journal of Systematic and Evolutionary Microbiology* **54**, 2285–2289.
- Vaneechoutte, M., Kämpfer, P., De Baere, T., Falsen, E. and Verschraegen, G. (2004), '*Wautersia* gen. nov., a novel genus accommodating the phylogenetic lineage including *Ralstonia eutropha* and related species, and proposal of *Ralstonia* [*Pseudomonas*] *syzygii* (Roberts et al. 1990) comb. nov.', *International Journal of Systematic and Evolutionary Microbiology* .
- Volling, C., Ahangari, N., Bartoszko, J. J., Coleman, B. L., Garcia-Jeldes, F., Jamal, A. J., Johnstone, J., Kandel, C., Kohler, P., Maltezou, H. C., Maze dit Mieusement, L., McKenzie, N., Mertz, D., Monod, A., Saeed, S., Shea, B., Stuart, R. L., Thomas, S., Uleryk, E. and McGeer, A. (2020), 'Are Sink Drainage Systems a Reservoir for Hospital-Acquired Gammaproteobacteria Colonization and Infection? A Systematic Review', *Open Forum Infectious Diseases* **8**(2).
- von Rozycki, T. and Nies, D. H. (2009), '*Cupriavidus metallidurans*: evolution of a metal-resistant bacterium', *Antonie Van Leeuwenhoek* **96**(2), 115–39.
- Walker, J., Jhutti, A., Parks, S., Willis, C., Copley, V., Turton, J., Hoffman, P. and Bennett, A. (2014), 'Investigation of healthcare-acquired infections as-

## LIST OF REFERENCES

---

- sociated with *Pseudomonas aeruginosa* biofilms in taps in neonatal units in Northern Ireland', *Journal of Hospital Infection* **86**(1), 16–23.
- Walker, J. and Moore, G. (2015), '*Pseudomonas aeruginosa* in hospital water systems: biofilms, guidelines, and practicalities', *Journal of Hospital Infection* **89**(4), 324–327.
- Wand, M. E., Bock, L. J., Turton, J. F., Nugent, P. G. and Sutton, J. M. (2012), '*Acinetobacter baumannii* virulence is enhanced in *Galleria mellonella* following biofilm adaptation', *Journal of Medical Microbiology* **61**(4), 470–477.
- Wang, H., Jiang, Y., Zhang, Y., Zhang, Z., Yang, X., Ali, M. A., Fox, E. M., Gobius, K. S. and Man, C. (2018), 'Silver nanoparticles: A novel antibacterial agent for control of *Cronobacter sakazakii*', *Journal of Dairy Science* .
- Wang, L., Hu, C. and Shao, L. (2017), 'The antimicrobial activity of nanoparticles: present situation and prospects for the future', *International Journal of Nanomedicine* **12**, 1227–1249.
- Watanabe, T., Yamazoe, A., Hosoyama, A., Fujihara, H., Suenaga, H., Hirose, J., Futagami, T., Goto, M., Kimura, N. and Furukawa, K. (2015), 'Draft Genome Sequence of *Cupriavidus pauculus* Strain KF709, a Biphenyl-Utilizing Bacterium Isolated from Biphenyl-Contaminated Soil', *Genome Announcements* **3**(2).
- Webber, M. A., Whitehead, R. N., Mount, M., Loman, N. J., Pallen, M. J. and Piddock, L. J. V. (2015), 'Parallel evolutionary pathways to antibiotic resistance selected by biocide exposure', *Journal of Antimicrobial Chemotherapy* **70**(8), 2241–2248.

## LIST OF REFERENCES

---

- Weber, D. J., Rutala, W. A., Miller, M. B., Huslage, K. and Sickbert-Bennett, E. (2010), 'Role of hospital surfaces in the transmission of emerging health care-associated pathogens: Norovirus, *Clostridium difficile*, and *Acinetobacter* species', *American Journal of Infection Control* **38**(5), 25–33.
- Weigand, M. R., Ashbolt, N. J., Konstantinidis, K. T. and Santo Domingo, J. W. (2014), 'Genome Sequencing Reveals the Environmental Origin of Enterococci and Potential Biomarkers for Water Quality Monitoring', *Environmental Science & Technology* **48**(7), 3707–3714.
- Weinbren, M., Inkster, T. and Lafferty, F. (2021), 'Drains and the periphery of the water system – what do you do when the guidance is outdated?', *Infection Prevention in Practice* **3**(4), 100179.
- Weller, J., Vasudevan, P., Kreikemeyer, B., Ekatt, K., Jackszis, M., Springer, A., Chatzivasileiou, K. and Lang, H. (2022), 'The role of bacterial corrosion on recolonization of titanium implant surfaces: An *in vitro* study', *Clinical Implant Dentistry and Related Research* .
- Westwood, J. C., Mitchell, M. A. and Legacé, S. (1971), 'Hospital sanitation: the massive bacterial contamination of the wet mop', *Applied Microbiology* **21**, 693–697.
- Wick, R. R., Judd, L. M., Gorrie, C. L. and Holt, K. E. (2017a), 'Completing bacterial genome assemblies with multiplex MinION sequencing', *Microbial Genomics* **3**(10).
- Wick, R. R., Judd, L. M., Gorrie, C. L. and Holt, K. E. (2017b), 'Unicycler: Resolving bacterial genome assemblies from short and long sequencing reads', *PLOS Computational Biology* **13**(6).



## LIST OF REFERENCES

---

- Williams, D., Fothergill, J. L., Evans, B., Caples, J., Haldenby, S., Walshaw, M. J., Brockhurst, M. A., Winstanley, C. and Paterson, S. (2018), 'Transmission and lineage displacement drive rapid population genomic flux in cystic fibrosis airway infections of a *Pseudomonas aeruginosa* epidemic strain', *Microbial Genomics* **4**(3).
- Withey, Z., Goodall, T., MacIntyre, S. and Gweon, H. S. (2021), 'Characterization of communal sink drain communities of a university campus', *Environmental DNA* **3**(5), 901–911.
- Wolf, I., Bergervoet, P. W., Sebens, F. W., van den Oever, H. L., Savelkoul, P. H. and van der Zwet, W. C. (2014), 'The sink as a correctable source of extended-spectrum beta-lactamase contamination for patients in the intensive care unit', *Journal of Hospital Infection* **87**(2), 126–130.
- Wong, W. C., Dudinsky, L. A., Garcia, V. M., Ott, C. M. and Castro, V. A. (2010), 'Efficacy of various chemical disinfectants on biofilms formed in spacecraft potable water system components', *Biofouling* **26**(5), 583–586.
- Wood, D. E., Lu, J. and Langmead, B. (2019), 'Improved metagenomic analysis with Kraken 2', *Genome Biology* **20**(1), 257.
- Woodford, N. and Ellington, M. J. (2007), 'The emergence of antibiotic resistance by mutation', *Clinical Microbiology and Infection* **13**(1), 5–18.
- World Health Organization (2003), 'Consensus document on the epidemiology of severe acute respiratory syndrome (SARS)'.
- World Health Organization (2011), 'Report on the burden of endemic health care-associated infection worldwide'.
- World Health Organization (2021), 'Antimicrobial resistance fact sheet'.

## LIST OF REFERENCES

---

- Xie, Y., He, Y., Irwin, P. L., Jin, T. and Shi, X. (2011), 'Antibacterial Activity and Mechanism of Action of Zinc Oxide Nanoparticles against *Campylobacter jejuni*', *Applied and Environmental Microbiology* **77**(7), 2325.
- Xu, G., Shen, X., Dai, L., Ran, Q., Ma, P. and Cai, K. (2017), 'Reduced bacteria adhesion on octenidine loaded mesoporous silica nanoparticles coating on titanium substrates', *Materials Science and Engineering* **70**, 386–395.
- Xu, H. S., Roberts, N., Singleton, F. L., Attwell, R. W., Grimes, D. J. and Colwell, R. R. (1982), 'Survival and viability of nonculturable *Escherichia coli* and *Vibrio cholerae* in the estuarine and marine environment', *Microbial Ecology* **8**(4), 313–323.
- Xu, Z., He, Z., Song, Y., Fu, X., Rommel, M., Luo, X., Hartmaier, A., Zhang, J. and Fang, F. (2018), 'Topic Review: Application of Raman Spectroscopy Characterization in Micro/Nano-Machining.', *Micromachines* **9**.
- Xue, M., Wu, L., He, Y., Liang, H. and Wen, C. (2018), 'Biases during DNA extraction affect characterization of the microbiota associated with larvae of the Pacific white shrimp, *Litopenaeus vannamei*', *PeerJ* **6**, 5257.
- Yahya, R., Alyousef, W., Omara, A., Alamoudi, S., Alshami, A. and Abdalhamid, B. (2017), 'First case of pneumonia caused by *Cupriavidus pauculus* in an infant in the Gulf Cooperation Council', *The Journal of Infection in Developing Countries* **11**(02).
- Yang, L., Liu, Y., Wu, H., Hóiby, N., Molin, S. and Song, Z.-j. (2011), 'Current understanding of multi-species biofilms', *International Journal of Oral Science* **3**, 74–81.

## LIST OF REFERENCES

---

- Yano, R., Shimoda, T., Watanabe, R., Kuroki, Y., Okubo, T., Nakamura, S., Matsuo, J., Yoshimura, S. and Yamaguchi, H. (2017), 'Diversity changes of microbial communities into hospital surface environments', *Journal of Infection and Chemotherapy* **23**(7), 439–445.
- Yin, I. X., Zhang, J., Zhao, I. S., Mei, M. L., Li, Q. and Chu, C. H. (2020), 'The antibacterial mechanism of silver nanoparticles and its application in dentistry.', *International Journal of Nanomedicine* **15**, 2555–2562.
- Yu, Z., Tang, J., Khare, T. and Kumar, V. (2020), 'The alarming antimicrobial resistance in ESKAPEE pathogens: Can essential oils come to the rescue?', *Fitoterapia* **140**.
- Zapka, C., Leff, J., Henley, J., Tittl, J., Nardo, E. D., Butler, M., Griggs, R., Fierer, N., Edmonds-Wilson, S. and Clemente, J. C. (2017), 'Comparison of Standard Culture-Based Method to Culture-Independent Method for Evaluation of Hygiene Effects on the Hand Microbiome', *mBio* **8**(2).
- Zhang, C., Sun, R. and Xia, T. (2020), 'Adaption/resistance to antimicrobial nanoparticles: Will it be a problem?', *Nano Today* **34**.
- Zhang, X.-H., Ahmad, W., Zhu, X.-Y., Chen, J. and Austin, B. (2021), 'Viable but nonculturable bacteria and their resuscitation: implications for cultivating uncultured marine microorganisms', *Marine Life Science & Technology* **3**(2), 189–203.
- Zhao, J., Li, J., Schloss, P. D., Kalikin, L. M., Raymond, T. A., Petrosino, J. F., Young, V. B. and LiPuma, J. J. (2011), 'Effect of sample storage conditions on culture-independent bacterial community measures in cystic fibrosis sputum specimens', *Journal of Clinical Microbiology* **49**, 3717–3718.

## LIST OF REFERENCES

---

- Zheng, J.-x., Bai, B., Lin, Z.-w., Pu, Z.-y., Yao, W.-m., Chen, Z., Li, D.-y., Deng, X.-b., Deng, Q.-w. and Yu, Z.-j. (2018), 'Characterization of biofilm formation by *Enterococcus faecalis* isolates derived from urinary tract infections in China', *Journal of Medical Microbiology* **67**(1), 60–67.
- Zheng, S., Bawazir, M., Dhall, A., Kim, H.-E., He, L., Heo, J. and Hwang, G. (2021), 'Implication of surface properties, bacterial motility, and hydrodynamic conditions on bacterial surface sensing and their initial adhesion', *Frontiers in Bioengineering and Biotechnology* **9**.
- Zhou, F., Yu, T., Du, R., Fan, G., Liu, Y., Liu, Z., Xiang, J., Wang, Y., Song, B., Gu, X., Guan, L., Wei, Y., Li, H., Wu, X., Xu, J., Tu, S., Zhang, Y., Chen, H. and Cao, B. (2020), 'Clinical course and risk factors for mortality of adult inpatients with COVID-19 in Wuhan, China: a retrospective cohort study', *Lancet* **395**(10229), 1054–1062.
- Zhou, Z., Hu, B., Gao, X., Bao, R., Chen, M. and Li, H. (2016), 'Sources of sporadic *Pseudomonas aeruginosa* colonizations/infections in surgical ICUs: Association with contaminated sink trap', *Journal of Infection and Chemotherapy* **22**, 450–455.

*LIST OF REFERENCES*

---

# **Bound copies of published papers**

*LIST OF REFERENCES*

---

# Hospital sink traps as a potential source of the emerging multidrug-resistant pathogen *Cupriavidus pauculus*: characterization and draft genome sequence of strain MF1

James Butler<sup>1,\*</sup>, Sean D. Kelly<sup>2</sup>, Katie J. Muddiman<sup>2</sup>, Alexandros Besinis<sup>1,3</sup> and Mathew Upton<sup>2</sup>

## Abstract

**Introduction.** *Cupriavidus pauculus* is historically found in soil and water but has more recently been reported to cause human infection and death. Hospital sink traps can serve as a niche for bacterial persistence and a platform for horizontal gene transfer, with evidence of dissemination of pathogens in hospital plumbing systems driving nosocomial infection.

**Gap Statement.** This paper presents the first *C. pauculus* strain isolated from a hospital sink trap. There are only six genome assemblies available on NCBI for *C. pauculus*; two of these are PacBio/Illumina hybrids. This paper presents the first ONT/Illumina hybrid assembly, with five contigs. The other assemblies available consist of 37, 38, 111 and 227 contigs. This paper also presents data on biofilm formation and lethal dose in *Galleria mellonella*; there is little published information describing these aspects of virulence.

**Aim.** The aims were to identify the isolate found in a hospital sink trap, characterize its genome, and assess whether it could pose a risk to human health.

**Methodology.** The genome was sequenced, and a hybrid assembly of short and long reads produced. Antimicrobial susceptibility was determined by the broth microdilution method. Virulence was assessed by measuring *in vitro* biofilm formation compared to *Pseudomonas aeruginosa* and *in vivo* lethality in *Galleria mellonella* larvae.

**Results.** The isolate was confirmed to be a strain of *C. pauculus*, with a 6.8 Mb genome consisting of 6468 coding sequences and an overall G+C content of 63.9 mol%. The genome was found to contain 12 antibiotic resistance genes, 8 virulence factor genes and 33 metal resistance genes. The isolate can be categorized as resistant to meropenem, amoxicillin, amikacin, gentamicin and colistin, but susceptible to cefotaxime, cefepime, imipenem and ciprofloxacin. Clear biofilm formation was seen in all conditions over 72 h and exceeded that of *P. aeruginosa* when measured at 37 °C in R2A broth. Lethality in *G. mellonella* larvae over 48 h was relatively low.

**Conclusion.** The appearance of a multidrug-resistant strain of *C. pauculus* in a known pathogen reservoir within a clinical setting should be considered concerning. Further work should be completed to compare biofilm formation and *in vivo* virulence between clinical and environmental strains, to determine how easily environmental strains may establish human infection. Infection control teams and clinicians should be aware of the emerging nature of this pathogen and further work is needed to minimize the impact of contaminated hospital plumbing systems on patient outcomes.

Received 03 November 2021; Accepted 29 December 2021; Published 03 February 2022

**Author affiliations:** <sup>1</sup>School of Engineering, Computing and Mathematics, Faculty of Science and Engineering, University of Plymouth, Plymouth PL4 8AA, UK; <sup>2</sup>School of Biomedical Sciences, Faculty of Health, University of Plymouth, Plymouth PL4 8AA, UK; <sup>3</sup>Peninsula Dental School, Faculty of Health, University of Plymouth, Plymouth PL4 8AA, UK.

\*Correspondence: James Butler, james.butler@plymouth.ac.uk

**Keywords:** Sink trap; *Cupriavidus pauculus*; MF1; whole genome sequencing; *Galleria mellonella*; biofilm.

**Abbreviations:** ANI, average nucleotide identity; ARG, antibiotic resistance gene; bp, base pair; CBA, columbia blood agar; CV, crystal violet; EPS, extracellular polymeric substances; EUCAST, European Committee on Antimicrobial Susceptibility Testing; LD<sub>50</sub>, median lethal dose; MIC, minimum inhibitory concentration; MLST, multi-locus sequence typing; MRG, metal resistance gene; ONT, Oxford Nanopore Technologies; PBS, phosphate-buffered saline; R2A, Reasoner's 2A; RT, room temperature; TSB, tryptic soy broth; VF, virulence factor; WGS, whole genome sequencing.

This project has been deposited at DDBJ/ENA/GenBank under the accession JAIQWY000000000 within BioProject PRJNA762702. The version described in this paper is version JAIQWY010000000. The contig sequences can be found under accession numbers JAIQWY010000001–JAIQWY010000005. Raw sequence data have been deposited under accession numbers SRX13365403 and SRX13365404.

Four supplementary tables are available with the online version of this article.

001501 © 2022 The Authors



## INTRODUCTION

The genus *Cupriavidus* is a member of the family *Burkholderiaceae* and consists of Gram-negative peritrichously flagellated bacilli. *Cupriavidus* species are primarily environmental organisms found in soil [1–3] but have also been isolated from a wastewater treatment plant [4], a groundwater remediation system [5], a hydrotherapy pool [6], bottled mineral water [7], nebulization solutions [8], and even the International Space Station [9, 10]. Many historical isolates were first identified as ‘CDC Group IVc-2’, which was later classified as a *Ralstonia* species [11], then as *Wautersia* [12], before finally being transferred to the genus *Cupriavidus* [13]. Certain *Cupriavidus* species such as *Cupriavidus pauculus* are emerging as opportunistic pathogens of interest [14] with multiple case reports of infection in immunocompromised [15–19] and immunocompetent [20–23] people as well as in those with cystic fibrosis [24–26], with evidence of nosocomial transmission [27–29]. A comprehensive summary of bacteraemia caused by *Cupriavidus* species reported that *C. pauculus* accounted for the vast majority (87%) of 23 reported cases across different countries [28].

The susceptibility of epidemiologically unrelated *Cupriavidus* spp. clinical strains to 20 antibiotics has been characterized [30], revealing widespread resistance to amoxicillin, amoxicillin-clavulanate, temocillin and aztreonam, relatively low (23%) susceptibility to ceftazidime, and higher susceptibility to ceftriaxone and cefotaxime (74 and 82%, respectively). Mixed susceptibility to colistin was reported, which is significant as the *Cupriavidus* genus was initially described as being colistin-susceptible [31] but *C. metallidurans* was later found to exhibit high expression of aminoarabinose transferase (ArnT) [32], a colistin resistance determinant, and *C. gilardii* may have been the origin of the *mcr-5* gene [30, 33].

Sink traps (also known as U-bends or P-traps) are sections of wastewater plumbing systems (WPS), both domestic and commercial, designed to trap water and prevent unwanted flow of sewer gases into the sink and surrounding environment. Sinks are present in virtually all hospital wards and patient rooms to encourage best practice regarding hand hygiene [34, 35], however these sink traps become heavily colonized with pathogenic bacteria and are an important reservoir of pathogens causing nosocomial infections [36–40]. The formation of biofilms, which are refractory to disinfection and facilitate long-term persistence of bacteria, poses an additional concern [41]. As well as acting as a reservoir, sinks are points of direct pathogen dispersal when they are used as bacteria escape by droplets and aerosols [42–45], and bacteria can also be carried on airflows within plumbing systems even between different floors of a building [46]. Furthermore, due to the realistic nature of sinks being used as an occasional point of disposal of patient material, pharmaceuticals and/or disinfectants, their resident bacteria are exposed to a wide variety of chemical substances. One study of an intensive care unit found that only 4% of total sink-related behaviours could be categorized as hand-washing, and a total of 56 sink-related activities could be identified that introduced a variety of nutrients potentially promoting microbial growth in the sinks [47]. There is evidence to suggest that hospital effluent wastewater selects for antibiotic resistance [48], suggesting that surfaces in the WPS may become enriched with resistant bacteria and so WPS could be further thought of as a reservoir of resistance genes. These resistance genes can reside in various genera of hardy environmental organisms and sinks may provide a platform for horizontal gene transfer [49]. *C. pauculus* has previously been linked with clinical WPS: in one case a *C. pauculus* bacteraemia was linked to a contaminated hospital water system [50] while in another case a ‘pseudo-outbreak’ at an outpatient clinic was linked to rinsing culture swabs in tap water [51], however isolation of *C. pauculus* from a hospital sink trap has not previously been reported.

In this article, we report the annotated draft genome sequence of *C. pauculus* strain MF1 isolated from a sink trap in a UK hospital. We also report the isolate’s genotypic and phenotypic antimicrobial susceptibility profile, determination of median lethal dose in *Galleria mellonella* larvae, and biofilm formation compared to *Pseudomonas aeruginosa*.

## METHODS

### Sample collection and bacterial recovery

Sink traps ( $n=2$ ) were removed from sinks at a UK hospital in 2017 by hospital staff, sealed in individual sample bags, transferred to University of Plymouth laboratories, and stored at  $-20^{\circ}\text{C}$ . In 2020, sink traps were thawed to room temperature (RT) for 1 h before sampling with a sterile swab moistened with Dulbecco A PBS (Thermo Scientific Oxoid, UK). Swabs were placed in tubes containing 3 ml PBS, then rotated and vortexed. Suspensions were serially diluted tenfold to  $10^{-3}$  and all subsequent suspensions were spread plated in 100  $\mu\text{l}$  aliquots on columbia blood agar (CBA) composed of columbia agar (Sigma-Aldrich, MO, USA) with 5% ( $v/v$ ) defibrinated horse blood (Fisher Scientific, UK). All bacteriological media and PBS were sterilized by autoclaving at  $121^{\circ}\text{C}$  and 15 psi for 15 min. Agar plates were incubated at either  $20^{\circ}\text{C}$  or  $37^{\circ}\text{C}$  for up to 7 days.

### Gram stain

To visualize cell morphology, indicate cell-wall composition and ultimately aid in initial identification of the organism, a Gram stain was conducted. A few colonies of the isolate were emulsified in a small volume of sterile deionized water spread across a glass slide, allowed to dry to give a smear, and fixed by briefly passing through a Bunsen flame. The slide was stained for 1 min by flooding with crystal violet (CV) solution (Pro-Lab Diagnostics, UK), rinsed with tap water, then flooded with the mordant

Gram's iodine (Pro-Lab Diagnostics, UK) for 1 min before rinsing briefly again with tap water. The slide was then held on a slant while a few drops of the decolourizing agent 95% ethanol were added and rinsed off with tap water. Finally, the counterstain safranin (Pro-Lab Diagnostics, UK) was added for 1 min and rinsed off with tap water. The slide was blotted dry and visualized with a brightfield microscope.

### Strain identification by 16S rRNA gene sequencing

Identification was continued based on the 16S rRNA gene sequence. Genomic DNA was extracted from a pure culture using the DNeasy PowerSoil Kit (Qiagen, Germany), according to the manufacturer's instructions. This kit utilizes an initial bead-beating step to lyse cells, followed by binding to a silica membrane within a spin column in the presence of chaotropic salts, removal of contaminants, and finally elution of purified DNA from the membrane. The 16S rRNA gene was amplified by PCR in 50 µl reactions consisting of 25 µl DreamTaq Green 2× PCR Master Mix (Thermo Fisher Scientific, UK), 5 µl DNA template, 2.5 µl of each primer (Eurofins Genomics, Luxembourg) at 0.5 µM (27 f: 5'-AGA GTT TGA TCA TGG CTC A-3', 1492 r: 5'-TAC GGT TAC CTT GTT ACG ACT T-3'), and 15 µl Ambion nuclease-free water (Invitrogen, MA, USA). A positive control of a known bacterial DNA sample and a negative control of Ambion nuclease-free water were included in the place of the DNA template. The thermocycler programme was as follows: 5 min at 94 °C followed by 30 cycles of 30 s at 94 °C, 1 min at 52 °C, and 1.5 min at 72 °C, followed by 10 min at 72 °C. The presence and size of PCR products were confirmed by gel electrophoresis, running 5 µl of each PCR reaction mixture on a 1.5% agarose gel with SYBR Safe DNA Gel Stain (Invitrogen, MA, USA). PCR products were prepared for sequencing using the ExoSAP-IT PCR Product Cleanup Reagent (Thermo Fisher Scientific, UK) according to the manufacturer's instructions. Amplicon sequencing was completed by Biosearch Technologies (LGC Genomics, Germany), and sequences were analysed using Geneious Prime 2021.1.1 for macOS (<https://geneious.com>). The ends of the forward and reverse sequences were trimmed based on quality (error probability limit 0.01) and the sequences aligned using the MUSCLE algorithm (default settings) within Geneious Prime. The resulting consensus sequence was then used for a search using the Basic Local Alignment Search Tool (BLAST; <https://blast.ncbi.nlm.nih.gov/Blast.cgi>).

### Antimicrobial susceptibility testing

The guidelines provided by the European Committee on Antimicrobial Susceptibility Testing (EUCAST; <https://www.eucast.org>) were followed for completion of MIC assays by the broth microdilution method. All MIC assays were conducted in cation-adjusted Mueller–Hinton II broth (Sigma-Aldrich, MO, USA) in 96-well round-bottom polypropylene microplates (Corning, NY, USA) and results determined visually following 18±2 h static incubation at 37 °C. Antibiotics were purchased from Melford Laboratories (amikacin, amoxicillin, amoxicillin-clavulanate, cefotaxime, colistin), Sigma-Aldrich (ceftazidime, ciprofloxacin, doxycycline, erythromycin, meropenem), Carbosynth (imipenem, relebactam), Fisher Scientific (cefepime) and Lonza (gentamicin). Antibiotic stocks were prepared in sterile deionized water, except erythromycin, which was prepared in dimethyl sulfoxide, and stored at -20 °C until use. A 16:1 ratio of amoxicillin to relebactam was used, as previously reported [52]. Classification of the isolate's susceptibility to antibiotics was determined based on EUCAST breakpoints [53] using entries for *Pseudomonas* spp. as published previously [28, 30, 54], as well as PK-PD breakpoints which are not species-specific.

### Draft genome sequence determination

Illumina next-generation sequencing was provided by MicrobesNG (<https://microbesng.com>). The isolate was submitted in the form of cells harvested from an agar plate after streaking a single colony, suspended in a tube with cryopreservative (Microbank, Pro-Lab Diagnostics, UK). DNA extraction was completed by MicrobesNG using lysozyme, RNase A, proteinase K, and sodium dodecyl sulphate, and genomic DNA was purified using SPRI beads. Details of the DNA extraction, quantification and sequencing library preparation are available at <https://microbesng.com/microbesng-faq/>. Finally, reads were adapter-trimmed using Trimmomatic 0.30 with a sliding window quality cut-off of Q15.

Oxford Nanopore Technologies (ONT) MinION sequencing was employed to produce long reads to assist in genome assembly. Genomic DNA was isolated using the DNeasy Blood and Tissue Kit (Qiagen, Germany) with a modification made for Gram-negative bacteria according to the manufacturer's instructions; brief suspension in a lysis buffer (kit buffer ATL). Precautions were taken throughout to reduce shearing of high molecular weight DNA, including flicking tubes to mix rather than vortexing, use of wide bore pipette tips, avoidance of freeze–thaw cycles, and keeping tubes on ice. Extraction yield was quantified using the Qubit dsDNA HS Assay Kit (Invitrogen, MA, USA) and fluorometer (Thermo Fisher Scientific, UK), and purity was determined using a Nanodrop spectrophotometer (Thermo Fisher Scientific, UK). ONT sequencing was completed using the 1D Native barcoding genomic DNA protocol (SQK-LSK108) and EXP-NBD103 barcoding kit on an R9.4.1 flow cell (FLO-MIN106) according to the manufacturer's instructions. Basecalling was completed using Guppy version 5.0.11 with default settings using the Cloud Infrastructure for Big Data Microbial Bioinformatics (CLIMB) platform [55].

## Hybrid genome assembly and annotation

A hybrid assembled and annotated genome consisting of Illumina short reads and ONT long reads was produced using the Comprehensive Genome Analysis tool provided by the PATRIC 3.6.10 Bioinformatics Resource Center [56]. Unicycler [57] was selected as the assembly strategy and annotation was completed using the RAST toolkit (RASTtk) [58].

## In vivo *G. mellonella* infection to determine median lethal dose of *C. pauculus* MF1

Larvae of the greater wax moth *G. mellonella* were purchased from Livefood UK and stored in the dark at 4 °C for up to 7 days without food or water. Larvae were selected to be 21±1 mm in length and healthy, as determined by a uniform cream colour, with no indications of melanization. Larval length can be correlated to weight according to a linear regression, such that a length of 21±1 mm equates to a weight of 208.2±22.2 mg, which is within the optimum range (180–260 mg) for determination of median lethal dose (LD<sub>50</sub>) using this model [59]. To prepare the *C. pauculus* MF1 inoculum, the isolate was grown overnight in 10 ml LB broth (Fisher Scientific, UK) at 37 °C and collected by centrifugation at 2500 g for 10 min. The pellet was then resuspended in 10 ml PBS to wash the cells, before repeating the centrifugation once more and finally resuspending the pellet in 1 ml PBS. The resulting suspension was tenfold serially diluted and bacterial density was confirmed by viable count assay using the Miles and Misra method [60].

Ten larvae were injected per serial dilution of *C. pauculus* MF1 (10<sup>2</sup>, 10<sup>3</sup>, 10<sup>4</sup>, 10<sup>5</sup>, 10<sup>6</sup> and 10<sup>7</sup> c.f.u./10 µl) into the left penultimate pro-leg using a 50 µl Hamilton 750 syringe (Hamilton Company, NV, USA) with a removable 26S gauge needle. A placebo control of sterile PBS was used to account for the physical trauma of injection (*n*=10), along with a 'no manipulation' control to account for normal survival (*n*=10). Injected larvae were placed into sterile Petri dishes and incubated at 37 °C in the dark without food or water for 48 h. After 24 and 48 h, the percentage of live larvae in each treatment group was recorded. Larvae were recorded as dead when they met at least two of the following criteria: (i) obvious melanization, (ii) no response to touch, (iii) no correction when rolled on back [59]. For each time point, the LD<sub>50</sub> was calculated by plotting c.f.u./larva against percentage live larvae and interpolating the curve for 50%. The mean average of three biological replicates is reported.

## Biofilm formation compared to *P. aeruginosa* PAO1

The CV solubilization assay was used to measure the biomass of formed biofilm in microplates according to the methods published previously [61–63]. *P. aeruginosa* was selected as a comparator organism due to its wide acceptance as a versatile biofilm-forming organism [64–66], and PAO1 was selected due to its ubiquity in research as a well-characterized strain [67]. *C. pauculus* MF1 and *P. aeruginosa* PAO1 were each inoculated in tryptic soy broth (TSB; Sigma-Aldrich, MO, USA) and Reasoner's 2A (R2A) broth (prepared in-house identically to Oxoid CM0906 but omitting agar, see the Supplementary Material, available in the online version of this article, for composition) and incubated at 37 °C until log phase. Cultures were then adjusted to 1×10<sup>6</sup> c.f.u. ml<sup>-1</sup> and 200 µl/well added to flat-bottom 96-well plates (Thermo Scientific Biolite). There were 12 technical replicates per bacteria-media combination. Outer microplate wells were filled with 200 µl sterile water to exclude any edge effects and a negative control of broth alone was included. Plates were incubated statically at 37 °C or 20 °C for 24–72 h. To quantify biomass of biofilm formed, at each time point plates were washed with dH<sub>2</sub>O to remove nonadherent cells, stained by addition of 200 µl/well 0.1% (*w/v*) CV solution, and incubated at RT for 20 min. CV was removed by pipette and then wells were washed again with dH<sub>2</sub>O to remove unbound CV. Plates were dried at 60 °C for 30 min before cooling and solubilizing CV by addition of 200 µl/well 30% (*v/v*) acetic acid and incubating at RT on a shaking platform for 30 min. Absorbance was read at 575 nm using a SPECTROstar Omega (BMG Labtech, UK). The mean absorbance of negative controls was subtracted from that of each experimental well to account for background staining. At each time point, plates not being measured were also refreshed by removing liquid from wells and replacing with 200 µl/well appropriate fresh media.

## Statistical analysis

All experiments consist of three independent biological replicates and at least three technical replicates per group, or more where indicated. Statistical analyses were conducted using GraphPad Prism v9.1.1 for macOS (GraphPad Software).

Data were checked for normal distribution using the Shapiro–Wilk test. Two-way ANOVA was conducted on biofilm data, with Šídák's multiple comparisons test. All statistical analyses used a 95% confidence limit, so that *P*-values equal to or greater than 0.05 were not considered statistically significant.

## RESULTS

### Initial isolation and identification of the strain

The isolate appeared as grey round easily emulsifiable colonies on CBA, and Gram-negative bacilli were apparent on staining. Sanger sequencing of the 16S rRNA gene PCR product and subsequent processing yielded a 1392 base pair (bp) consensus sequence. A BLAST search gave resolution to genus-level, but species-level identification could not be completed due to many

100% identity and 100% query cover matches to multiple *Cupriavidus* species (*C. pauculus*: MW960228, MW049071, MW049067, AY860236, AB109753; *C. taiwanensis*: EU915716) and multiple sequences identified only to genus level as *Cupriavidus* (GU566329, EU827490, EU596431).

### Draft genome sequencing

Incorporation of both the Illumina short reads and ONT long reads in a hybrid assembly resulted in a 6.8 Mb draft genome of five contigs, with a 'good' quality determination by PATRIC and 0% contamination. The number of coding sequences (CDS) was 6468 – of which 4063 were given functional assignments. PATRIC indicated that the genome was 99.5% complete. For further details of the hybrid assembly and annotated genome, see Table S1. Summary statistics from the ONT MinION sequencing run can be found in Table S2 and characteristics of an assembly resulting from Illumina reads alone can be found in Table S3.

Multi-locus sequence typing (MLST) using the autoMLST web tool (<https://automlst.ziemertlab.com/>) gave the closest match as 98.2% average nucleotide identity (ANI) to *C. pauculus* KF709 (NBRC 110672) deposited as GCA\_000974605 [3]. As the ANI cut-off for new prokaryotic species is given as 95% [68, 69], the isolate was concluded to be part of the existing species *C. pauculus*. See Table S4 for the top 10 MLST results. To confirm the MLST classification, the Genome-to-Genome Distance Calculator provided by the Leibniz Institute DSMZ was used to run a digital DNA–DNA hybridization (DDH) to mimic DDH *in silico* [70]. This tool uses three independent formulae, reporting three DDH values. The results were 73.8, 85.4 and 78.5% (mean 79.2%) against the closest match, *C. pauculus* KF709 as above. A DDH value of  $\geq 70\%$  is recommended as the threshold for definition of members of the same species [71, 72], thus on this basis the isolate was confirmed to be part of the existing species *C. pauculus*. The strain was designated MF1.

The RASTtk within PATRIC was used to identify antibiotic resistance genes (ARGs), virulence factor genes (VFs) and metal resistance genes (MRGs). The full list of the genes of interest within these categories can be found in Table 1. In total, 12 ARGs, 8 VF genes and 33 MRGs were identified.

### Susceptibility to antibiotics

The MICs of antibiotics against the *C. pauculus* MF1 isolate and the resulting susceptibility classifications can be found in Table 2. As breakpoint tables for this genus are not available, susceptibility classifications were based on breakpoints for *Pseudomonas* spp. as has been published previously [28, 30, 54], as well as PK-PD breakpoint values, which are not species-specific. The isolate showed susceptibility or intermediate susceptibility to the cephalosporins cefotaxime, ceftazidime and cefepime. For carbapenems, resistance to meropenem was clear however the isolate was susceptible to imipenem with little additional benefit conferred by the inclusion of the  $\beta$ -lactamase inhibitor relebactam. The isolate was resistant to amoxicillin but could be sensitized to some degree by the addition of the  $\beta$ -lactamase inhibitors relebactam or clavulanate, which reduced the MIC by over 32-fold and 8-fold, respectively. Low MICs were observed for both ciprofloxacin (a fluoroquinolone) and doxycycline (a tetracycline) while high MICs were found for both gentamicin and amikacin (aminoglycosides). The MIC of erythromycin was above that which could be considered clinically beneficial, however conclusive classification is not possible due to the lack of a published breakpoint. Finally, the isolate can be classified as resistant to colistin.

### Median lethal dose in *G. mellonella* larvae

The 24 h LD<sub>50</sub> of *C. pauculus* MF1 in *G. mellonella* was determined to be  $2.54 \times 10^7$  c.f.u./larva ( $SD \pm 5.99 \times 10^6$ ) while the 48 h LD<sub>50</sub> was determined to be  $2.64 \times 10^6$  c.f.u./larva ( $SD \pm 1.82 \times 10^6$ ). Taking the calculated average weight of larvae used in this study as 208.2 mg, these LD<sub>50</sub> values equate to  $1.22 \times 10^5$  c.f.u. mg<sup>-1</sup> (24 h) and  $1.27 \times 10^4$  c.f.u. mg<sup>-1</sup> (48 h).

### Biofilm formation compared to *P. aeruginosa* PAO1

Both *C. pauculus* MF1 and *P. aeruginosa* PAO1 formed detectable biofilms in minimal (R2A) and rich (TSB) broth at both physiological (37 °C) and environmental (20 °C) temperatures between 24–72 h (Fig. 1). In R2A broth at 37 °C, *C. pauculus* biofilm built gradually and significantly overtook that of *P. aeruginosa* after 48 and 72 h (Fig. 1a). In R2A broth at 20 °C, *P. aeruginosa* formed much more biofilm, almost reaching maximum signal after only 24 h, while *C. pauculus* biofilm steadily built across the whole 72 h, though not overtaking that of *P. aeruginosa* under the same conditions (Fig. 1b). Generally, biofilm levels reached in TSB were greater than in R2A broth (Fig. 1c, d). In TSB at 37 °C, the *C. pauculus* biofilm climbed from a low level at 24 h and reached a similar high level as *P. aeruginosa* after 72 h (Fig. 1c). In TSB at 20 °C, *P. aeruginosa* biofilm levels reached similar high levels after 48 h onwards but at 24 h showed clearly less biofilm than at 37 °C (Fig. 1d). The *C. pauculus* biofilm built across 24–72 h in TSB at 20 °C but did not reach the same level as *P. aeruginosa* by the endpoint (Fig. 1d).

## DISCUSSION

*C. pauculus* is an emerging human pathogen, having previously been chiefly isolated from soil and aquatic environments. Here, we present its isolation from a hospital sink trap – a niche known to act as a reservoir of pathogens in clinical settings and

**Table 1.** Genes of interest found within the *C. pauculus* MF1 draft genome

Gene type	Gene name	Gene product/function
Antibiotic resistance genes	<i>AmpC</i>	$\beta$ -lactamase
	<i>adeF, adeG</i>	RND multidrug efflux pump (AdeFGH)
	<i>arnT</i>	Aminoarabinose transferase enzyme conferring colistin resistance
	<i>bla<sub>OXA</sub></i>	Class D $\beta$ -lactamase
	<i>ceoB</i>	Cytoplasmic membrane component of the CeoAB-OpcM efflux pump
	<i>EmrAB-TolC</i>	Multidrug efflux system
	<i>H-NS</i>	Regulates expression of multidrug exporter genes
	<i>MacA, MacB</i>	Form an antibiotic efflux complex with TolC active against macrolides
	<i>MdtABC-TolC</i>	Multidrug efflux system
	<i>MexAB-OprM</i>	Multidrug efflux system
Virulence factors	<i>argG</i>	Argininosuccinate synthase; arginine synthesis
	<i>aroC</i>	Chorismate synthase; aromatic amino acid synthesis
	<i>hfq</i>	RNA chaperone at the post-transcriptional level
	<i>leuB</i>	3-isopropylmalate dehydrogenase
	<i>ppsA</i>	Phosphoenolpyruvate synthase
	<i>recA</i>	DNA repair and maintenance
	<i>rpoE</i>	RNA polymerase sigma E; facilitates bacterial growth at high temperature and may facilitate persistence in macrophages
	<i>trpG</i>	Anthranilate synthase component
Metal resistance genes	<i>acr3</i>	Transmembrane arsenite transporter
	<i>arsH</i>	Methylarsenite oxidase; ferric reductase activity and protection from oxidative stress
	<i>cbtA</i>	Putative cobalt transporter subunit
	<i>cnrR, cnrY</i>	Nickel and cobalt resistance
	<i>cobS-T, cobN, cobW</i>	Cobalt chelatases involved in cobalamin synthesis, <i>cobW</i> is a putative zinc chaperone
	<i>copC-D, copZ</i>	Copper chaperone and sequestration, may also bind silver and cadmium
	<i>corA, corC</i>	Na <sup>+</sup> -dependent Mg <sup>2+</sup> transporter
	<i>cusA-C, cusR-S</i>	Copper and silver resistance
	<i>cutE</i>	Copper transport
	<i>czcA-D, czcI, czcN</i>	Cadmium, zinc, and cobalt efflux
	<i>merP, merR, merT</i>	Mercury resistance
	<i>modA-C</i>	Components of molybdate uptake operon
	<i>nikR</i>	Transcriptional regulator of the nikABCDE operon

Listed are genes of interest found in the *C. pauculus* MF1 isolate whole genome, as annotated and highlighted by the PATRIC Comprehensive Genome Analysis tool using both CARD and PATRIC databases.

contribute to nosocomial transmission [36–40]. This study reports the draft hybrid genome sequence of the isolate and investigates its antimicrobial susceptibility, virulence in an *in vivo* model, and biofilm formation in relevant conditions compared to a well-characterized biofilm-forming model organism.

The isolate could not be identified to species-level using 16S rRNA gene sequencing; WGS was therefore indicated for identification and to further investigate the organism. A hybrid assembly of ONT and Illumina reads allowed a more complete genome to be

**Table 2.** MICs of antibiotics against the *C. pauculus* MF1 isolate

Class	Antibiotic	MIC ( $\mu\text{g ml}^{-1}$ )	Classification ( <i>Pseudomonas</i> spp.)	Classification (PK-PD)
Cephalosporins	Cefotaxime	1	N/A	Susceptible
	Ceftazidime	8	Intermediate*	Intermediate
	Cefepime	0.25	Intermediate*	Susceptible
Carbapenems	Meropenem	>512	Resistant	Resistant
	Imipenem	0.5	Intermediate*	Susceptible
	Imipenem-Relebactam (2:1)	0.25	Susceptible	Susceptible
Penicillins	Amoxicillin	>512	N/A	Resistant
	Amoxicillin-Relebactam (16:1)	16	N/A	N/A
	Amoxicillin-Clavulanate (5:1)	64	N/A	Resistant
Aminoglycosides	Gentamicin	512	IE	Resistant
	Amikacin	512	Resistant	Resistant
Fluoroquinolones	Ciprofloxacin	0.125	Intermediate*	Susceptible
Macrolides	Erythromycin	32	N/A	IE
Tetracyclines	Doxycycline	0.25	N/A	IE
Polymyxins	Colistin	16	Resistant	IE

MICs of antibiotics against the *C. pauculus* MF1 isolate and the resulting susceptibility/resistance classifications. Classifications according to the breakpoints for *Pseudomonas* spp. are given as well as classifications based on pharmacokinetic-pharmacodynamic data provided by EUCAST. 'N/A' indicates that a breakpoint is not available. 'IE' indicates that EUCAST report there is insufficient evidence to consider a particular agent as a therapy and give no breakpoint. Intermediate with an asterisk (\*) indicates that an MIC breakpoint of  $\leq 0.001 \mu\text{g ml}^{-1}$  is given as an 'arbitrary off scale' breakpoint by EUCAST. Where any set of results contained differences of more than one serial dilution step, the assays were repeated. Shown are the consensus (mode) results of three biological replicates; alternatively, the midpoint was used if the three results were within one serial dilution step of each other.

achieved, adding to only six other genomes available for this species – two of which are PacBio/Illumina hybrids. Of these hybrids, both (GCA\_008693385 and GCA\_003854935) were submitted as part of the same FDA-ARGOS [73] project (PRJNA231221) in 2019 and consist of two contigs with one and two plasmids, respectively. The number of CDS identified in this study (6468) was greater than in both available hybrid genomes (6286 and 5483) although there was a difference in annotation method (RASTtk in PATRIC for this study vs NCBI Prokaryotic Genome Annotation Pipeline for the FDA-ARGOS project). There was also a difference in total sequence length (6.8 Mb versus 7.1 Mb and 6.2 Mb). Finally, the genome reported in this study did not contain any identifiable plasmids.

Through WGS, several ARGs were identified (Table 1) – mostly components of efflux pumps (*adeG*, *EmrAB-TolC*, *MdtABC-TolC*, *MexAB-OprM*, *MacA/MacB*) as well as other sequences identified by RASTtk as  $\beta$ -lactamases (*AmpC*, *bla<sub>OXA</sub>*). Phenotypic resistance to meropenem, amoxicillin, amikacin, gentamicin and colistin was evident. The  $\beta$ -lactamase inhibitors relebactam and clavulanate reduced the MIC of amoxicillin, suggesting a resistance mechanism involving a  $\beta$ -lactamase, however the resulting MICs were still not within a clinically relevant range. The isolate was clearly susceptible to cefotaxime, cefepime, imipenem and ciprofloxacin. The antibiotic susceptibility profile appeared to broadly match that for *C. pauculus* reported by Massip *et al.* [30], except in the cases of meropenem (>512  $\mu\text{g ml}^{-1}$  here versus 16–64  $\mu\text{g ml}^{-1}$  reported) and amikacin (512  $\mu\text{g ml}^{-1}$  here versus 8–128  $\mu\text{g ml}^{-1}$  reported). Through further analysis of the ARGs identified by RASTtk, it became apparent that certain genes, which only confer resistance following acquisition of point mutations, such as *gyrA* and *rpsJ* [74, 75], are automatically identified as genes of interest – even when they lack the required mutations. Following investigation, these genes were discounted from our reported genes of interest. This highlights the importance of manually checking the output of genome annotation pipelines to confirm the relevance of identified genes.

While none of the mobilized colistin resistance (*mcr*) genes were identified in the genome, the isolate's phenotypic resistance to colistin may be explained by the presence of an *arnT* homologue with 81% identity and 99% query cover against that reported in *C. metallidurans* CH34 (CP000353.2:1481129–1482725) [30]. Aminoarabinose transferase (ArnT) catalyses the attachment of the cationic sugar 4-amino-4-deoxy-L-arabinose to lipid A, resulting in charge modification of the bacterial outer membrane and polymyxin resistance [32]. Homologues of *arnT* have previously been described in *C. pauculus*, *C. basilensis*, *C. necator* and *C. taiwanensis* as the cause of colistin resistance [30].

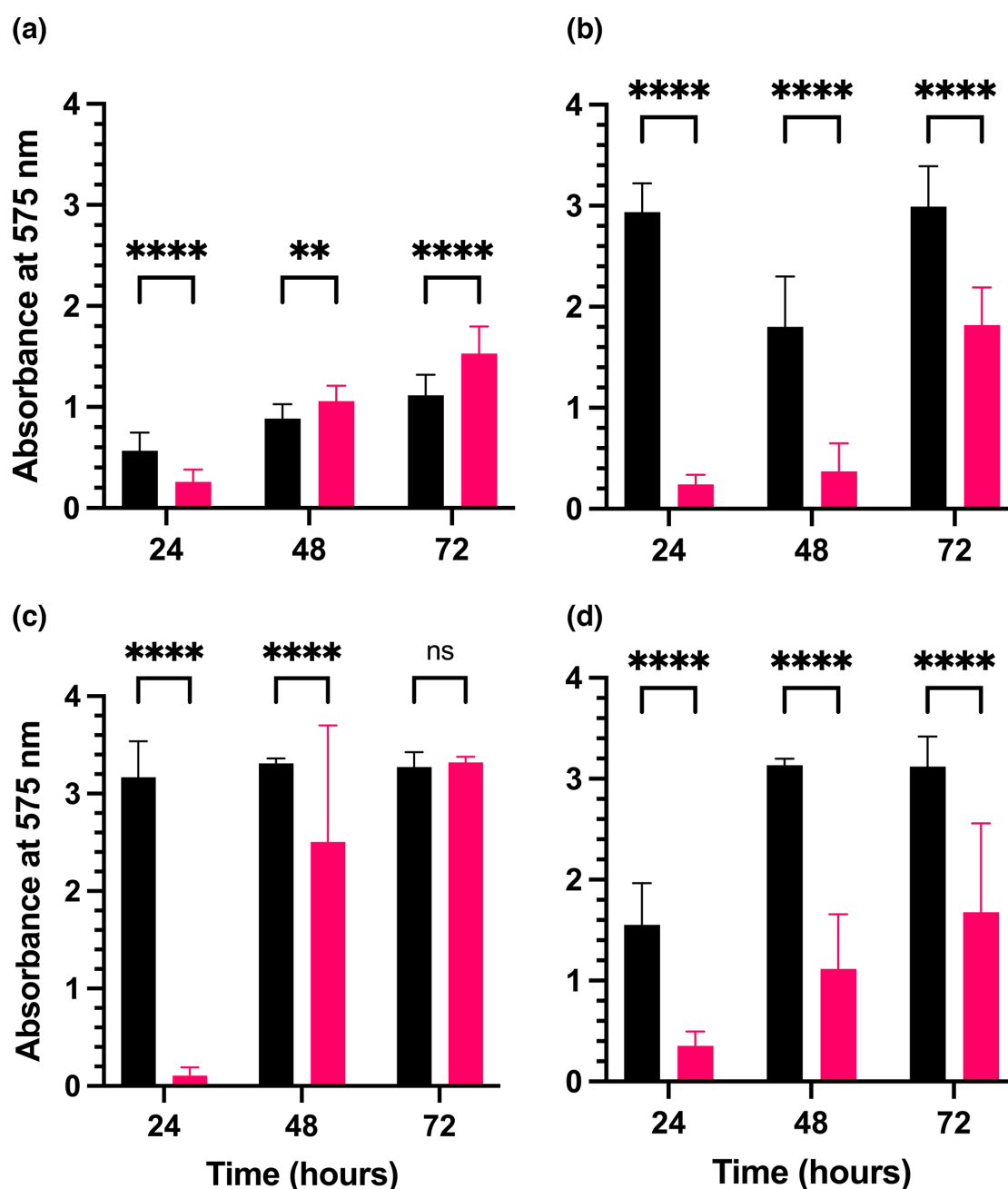

**Fig. 1.** Biofilm formation by *C. pauculus* MF1 (pink) and *P. aeruginosa* PA01 (black) in R2A broth at either 37 °C (a) or 20 °C (b) and in TSB at either 37 °C (c) or 20 °C (d) over 72 h as determined by the CV solubilization assay. Data presented as mean  $\pm$  SD. \*\*\*\*  $P < 0.0001$ , \*\*  $P < 0.01$ , ns: not significant; two-way ANOVA with Šidák's multiple comparisons test. Data presented are the average of  $n = 3$  biological replicates.

A large number ( $n = 33$ ) of MRGs were identified in the WGS. Together, the MRGs listed in Table 1 contribute to resistance to copper, silver, magnesium, cobalt, mercury, molybdenum, arsenic, zinc, cadmium, iron, antimony and nickel. Many species of *Cupriavidus* including *C. pauculus* [76, 77], *C. metallidurans* [78, 79], *C. gilardii* [80], *C. campinensis* [81] and *C. neocaledonicus* [82] are considered to be metal resistant. Many of these genes confer resistance to metals by means of intracellular metal sequestration to facilitate export, as in the case of *CopZ* with  $\text{Cu}^+$  ions [83],  $\text{Ag}^+$  and  $\text{Cd}^{2+}$  ions [84]. There is a link between metal and antibiotic resistance, in that ARGs can co-locate on mobile genetic elements carrying MRGs such as the integrative conjugative element ICEHs1, which contains 83 genes, including both ARGs (*tetH*, *ebrB*) and MRGs (*mco*, *czcD*, *acr3*) [85].

The RASTtk annotation also identified a number ( $n = 8$ ) of VF. One of these, *hfq*, is a known pleiotropic regulator of virulence genes with the protein Hfq acting as an RNA chaperone and modulating mRNA translation and stability [86]. Another, *recA*, is involved in

recombination, repair and maintenance of DNA, as well as induction of prophage [87]. *Salmonella typhimurium* mutants deficient of *recA* have been shown to be less virulent in BALB/c mice and more susceptible to macrophage killing by oxidative burst [88]. The alternative sigma factor *rpoE* is essential for some species such as *E. coli* [89], and is also induced by stressors, including heat and accumulation of misfolded proteins, to trigger extensive alterations in gene expression [90, 91]. RpoE, its product, has been shown to be important for intracellular survival of *Salmonella typhimurium* in macrophages [92]. The *G. mellonella* larvae model, a well-characterized model for virulence and lethality testing, was used to assess median lethal dose of the isolate. Non-lethal isolates (non-pathogenic *E. coli* DH5a) have previously been reported with an LD<sub>50</sub> of around 10<sup>7</sup> c.f.u./larva [93], which is around the same range as the 24 h LD<sub>50</sub> values reported in this study. As would be expected, the 48 h LD<sub>50</sub> values were lower than those at 24 h but remained relatively high. This suggests that *C. pauculus* MF1 exhibits low levels of virulence, at least in *G. mellonella* in the conditions described. There is some room for interpretation in all findings for *G. mellonella* as authors calculate and report results in myriad ways, e.g. c.f.u./larva versus c.f.u. mg<sup>-1</sup>, and some authors do not report whether they controlled for larval size or weight. Larval weight shows a strong correlation to larval liquid volume [94], and it follows that injections into larger larvae will lead to greater inoculum dilution possibly leading to error in the reported LD<sub>50</sub>. *G. mellonella* are particularly susceptible to killing by *P. aeruginosa*, with a reported LD<sub>50</sub> of only 10 c.f.u. [95]. Meanwhile the 24 h LD<sub>50</sub> values of uropathogenic *E. coli* isolates have been determined to be around 1.6×10<sup>4</sup> c.f.u./larva (ST69) and 1.2×10<sup>4</sup> c.f.u./larva (ST127) [93]. The 48 h LD<sub>50</sub> of two strains of *Burkholderia cepacia* have been reported as 30 c.f.u./larva or 1 c.f.u./larva while that of eight strains of *B. cenocepacia* ranged from 9×10<sup>2</sup> c.f.u./larva to 2×10<sup>5</sup> c.f.u./larva [96]. It is noteworthy that despite them both belonging to *Burkholderiaceae*, *C. pauculus* MF1 and the strains of *B. cepacia* and *B. cenocepacia* have significantly different LD<sub>50</sub> values in *G. mellonella*, which may be explained by differences in virulence factors and resulting pathogenicity. The virulence of *Burkholderia* spp. is the result of potent biofilm formation, intrinsic antibiotic resistance, metabolic and genetic plasticity, multiple secretion systems, and the ability to persist intracellularly within macrophages and other eukaryotic cells [97]. Further evaluation of the *in vivo* virulence of this and other *C. pauculus* strains in another model would provide a valuable insight.

Biofilm formation was determined in 96-well plates according to a widely used protocol involving staining and solubilization of CV, which binds to all microbial biomass within each well. The CV solubilization assay therefore quantifies biofilm biomass, but cannot enumerate bacterial cells or indicate their viability. R2A agar was initially developed for enumeration and subculture of bacteria from potable water [98], and so we propose that R2A broth can serve as an appropriate medium for measuring biofilm formation in conditions most relevant to the sink trap and WPS as has been completed previously [99, 100]. However, as mentioned in the Introduction, it is important to bear in mind that disposal of liquids and solids via sink traps will result in variable nutrient conditions and so there is no perfect laboratory model to mimic real-life sink traps or WPS. At both physiological and environmental temperatures in minimal and rich conditions, *C. pauculus* biofilm was evident from 24 h and increased consistently over the 72 h experiments. When studied at 37°C in R2A broth, the *C. pauculus* MF1 biofilm even overtook that of *P. aeruginosa* PAO1 – a classic model organism for biofilm formation. There has been little previous work published on *C. pauculus* biofilm formation and, to our knowledge, this is the first report using the CV solubilization assay. A study investigating the efficacy of different disinfectants against biofilms containing *C. pauculus* recovered from the International Space Station's water system found that an 18 h flush of either 6% H<sub>2</sub>O<sub>2</sub> solution or a mixture of 3% H<sub>2</sub>O<sub>2</sub> and 400 parts per billion colloidal silver effectively reduced the viability of 5 day preformed biofilms to <1 c.f.u. ml<sup>-1</sup> for up to 3 months. It is noteworthy that in the same study, the control biofilm became predominated with *C. pauculus* at an 8:2 ratio with *Burkholderia multivorans*, despite equal seeding of these and two other isolates [101]. The ability of *C. pauculus* to persist in oligotrophic conditions, whilst producing EPS, which may shield it from disinfectants and detergents, reinforces concerns that it may successfully persist in hospital WPS. The ability of *C. pauculus* MF1 to form a biofilm shown in this study, overtaking that of *P. aeruginosa* PAO1 at 37°C, is concerning and could suggest an ability to establish chronic, recalcitrant infections in humans like *P. aeruginosa* does, particularly in cystic fibrosis patients [65, 102]. It would be valuable to further investigate *C. pauculus* virulence under physiological conditions *in vivo*, perhaps with comparisons between clinical and environmental strains to determine whether potent biofilm formation is a feature of both, or is limited to environmental persistence.

This study cannot identify the source of the *C. pauculus* isolate recovered, thus it is impossible to determine whether the isolate described here originated from a human carrier, or was brought in via another route (e.g. the water supply). Nevertheless, it is concerning that an organism previously described as being of environmental origin, which has recently been implicated in several serious cases of human infection, has been isolated in a known pathogen reservoir in a clinical setting. It is further concerning that the isolate is multidrug resistant, including to the antibiotic of last-resort, colistin, to which it has previously been reported to be susceptible and which has been used therapeutically [17]. While there is clear evidence of *C. pauculus* causing morbidity and mortality, which makes its colonization of a sink trap a problem in its own right, it also poses a potential threat due to the carriage and possible horizontal transfer of ARGs. Further investigation and evidence is needed to be able to determine whether *C. pauculus* has more widely crossed into pathogen reservoirs such as sink traps, or whether the isolate described here was an incidental finding.

#### Funding information

This work received no specific grant from any funding agency. The authors acknowledge internal funding from the School of Engineering, Computing and Mathematics and the School of Biomedical Sciences at the University of Plymouth, which indirectly supported this work.



## Acknowledgements

The authors are grateful to Dr Jonathan Cox (Aston University) and Mr Matthew Emery (University of Plymouth) for the provision of reagents for antimicrobial susceptibility testing, and to Dr Jo Fothergill (University of Liverpool) for the provision of *P. aeruginosa* PAO1. The authors thank Matthew Koch (University of Plymouth) and Poppy Hesketh Best (University of Plymouth) for advice on conducting Oxford Nanopore MinION sequencing.

## Author contributions

Conceptualization: J.B., S.D.K. and M.U. Data curation: J.B. Formal analysis: J.B. Funding acquisition: M.U. and A.B. Investigation: J.B., S.D.K. and K.J.M. Methodology: J.B., S.D.K. and M.U. Project administration: M.U. Resources: J.B., S.D.K. and M.U. Supervision: M.U. Validation: J.B. and K.J.M. Visualization: J.B. Writing – original draft: J.B. Writing – review and editing: J.B., S.D.K., K.J.M., A.B. and M.U.

## Conflicts of interest

The authors declare that there are no conflicts of interest.

## References

- Feng T, Kim KH, Oh J, Jeon CO. *Cupriavidus lacunae* sp. nov., isolated from pond-side soil. *Antonie van Leeuwenhoek* 2019;112:543–551.
- Makkar NS, Casida LE. *Cupriavidus necator* gen. nov., sp. nov.; a nonobligate bacterial predator of bacteria in sNonobligate Bacterial Predator of Bacteria in Soil. *Int J Syst Bacteriol* 1987;37:323–326.
- Watanabe T, Yamazoe A, Hosoyama A, Fujihara H, Suenaga H, et al. Draft genome sequence of *Cupriavidus pauculus* strain KF709, a biphenyl-utilizing bacterium isolated from biphenyl-contaminated soil. *Genome Announc* 2015;3:e00222–15.
- Schmidt T, Schlegel HG. Nickel and cobalt resistance of various bacteria isolated from soil and highly polluted domestic and industrial wastes. *FEMS Microbiol Ecol* 1989;62:315–328.
- Wyndham RC, Nakatsu C, Peel M, Cashore A, Ng J, et al. Distribution of the catabolic transposon Tn5271 in a groundwater bioremediation system. *Appl Environ Microbiol* 1994;60:86–93.
- Aspinall ST, Graham R. Two sources of contamination of a hydrotherapy pool by environmental organisms. *J Hosp Infect* 1989;14:285–292.
- Manaia CM, Nunes OC, Morais PV, da Costa MS. Heterotrophic plate counts and the isolation of bacteria from mineral waters on selective and enrichment media. *J Appl Bacteriol* 1990;69:871–876.
- Oie S, Makieda D, Ishida S, Okano Y, Kamiya A. Microbial contamination of nebulization solution and its measures. *Biol Pharm Bull* 2006;29:503–507.
- Mora M, Perras A, Alekhova TA, Wink L, Krause R, et al. Resilient microorganisms in dust samples of the International Space Station-survival of the adaptation specialists. *Microbiome* 2016;4:65.
- Mijnendonckx K, Provoost A, Ott CM, Venkateswaran K, Mahillon J, et al. Characterization of the survival ability of *Cupriavidus metallidurans* and *Ralstonia pickettii* from space-related environments. *Microb Ecol* 2013;65:347–360.
- Moissenet D, Goujon CP, Garbarg-Chenon A, Vu-Thien H. CDC group IV c-2: a new *Ralstonia* species close to *Ralstonia eutropha*. *J Clin Microbiol* 1999;37:1777–1781.
- Vanechoutte M, Kämpfer P, De Baere T, Falsen E, Verschraegen G. *Wautersia* gen. nov., a novel genus accommodating the phylogenetic lineage including *Ralstonia eutropha* and related species, and proposal of *Ralstonia* [*Pseudomonas*] *syzygii* (Roberts et al. 1990) comb. nov. *Int J Syst Evol Microbiol* 2004;54:317–327.
- Vandamme P, Coenye T. Taxonomy of the genus *Cupriavidus*: a tale of lost and found. *Int J Syst Evol Microbiol* 2004;54:2285–2289.
- Langevin S, Vincelette J, Bekal S, Gaudreau C. First case of invasive human infection caused by *Cupriavidus metallidurans*. *J Clin Microbiol* 2011;49:744–745.
- Karafin M, Romagnoli M, Fink DL, Howard T, Rau R, et al. Fatal infection caused by *Cupriavidus gilardii* in a child with aplastic anemia. *J Clin Microbiol* 2010;48:1005–1007.
- Tena D, Losa C, Medina MJ, Sáez-Nieto JA. Muscular abscess caused by *Cupriavidus gilardii* in a renal transplant recipient. *Diagn Microbiol Infect Dis* 2014;79:108–110.
- Almasy E, Szederjesi J, Rad P, Georgescu A. A fatal case of community acquired *Cupriavidus Pauculus* pneumonia. *J Crit Care Med (Targu Mures)* 2016;2:201–204.
- Bianco G, Boattini M, Audisio E, Cavallo R, Costa C. Septic shock due to meropenem- and colistin-resistant *Cupriavidus pauculus*. *J Hosp Infect* 2018;99:364–365.
- Kweon OJ, Lim YK, Kim HR, Kim T-H, Ha S-M, et al. Isolation of a novel species in the genus *Cupriavidus* from a patient with sepsis using whole genome sequencing. *PLoS One* 2020;15:e0232850.
- Duggal S, Gur R, Nayar R, Rongpharpi SR, Jain D, et al. *Cupriavidus pauculus* (*Ralstonia paucula*) concomitant meningitis and septicemia in a neonate: first case report from India. *Indian J Med Microbiol* 2013;31:405–409.
- Kobayashi T, Nakamura I, Fujita H, Tsukimori A, Sato A, et al. First case report of infection due to *Cupriavidus gilardii* in a patient without immunodeficiency: a case report. *BMC Infect Dis* 2016;16:493.
- Yahya R, Alyousef W, Omara A, Alamoudi S, Alshami A, et al. First case of pneumonia caused by *Cupriavidus pauculus* in an infant in the Gulf Cooperation Council. *J Infect Dev Ctries* 2017;11:196–198.
- Shenai MB, Falconer R, Rogers S. A cupriavidus pauculus infection in a patient with a deep brain stimulation implant. *Cureus* 2019;11:e6104.
- Coenye T, Vandamme P, LiPuma JJ. Infection by *Ralstonia* species in cystic fibrosis patients: identification of *R. pickettii* and *R. mannitolilytica* by polymerase chain reaction. *Emerg Infect Dis* 2002;8:692–696.
- Kalka-MollWM, LiPuma JJ, Accurso FJ, Plum G, van Koningsbruggen S, et al. Airway infection with a novel *Cupriavidus* species in persons with cystic fibrosis. *J Clin Microbiol* 2009;47:3026–3028.
- Lipuma JJ. The changing microbial epidemiology in cystic fibrosis. *Clin Microbiol Rev* 2010;23:299–323.
- Stovall SH, Wisdom C, McKamie W, Ware W, Dedman H, et al. Nosocomial transmission of *Cupriavidus pauculus* during extracorporeal membrane oxygenation. *ASAIO J* 2010;56:486–487.
- D'Inzeo T, Santangelo R, Fiori B, De Angelis G, Conte V, et al. Catheter-related bacteremia by *Cupriavidus metallidurans*. *Diagn Microbiol Infect Dis* 2015;81:9–12.
- Huda SA, Yadava S, Kahlown S, Jilani MH, Sharma B. A rare case of ventilator-associated pneumonia caused by *Cupriavidus pauculus*. *Cureus* 2020;12:e8573.
- Massip C, Coullaud-Gamel M, Gaudru C, Amoureux L, Doleans-Jordheim A, et al. In vitro activity of 20 antibiotics against *Cupriavidus* clinical strains. *J Antimicrob Chemother* 2020;75:1654–1658.
- Vanechoutte M, Kämpfer P, De Baere T, Falsen E, Verschraegen G. *Wautersia* gen. nov., a novel genus accommodating the phylogenetic lineage including *Ralstonia eutropha* and related species, and proposal of *Ralstonia* [*Pseudomonas*] *syzygii* (Roberts et al. 1990) comb. nov. *Int J Syst Evol Microbiol* 2004;54:317–327.
- Petrou VI, Herrera CM, Schultz KM, Clarke OB, Vendome J, et al. Structures of aminoarabinose transferase ArnT suggest a molecular basis for lipid A glycosylation. *Science* 2016;351:608–612.
- Zhang H, Zong Z, Lei S, Srinivas S, Sun J, et al. A genomic, evolutionary, and mechanistic study of MCR-5 action suggests

- functional unification across the MCR family of colistin resistance. *Adv Sci (Weinh)* 2019;6:1900034.
34. Rashid M. A decade of adult intensive care unit design: a study of the physical design features of the best-practice examples. *Crit Care Nurs Q* 2006;29:282–311.
  35. Hopman J, Tostmann A, Wertheim H, Bos M, Kolwijck E, et al. Reduced rate of intensive care unit acquired gram-negative bacilli after removal of sinks and introduction of “water-free” patient care. *Antimicrob Resist Infect Control* 2017;6:59.
  36. Lowe C, Willey B, O’Shaughnessy A, Lee W, Lum M, et al. Outbreak of extended-spectrum  $\beta$ -lactamase-producing *Klebsiella oxytoca* infections associated with contaminated handwashing sinks(1). *Emerg Infect Dis* 2012;18:1242–1247.
  37. Regev-Yochay G, Smollan G, Tal I, Pinas Zade N, Haviv Y, et al. Sink traps as the source of transmission of OXA-48-producing *Serratia marcescens* in an intensive care unit. *Infect Control Hosp Epidemiol* 2018;39:1307–1315.
  38. Volling C, Ahangari N, Bartoszko JJ, Coleman BL, Garcia-Jeldes F, et al. Are sink drainage systems a reservoir for hospital-acquired gammaproteobacteria colonization and infection? a systematic review. *Open Forum Infect Dis* 2021;8:faa590.
  39. Franco LC, Tanner W, Ganim C, Davy T, Edwards J, et al. A microbiological survey of handwashing sinks in the hospital built environment reveals differences in patient room and healthcare personnel sinks. *Sci Rep* 2020;10:8234.
  40. De Geyter D, Vanstokstraeten R, Crombé F, Tommassen J, Wybo I, et al. Sink drains as reservoirs of VIM-2 metallo- $\beta$ -lactamase-producing *Pseudomonas aeruginosa* in a Belgian intensive care unit: relation to patients investigated by whole-genome sequencing. *J Hosp Infect* 2021;115:75–82.
  41. Ledwoch K, Robertson A, Lauran J, Norville P, Maillard JY. It’s a trap! The development of a versatile drain biofilm model and its susceptibility to disinfection. *J Hosp Infect* 2020;106:757–764.
  42. Hota S, Hirji Z, Stockton K, Lemieux C, Dedier H, et al. Outbreak of multidrug-resistant *Pseudomonas aeruginosa* colonization and infection secondary to imperfect intensive care unit room design. *Infect Control Hosp Epidemiol* 2009;30:25–33.
  43. Kotay S, Chai W, Guilford W, Barry K, Mathers AJ. Spread from the Sink to the Patient: *In Situ* Study Using Green Fluorescent Protein (GFP)-expressing *Escherichia coli* to model bacterial dispersion from hand-washing sink-trap reservoirs. *Appl Environ Microbiol* 2017;83:e03327–03316.
  44. Hajar Z, Mana TSC, Cadnum JL, Donskey CJ. Dispersal of gram-negative bacilli from contaminated sink drains to cover gowns and hands during hand washing. *Infect Control Hosp Epidemiol* 2019;40:460–462.
  45. Yui S, Muzslay M, Karia K, Shuttleworth B, Ali S, et al. Evaluation of droplet production by a new design of clinical handwash basin for the healthcare environment. *J Hosp Infect* 2019;103:e110–e114.
  46. Gormley M, Aspray TJ, Kelly DA, Rodriguez-Gil C. Pathogen cross-transmission via building sanitary plumbing systems in a full scale pilot test-rig. *PLoS One* 2017;12:e0171556.
  47. Grabowski M, Lobo JM, Gunnell B, Enfield K, Carpenter R, et al. Characterizations of handwashing sink activities in a single hospital medical intensive care unit. *J Hosp Infect* 2018;100:e115–e122.
  48. Kraupner N, Hutinel M, Schumacher K, Gray DA, Genheden M, et al. Evidence for selection of multi-resistant *E. coli* by hospital effluent. *Environ Int* 2021;150:106436.
  49. Muzslay M, Moore G, Alhussaini N, Wilson APR. ESBL-producing Gram-negative organisms in the healthcare environment as a source of genetic material for resistance in human infections. *J Hosp Infect* 2017;95:59–64.
  50. Inkster T, Peters C, Wafer T, Holloway D, Makin T. Investigation and control of an outbreak due to a contaminated hospital water system, identified following a rare case of *Cupriavidus pauculus* bacteraemia. *J Hosp Infect* 2021;111:53–64.
  51. Balada-Llasat J-M, Elkins C, Swyers L, Bannerman T, Pancholi P. Pseudo-outbreak of *Cupriavidus pauculus* infection at an outpatient clinic related to rinsing culturette swabs in tap water. *J Clin Microbiol* 2010;48:2645–2647.
  52. Lopeman RC, Harrison J, Rathbone DL, Desai M, Lambert PA, et al. Effect of amoxicillin in combination with imipenem-relebactam against *Mycobacterium abscessus*. *Sci Rep* 2020;10:928.
  53. EUCAST. *Breakpoint tables for interpretation of MICs and zone diameters*. 2021.
  54. Langevin S, Vincelette J, Bekal S, Gaudreau C. First case of invasive human infection caused by *Cupriavidus metallidurans*. *J Clin Microbiol* 2011;49:744–745.
  55. Connor TR, Loman NJ, Thompson S, Smith A, Southgate J, et al. CLIMB (the Cloud Infrastructure for Microbial Bioinformatics): an online resource for the medical microbiology community. *Microb Genom* 2016;2:e000086.
  56. Davis JJ, Wattam AR, Aziz RK, Brettin T, Butler R, et al. The PATRIC Bioinformatics Resource Center: expanding data and analysis capabilities. *Nucleic Acids Res* 2020;48:D606–D612.
  57. Wick RR, Judd LM, Gorrie CL, Holt KE. Unicycler: Resolving bacterial genome assemblies from short and long sequencing reads. *PLoS Comput Biol* 2017;13:e1005595.
  58. Brettin T, Davis JJ, Disz T, Edwards RA, Gerdes S, et al. RASTtk: a modular and extensible implementation of the RAST algorithm for building custom annotation pipelines and annotating batches of genomes. *Sci Rep* 2015;5:8365.
  59. Hesketh-Best PJ, Mouritzen MV, Shandley-Edwards K, Billington RA, Upton M. *Galleria mellonella* larvae exhibit a weight-dependent lethal median dose when infected with methicillin-resistant *Staphylococcus aureus*. *Pathog Dis* 2021;79:ftab003.
  60. Miles AA, Misra SS, Irwin JO. The estimation of the bactericidal power of the blood. *J Hyg (Lond)* 1938;38:732–749.
  61. Wand ME, Bock LJ, Turton JF, Nugent PG, Sutton JM. *Acinetobacter baumannii* virulence is enhanced in *Galleria mellonella* following biofilm adaptation. *J Med Microbiol* 2012;61:470–477.
  62. O’Toole GA. Microtiter dish biofilm formation assay. *J Vis Exp* 2011;2011:47.
  63. Shukla SK, Rao TS. An improved crystal violet assay for biofilm-quantification in 96-well microtitre plate. *bioRxiv*; 100214 2017. . DOI: 10.1101/100214DOI: 10.1101/100214 [Preprint]
  64. Moradali MF, Ghods S, Rehm BHA. *Pseudomonas aeruginosa* Lifestyle: A Paradigm for Adaptation, Survival, and Persistence. *Front Cell Infect Microbiol* 2017;7:39.
  65. Høiby N, Ciofu O, Bjarnsholt T. *Pseudomonas aeruginosa* biofilms in cystic fibrosis. *Future Microbiol* 2010;5:1663–1674.
  66. Ciofu O, Tolker-Nielsen T. Tolerance and resistance of *Pseudomonas aeruginosa* biofilms to antimicrobial agents-how *P. aeruginosa* can escape antibiotics. *Front Microbiol* 2019;10:913.
  67. Klockgether J, Munder A, Neugebauer J, Davenport CF, Stanke F, et al. Genome diversity of *Pseudomonas aeruginosa* PAO1 laboratory strains. *J Bacteriol* 2010;192:1113–1121.
  68. Goris J, Konstantinidis KT, Klappenbach JA, Coenye T, Vandamme P, et al. DNA-DNA hybridization values and their relationship to whole-genome sequence similarities. *Int J Syst Evol Microbiol* 2007;57:81–91.
  69. Richter M, Rosselló-Móra R. Shifting the genomic gold standard for the prokaryotic species definition. *Proc Natl Acad Sci U S A* 2009;106:19126–19131.
  70. Meier-Kolthoff JP, Auch AF, Klenk H-P, Göker M. Genome sequence-based species delimitation with confidence intervals and improved distance functions. *BMC Bioinformatics* 2013;14:60.
  71. Brenner DJ. Deoxyribonucleic acid reassociation in the taxonomy of enteric bacteria. *Int J Syst Bacteriol* 1973;23:298–307.
  72. Johnson JL. Use of nucleic-acid homologies in the taxonomy of anaerobic bacteria. *Int J Syst Bacteriol* 1973;23:308–315.
  73. Sichtig H, Minogue T, Yan Y, Stefan C, Hall A, et al. FDA-ARGOS is a database with public quality-controlled reference genomes for diagnostic use and regulatory science. *Nat Commun* 2019;10:3313.

74. Drlica K, Zhao X. DNA gyrase, topoisomerase IV, and the 4-quinolones. *Microbiol Mol Biol Rev* 1997;61:377–392.
75. Kubanov A, Vorobyev D, Chestkov A, Leinsoo A, Shaskolskiy B, et al. Molecular epidemiology of drug-resistant *Neisseria gonorrhoeae* in Russia (Current Status, 2015). *BMC Infect Dis* 2016;16:389.
76. Ramirez M, Obrzydowski J, Ayers M, Virparia S, Wang M, et al. Pyruvic oxime nitrification and copper and nickel resistance by a *Cupriavidus pauculus*, an active heterotrophic nitrifier-denitrifier. *ScientificWorldJournal* 2014;2014:901702.
77. Putonti C, Polley N, Castignetti D. Draft genome sequence of an active heterotrophic nitrifier-denitrifier, *Cupriavidus pauculus* UM1. *Genome Announc* 2018;6:e00028–18.
78. von Rozycki T, Nies DH. *Cupriavidus metallidurans*: evolution of a metal-resistant bacterium. *Antonie van Leeuwenhoek* 2009;96:115–139.
79. Mazhar SH, Herzberg M, Ben Fekih I, Zhang C, Bello SK, et al. Comparative insights into the complete genome sequence of highly metal resistant *Cupriavidus metallidurans* strain BS1 isolated from a gold-copper mine. *Front Microbiol* 2020;11:47.
80. Huang N, Mao J, Hu M, Wang X, Huo M. Responses to copper stress in the metal-resistant bacterium *Cupriavidus gilardii* CR3: a whole-transcriptome analysis. *J Basic Microbiol* 2019;59:446–457.
81. Abbaszade G, Szabó A, Vajna B, Farkas R, Szabó C, et al. Whole genome sequence analysis of *Cupriavidus campinensis* S14E4C, a heavy metal resistant bacterium. *Mol Biol Rep* 2020;47:3973–3985.
82. Klonowska A, Moulin L, Ardley JK, Braun F, Gollagher MM, et al. Novel heavy metal resistance gene clusters are present in the genome of *Cupriavidus neocaledonicus* STM 6070, a new species of *Mimosa pudica* microsymbiont isolated from heavy-metal-rich mining site soil. *BMC Genomics* 2020;21:214.
83. Radford DS, Kihlken MA, Borrelly GPM, Harwood CR, Le Brun NE, et al. CopZ from *Bacillus subtilis* interacts *in vivo* with a copper exporting CPx-type ATPase CopA. *FEMS Microbiol Lett* 2003;220:105–112.
84. Kihlken MA, Singleton C, Le Brun NE. Distinct characteristics of Ag<sup>+</sup> and Cd<sup>2+</sup> binding to CopZ from *Bacillus subtilis*. *J Biol Inorg Chem* 2008;13:1011–1023.
85. Bhatt K, Timsit E, Rawlyk N, Potter A, Liljebjelke K. Integrative conjugative element ICEHs1 encodes for antimicrobial resistance and metal tolerance in *Histophilus somni*. *Front Vet Sci* 2018;5:153.
86. Cech GM, Szalewska-Pałasz A, Kubiak K, Malabirade A, Grange W, et al. The *Escherichia coli* Hfq protein: an unattended DNA-transactions regulator. *Front Mol Biosci* 2016;3:36.
87. Horii T, Ogawa T, Ogawa H. Organization of the recA gene of *Escherichia coli*. *Proc Natl Acad Sci U S A* 1980;77:313–317.
88. Buchmeier NA, Lipps CJ, So MY, Heffron F. Recombination-deficient mutants of *Salmonella typhimurium* are avirulent and sensitive to the oxidative burst of macrophages. *Mol Microbiol* 1993;7:933–936.
89. De Las Peñas A, Connolly L, Gross CA. SigmaE is an essential sigma factor in *Escherichia coli*. *J Bacteriol* 1997;179:6862–6864.
90. Flores-Kim J, Darwin AJ. Regulation of bacterial virulence gene expression by cell envelope stress responses. *Virulence* 2014;5:835–851.
91. Roncarati D, Scarlato V. Regulation of heat-shock genes in bacteria: from signal sensing to gene expression output. *FEMS Microbiol Rev* 2017;41:549–574.
92. Humphreys S, Stevenson A, Bacon A, Weinhardt AB, Roberts M. The alternative sigma factor, sigmaE, is critically important for the virulence of *Salmonella typhimurium*. *Infect Immun* 1999;67:1560–1568.
93. Alghoribi MF, Gibreel TM, Dodgson AR, Beatson SA, Upton M. *Galleria mellonella* infection model demonstrates high lethality of ST69 and ST127 uropathogenic *E. coli*. *PLoS One* 2014;9:e101547.
94. Andrea A, Krogfelt KA, Jenssen H. Methods and challenges of using the greater wax moth (*Galleria mellonella*) as a model organism in antimicrobial compound discovery. *Microorganisms* 2019;7:E85.
95. Jarrell KF, Kropinski AM. The virulence of protease and cell surface mutants of *Pseudomonas aeruginosa* for the larvae of *Galleria mellonella*. *J Invertebr Pathol* 1982;39:395–400.
96. Seed KD, Dennis JJ. Development of *Galleria mellonella* as an alternative infection model for the *Burkholderia cepacia* complex. *Infect Immun* 2008;76:1267–1275.
97. Loutet SA, Valvano MA. A decade of *Burkholderia cenocepacia* virulence determinant research. *Infect Immun* 2010;78:4088–4100.
98. Reasoner DJ, Geldreich EE. A new medium for the enumeration and subculture of bacteria from potable water. *Appl Environ Microbiol* 1985;49:1–7.
99. Kotay SM, Parikh HI, Barry K, Gweon HS, Guilford W, et al. Nutrients influence the dynamics of *Klebsiella pneumoniae* carbapenemase producing enterobacteriales in transplanted hospital sinks. *Water Res* 2020;176:115707.
100. Garratt I, Aranega-Bou P, Sutton JM, Moore G, Wand ME, et al. Long-term exposure to octenidine in a simulated sink trap environment results in selection of *Pseudomonas aeruginosa*, *Citrobacter*, and *Enterobacter* isolates with mutations in efflux pump regulators. *Appl Environ Microbiol* 2021;87:e00210–00221.
101. Wong WC, Dudinsky LA, Garcia VM, Ott CM, Castro VA. Efficacy of various chemical disinfectants on biofilms formed in spacecraft potable water system components. *Biofouling* 2010;26:583–586.
102. Bhagirath AY, Li Y, Somayajula D, Dadashi M, Badr S, et al. Cystic fibrosis lung environment and *Pseudomonas aeruginosa* infection. *BMC Pulm Med* 2016;16:174.

### Five reasons to publish your next article with a Microbiology Society journal

1. The Microbiology Society is a not-for-profit organization.
2. We offer fast and rigorous peer review – average time to first decision is 4–6 weeks.
3. Our journals have a global readership with subscriptions held in research institutions around the world.
4. 80% of our authors rate our submission process as 'excellent' or 'very good'.
5. Your article will be published on an interactive journal platform with advanced metrics.

Find out more and submit your article at [microbiologyresearch.org](https://microbiologyresearch.org).

## Appendix A

# Investigation of hospital sink traps

### A.1 Media preparation

The components for R2A broth, prepared in-house identically to Oxoid CM0906, except omitting agar, are shown in Table A.1.

*Table A.1:* Components of Reasoner's 2A (R2A) broth

<b>Component</b>	<b>Concentration</b>
Yeast extract	0.5 g L <sup>-1</sup>
Proteose peptone	0.5 g L <sup>-1</sup>
Casein hydrolysate	0.5 g L <sup>-1</sup>
Glucose	0.5 g L <sup>-1</sup>
Starch	0.5 g L <sup>-1</sup>
Di-potassium phosphate	0.3 g L <sup>-1</sup>
Magnesium sulphate	0.024 g L <sup>-1</sup>
Sodium pyruvate	0.3 g L <sup>-1</sup>

## A.2 16S rDNA amplicon sequencing

### A.2.1 Quality control of MinION 16S rDNA amplicon sequencing of swabs from a hospital sink trap collected in 2017

Quality control statistics relating to the MinION 16S rDNA amplicon sequencing performed on swabs from the archived hospital sink trap are shown in Table A.2.

*Table A.2:* Quality control statistics from MinION 16S rDNA amplicon sequencing of hospital sink trap swabs

	<b>Sink trap</b>
<b>DNA added to sequencing library (ng)</b>	54.4
<b>Total reads after demultiplexing and adaptor trimming</b>	1,392,183
<b>Total reads after quality filtering</b>	260,523
<b>Total sequences classified by Kraken2</b>	260,415

An extended list of the genera identified by MinION 16S rDNA amplicon sequencing is shown in Table A.3.

## A.2. 16S RDNA AMPLICON SEQUENCING

---

Table A.3: Results of MinION-based 16S rDNA sequencing of an archived hospital sink trap

<b>Genus</b>	<b>Number of reads</b>
<i>Pseudomonas</i>	27 605
<i>Escherichia</i>	22 467
<i>Sphingomonas</i>	13 667
<i>Salmonella</i>	12 813
<i>Burkholderia</i>	8232
<i>Stenotrophomonas</i>	8083
<i>Novosphingobium</i>	8069
<i>Pseudoxanthomonas</i>	6670
<i>Klebsiella</i>	6117
<i>Sphingobium</i>	5196
<i>Edwardsiella</i>	3979
<i>Cupriavidus</i>	3370
<i>Bosea</i>	3140
<i>Thiomonas</i>	2829
<i>Enterobacter</i>	2761
<i>Yersinia</i>	2639
<i>Paraburkholderia</i>	2239
<i>Bacillus</i>	2212
<i>Serratia</i>	2140
<i>Azospira</i>	2000
<i>Dyella</i>	1632
<i>Bacteroides</i>	1614
<i>Methylobacterium</i>	1580
<i>Magnetospirillum</i>	1565
<i>Rhodanobacter</i>	1420
<i>Xylella</i>	1322
<i>Citrobacter</i>	1305
<i>Comamonas</i>	1176
<i>Erythrobacter</i>	1154
<i>Dokdonella</i>	1130
<i>Luteibacter</i>	1096
<i>Sphingopyxis</i>	1085
<i>Pelosinus</i>	999
<i>Bartonella</i>	875
<i>Liberibacter</i>	752
<i>Microbacterium</i>	730
<i>Vibrio</i>	690

**A.2.2 Quality control of Illumina 16S rDNA amplicon sequencing of hospital sink trap swabs collected in 2021**

Table A.4: Quality control statistics from Illumina 16S rDNA amplicon sequencing of hospital sink trap swabs

	<b>Pooled</b>	<b>Enriched</b>
<b>Raw paired end reads</b>	125,980	130,724
<b>Raw tags</b>	122,566	127,459
<b>Clean tags</b>	121,058	125,952
<b>Effective tags</b>	87,185	95,136
<b>Total bases (nt)</b>	36,953,044	40,437,932
<b>Average length (nt)</b>	424	425
<b>Q20</b>	98.79	98.87
<b>Q30</b>	95.79	96.01
<b>GC%</b>	54.97	54.69

## Appendix B

# Nanocoating development and characterisation

### B.1 Pipe cement composition

Table B.1 below indicates the chemical composition of the PVC pipe cement used to produce silver nanocoatings in this work.

*Table B.1:* Chemical composition of pipe cement used to produce the silver nanocoating. This information was taken from the Aquaflo PVC Cement safety data sheet.

<b>Component</b>	<b>Concentration</b>
Acetone	20–50 %
Ethyl methyl ketone	20–50 %
Ethyl acetate	10–15 %



*B.1. PIPE CEMENT COMPOSITION*

---

## **Appendix C**

# **Antibiofilm efficacy of the silver nanocoating against a hospital sink trap community in a model system and *in situ* in real-world sink traps**

### **C.1 Faculty Research Ethics and Integrity Committee approval**

Approval for an *in situ* experiment at University Hospitals Plymouth NHS Trust was sought from the University of Plymouth Faculty of Science and Engineering Research Ethics and Integrity Committee. The committee reported that approval was not required due to the lack of human participants in the study (see next page).



02 February 2021

**CONFIDENTIAL**

James Butler  
Faculty of Science and Engineering

Dear James

Thank you for submitting your research protocol and details concerning your research:

***in situ testing of antimicrobial nanocoatings in Derriford Hospital sink traps***

The Committee has reviewed the protocol and there are no concerns with the methodology or science.

As human participants are not involved in this research ethical approval from the Faculty of Science and Engineering Ethics, Research and Integrity Committee is not required.

If you have any queries please let me know.

Kind regards

*Olivia Wilson*

Olivia Wilson  
Chair of the Faculty Research Ethics & Integrity Committee

## **C.2 Integrated Research Application System (IRAS) application form**

A full application was submitted to the NHS Health Research Authority for approval to conduct *in situ* studies, via submission of an IRAS application form (see next pages).

## Welcome to the Integrated Research Application System

## IRAS Project Filter

The integrated dataset required for your project will be created from the answers you give to the following questions. The system will generate only those questions and sections which (a) apply to your study type and (b) are required by the bodies reviewing your study. Please ensure you answer all the questions before proceeding with your applications.

Please complete the questions in order. If you change the response to a question, please select 'Save' and review all the questions as your change may have affected subsequent questions.

**Please enter a short title for this project** (maximum 70 characters)

In situ testing of antimicrobial nanocoatings v1

**1. Is your project research?**

Yes  No

**2. Select one category from the list below:**

- Clinical trial of an investigational medicinal product
- Clinical investigation or other study of a medical device
- Combined trial of an investigational medicinal product and an investigational medical device
- Other clinical trial to study a novel intervention or randomised clinical trial to compare interventions in clinical practice
- Basic science study involving procedures with human participants
- Study administering questionnaires/interviews for quantitative analysis, or using mixed quantitative/qualitative methodology
- Study involving qualitative methods only
- Study limited to working with human tissue samples (or other human biological samples) and data (specific project only)
- Study limited to working with data (specific project only)
- Research tissue bank
- Research database

**If your work does not fit any of these categories, select the option below:**

Other study

**2a. Will the study involve the use of any medical device without a UKCA/CE UKNI/CE Mark, or a UKCA/CE UKNI/CE marked device which has been modified or will be used outside its intended purposes?**

Yes  No

**2b. Please answer the following question(s):**

- a) Does the study involve the use of any ionising radiation?  Yes  No
- b) Will you be taking new human tissue samples (or other human biological samples)?  Yes  No
- c) Will you be using existing human tissue samples (or other human biological samples)?  Yes  No

**3. In which countries of the UK will the research sites be located?** *(Tick all that apply)*

- England  
 Scotland  
 Wales  
 Northern Ireland

**3a. In which country of the UK will the lead NHS R&D office be located:**

- England  
 Scotland  
 Wales  
 Northern Ireland  
 This study does not involve the NHS

**4. Which applications do you require?**

- IRAS Form  
 Confidentiality Advisory Group (CAG)  
 Her Majesty's Prison and Probation Service (HMPPS)

**Most research projects require review by a REC within the UK Health Departments' Research Ethics Service. Is your study exempt from REC review?**

- Yes  No

**4b. Please confirm the reason(s) why the project does not require review by a REC within the UK Health Departments Research Ethics Service:**

- Projects limited to the use of samples/data samples provided by a Research Tissue Bank (RTB) with generic ethical approval from a REC, in accordance with the conditions of approval.
- Projects limited to the use of data provided by a Research Database with generic ethical approval from a REC, in accordance with the conditions of approval.
- Research limited to use of previously collected, non-identifiable information
- Research limited to use of previously collected, non-identifiable tissue samples within terms of donor consent
- Research limited to use of acellular material
- Research limited to use of the premises or facilities of care organisations (no involvement of patients/service users as participants)
- Research limited to involvement of staff as participants (no involvement of patients/service users as participants)

**5. Will any research sites in this study be NHS organisations?**

- Yes  No

**5a. Are all the research costs and infrastructure costs (funding for the support and facilities needed to carry out the research e.g. NHS support costs) for this study provided by a NIHR Biomedical Research Centre (BRC), NIHR Applied Research Collaboration (ARC), NIHR Patient Safety Translational Research Centre (PSTRC), or an NIHR Medtech and In Vitro Diagnostic Co-operative (MIC) in all study sites?**

Please see information button for further details.

Yes  No

Please see information button for further details.

**5b. Do you wish to make an application for the study to be considered for NIHR Clinical Research Network (CRN) Support and inclusion in the NIHR Clinical Research Network Portfolio?**

Please see information button for further details.

Yes  No

*The NIHR Clinical Research Network (CRN) provides researchers with the practical support they need to make clinical studies happen in the NHS in England e.g. by providing access to the people and facilities needed to carry out research "on the ground".*

*If you select yes to this question, information from your IRAS submission will automatically be shared with the NIHR CRN. **Submission of a Portfolio Application Form (PAF) is no longer required.***

**6. Do you plan to include any participants who are children?**

Yes  No

**7. Do you plan at any stage of the project to undertake intrusive research involving adults lacking capacity to consent for themselves?**

Yes  No

*Answer Yes if you plan to recruit living participants aged 16 or over who lack capacity, or to retain them in the study following loss of capacity. Intrusive research means any research with the living requiring consent in law. This includes use of identifiable tissue samples or personal information, except where application is being made to the Confidentiality Advisory Group to set aside the common law duty of confidentiality in England and Wales. Please consult the guidance notes for further information on the legal frameworks for research involving adults lacking capacity in the UK.*

**8. Do you plan to include any participants who are prisoners or young offenders in the custody of HM Prison Service or who are offenders supervised by the probation service in England or Wales?**

Yes  No

**9. Is the study or any part of it being undertaken as an educational project?**

Yes  No

Please describe briefly the involvement of the student(s):

PhD student (James Butler) is the Chief Investigator, and is taking the lead in planning the project, submitting this formal proposal, and will be conducting the experiments and analysis

**9a. Is the project being undertaken in part fulfilment of a PhD or other doctorate?**

Yes  No

**10. Will this research be financially supported by the United States Department of Health and Human Services or any of its divisions, agencies or programs?**

Yes  No

**11. Will identifiable patient data be accessed outside the care team without prior consent at any stage of the project (including identification of potential participants)?**

Yes  No



## Integrated Research Application System Application Form for Other research

### IRAS Form (project information)

Please refer to the E-Submission and Checklist tabs for instructions on submitting this application.

The Chief Investigator should complete this form. Guidance on the questions is available wherever you see this symbol displayed. We recommend reading the guidance first. The complete guidance and a glossary are available by selecting [Help](#).

Please define any terms or acronyms that might not be familiar to lay reviewers of the application.

**Short title and version number:** (maximum 70 characters - this will be inserted as header on all forms)  
In situ testing of antimicrobial nanocoatings v1

Please complete these details after you have booked the REC application for review.

**REC Name:**

Non-REC Studies: England

**REC Reference Number:**

21/HRA/0491

**Submission date:**

03/02/2021

### PART A: Core study information

#### 1. ADMINISTRATIVE DETAILS

**A1. Full title of the research:**

In situ testing of antimicrobial nanocoatings in Derriford Hospital sink traps

**A2-1. Educational projects**

Name and contact details of student(s):

**Student 1**

	Title	Forename/Initials	Surname
	Mr	James	Butler
Address	Derriford Research Facility		
	14 Research Way		
	Plymouth Science Park		
Post Code	PL6 8BU		
E-mail	james.butler@plymouth.ac.uk		
Telephone	01752584458		
Fax			

Give details of the educational course or degree for which this research is being undertaken:

Name and level of course/ degree:

PhD

Name of educational establishment:  
University of Plymouth

Name and contact details of academic supervisor(s):

**Academic supervisor 1**

	Title	Forename/Initials	Surname
	Dr	Alexander	Besinis
Address	Reynolds Building University of Plymouth Drake Circus		
Post Code	PL4 8AA		
E-mail	alexander.besinis@plymouth.ac.uk		
Telephone	01752586193		
Fax			

**Academic supervisor 2**

	Title	Forename/Initials	Surname
	Prof	Mathew	Upton
Address	Derriford Research Facility 14 Research Way Plymouth Science Park		
Post Code	PL6 8BU		
E-mail	mathew.upton@plymouth.ac.uk		
Telephone	01752584466		
Fax			

Please state which academic supervisor(s) has responsibility for which student(s):  
*Please click "Save now" before completing this table. This will ensure that all of the student and academic supervisor details are shown correctly.*

**Student(s)**

**Academic supervisor(s)**

**Student 1** Mr James Butler

- Dr Alexander Besinis
- Prof Mathew Upton

*A copy of a current CV for the student and the academic supervisor (maximum 2 pages of A4) must be submitted with the application.*

**A2-2. Who will act as Chief Investigator for this study?**

- Student
- Academic supervisor
- Other

**A3-1. Chief Investigator:**

	Title Forename/Initials Surname
	Mr James Butler
Post	PhD Student
Qualifications	BSc (Hons) Biomedical Science, MSc Biomedical Science (Immunology)
ORCID ID	0000 0003 1998 1219
Employer	University of Plymouth
Work Address	Derriford Research Facility 14 Research Way Plymouth Science Park
Post Code	PL6 8BU
Work E-mail	james.butler@plymouth.ac.uk
* Personal E-mail	
Work Telephone	01752584458
* Personal Telephone/Mobile	07495267933
Fax	

*\* This information is optional. It will not be placed in the public domain or disclosed to any other third party without prior consent.*

*A copy of a current CV (maximum 2 pages of A4) for the Chief Investigator must be submitted with the application.*

**A4. Who is the contact on behalf of the sponsor for all correspondence relating to applications for this project?**

*This contact will receive copies of all correspondence from REC and HRA/R&D reviewers that is sent to the CI.*

	Title Forename/Initials Surname
	Mrs Sarah C Jones
Address	University of Plymouth Level 2, Marine Building Drake Circus, Plymouth
Post Code	PL4 8AA
E-mail	plymouth.sponsor@plymouth.ac.uk
Telephone	01752588959
Fax	

**A5-1. Research reference numbers. Please give any relevant references for your study:**

Applicant's/organisation's own reference number, e.g. R & D (if available):

Sponsor's/protocol number: 2021-2554-1505

Protocol Version: 1

Protocol Date: 21/01/2021

Funder's reference number (enter the reference number or state not applicable): Not applicable

Project website:

**Registry reference number(s):**

*The UK Policy Framework for Health and Social Care Research sets out the principle of making information about research publicly available. Furthermore: Article 19 of the World Medical Association Declaration of Helsinki adopted in 2008 states that "every clinical trial must be registered on a publicly accessible database before recruitment of the first subject"; and the International Committee of Medical Journal Editors (ICMJE) will consider a clinical trial for publication only if it has been registered in an appropriate registry. Please see guidance for more information.*

International Standard Randomised Controlled Trial Number (ISRCTN):  
ClinicalTrials.gov Identifier (NCT number):

**Additional reference number(s):**

Ref.Number	Description	Reference Number
------------	-------------	------------------

**A5-2. Is this application linked to a previous study or another current application?**

Yes  No

Please give brief details and reference numbers.

**2. OVERVIEW OF THE RESEARCH**

*To provide all the information required by review bodies and research information systems, we ask a number of specific questions. This section invites you to give an overview using language comprehensible to lay reviewers and members of the public. Please read the guidance notes for advice on this section.*

**A6-1. Summary of the study.** Please provide a brief summary of the research (maximum 300 words) using language easily understood by lay reviewers and members of the public. Where the research is reviewed by a REC within the UK Health Departments' Research Ethics Service, this summary will be published on the Health Research Authority (HRA) website following the ethical review. Please refer to the question specific guidance for this question.

This study aims to test the performance of a coating for application to surfaces in plumbing to prevent or reduce bacterial colonisation. The coating itself has been developed as part of a PhD project aiming to address a problem in which bacteria are able to grow within sink traps (also known as U-bends), found directly below or behind sinks and receive wastewater. There is a well-characterised problem in which the sink trap escapes routine disinfection due to its position, but it is regularly exposed to a variety of substances and microbes. These microbes grow in the sink trap, producing complex sticky structures (biofilms) which further enable them to resist disinfection. This problem is even more serious in hospitals, where more dangerous pathogens (disease-causing microbes) are likely to be found, and the people in hospitals are likely to be physically vulnerable and may have compromised immune systems. For these reasons, bacterial persistence in hospitals sink traps may be particularly dangerous, with evidence suggesting a link between sink trap colonisation and patient disease and even death. The coating being developed is based around silver nanoparticles (hence the term 'nanocoating'), which are very small clusters of silver atoms with antimicrobial properties. By coating surfaces within the wastewater plumbing system with this silver nanocoating, it is hoped that the extent of bacterial survival and growth will be reduced. This has been tested experimentally within a laboratory environment as part of the PhD project using plastic discs, and the coating has been shown to be effective at both killing bacteria floating near it and preventing bacteria from attaching and forming a biofilm. The proposed study seeks to place these coated discs in real hospital sink traps and assess how they perform long-term in a more realistic environment.

**A6-2. Summary of main issues.** Please summarise the main ethical, legal, or management issues arising from your study and say how you have addressed them.

*Not all studies raise significant issues. Some studies may have straightforward ethical or other issues that can be identified and managed routinely. Others may present significant issues requiring further consideration by a REC, HRA, or other review body (as appropriate to the issue). Studies that present a minimal risk to participants may raise complex organisational or legal issues. You should try to consider all the types of issues that the different reviewers may need to consider.*

We do not foresee any legal or ethical issues related to this project. The study does not involve any human participants, either directly or indirectly, nor does it include any human tissues. Any interactions with patients or staff as part of this study would be limited to brief encounters within the hospital environment when sink traps are being fitted or removed. This would always be conducted in agreement with hospital staff and with total respect for patient confidentiality and space.

In terms of management issues, there are potential logistical matters to be discussed between the study team and the hospital estates team regarding the sourcing of replacement sink traps in which test specimens can be placed and the areas to be used as test sites. These are matters for discussion and there are no problems anticipated. The

nature of the study is low-impact in terms of presence in the hospital as test specimens are able to be left in situ and no further interaction is needed apart from at the time points proposed (on the scale of weeks).

All data collected will relate to bacterial numbers, identity and their genetic background, and the position of sinks around the hospital (e.g. whether a given sink trap is on a ward, in a side room, a WC, a kitchen area). No human materials are to be examined in any way. Any reporting or publication of results will not refer to spaces by name and will not provide information allowing this to be discovered; descriptions will be limited to the type of environment discussed.

### 3. PURPOSE AND DESIGN OF THE RESEARCH

**A7. Select the appropriate methodology description for this research. Please tick all that apply:**

- Case series/ case note review
- Case control
- Cohort observation
- Controlled trial without randomisation
- Cross-sectional study
- Database analysis
- Epidemiology
- Feasibility/ pilot study
- Laboratory study
- Metanalysis
- Qualitative research
- Questionnaire, interview or observation study
- Randomised controlled trial
- Other (please specify)

**A10. What is the principal research question/objective? Please put this in language comprehensible to a lay person.**

The principal research objective is to discover whether the silver nanocoating that has been developed and tested in the laboratory has effective antibacterial properties in the real-life hospital sink trap environment over a 12-week period.

**A11. What are the secondary research questions/objectives if applicable? Please put this in language comprehensible to a lay person.**

What bacteria are present in the hospital sink trap, and which of these bacteria (if any) are able to grow on the developed silver nanocoating?

**A12. What is the scientific justification for the research? Please put this in language comprehensible to a lay person.**

Previous published peer-reviewed research has demonstrated that hospital sink traps are routinely colonised by bacteria, are difficult to disinfect, and are linked to outbreaks of infectious diseases on hospital wards (Walker et al. 2014, Journal of Hospital Infection, DOI: 10.1016/j.jhin.2013.10.003; De Jong et al. 2019, Journal of Hospital Infection, DOI: 10.1016/j.jhin.2019.01.003). The use of sinks also creates droplets and aerosols, carrying bacteria out of the sink trap and into contact with patients and staff on the ward, and infecting surfaces (Kotay et al. 2018, Applied and Environmental Microbiology, DOI: 10.1128/AEM.01997-18). The presence of environments on hospital wards where bacteria are able to grow and mix is a particular concern because patients in hospitals are frequently elderly, vulnerable, and/or may have compromised immune systems. The mixing of bacteria in an environment such as a sink trap is also a concern from the point of view of antimicrobial resistance, as bacteria carrying genes allowing them to resist (i.e. not be killed by) antibiotics are able to 'share' their genes and spread the resistance across different bacteria. Due to these reasons, solutions to improve hospital infection prevention are needed. This study aims to test one potential solution which has the potential to make the surfaces within hospital sink traps more hostile to bacteria

and reduce their ability to persist.

**A13. Please summarise your design and methodology.** *It should be clear exactly what will happen to the research participant, how many times and in what order. Please complete this section in language comprehensible to the lay person. Do not simply reproduce or refer to the protocol. Further guidance is available in the guidance notes.*

Discs made of unplasticised polyvinyl chloride (uPVC), a polymer frequently used in plumbing, will be prepared in the laboratory at the Derriford Research Facility (DRF). Discs will be prepared with and without the study silver nanocoating, to provide a control surface without the appropriate coating. New, fresh, clean sink traps of the same design as routinely used in the hospital Trust will be procured and discs will be placed within them in the laboratory in an aseptic way; that is, using methods which minimise the extent of cross-contamination with other bacteria. By agreement with the hospital Estates team, these new sink traps containing test specimens will be fitted to hospital sinks and then left to be used as normal. At pre-defined time points of 1, 4, 8, 12 weeks after fitting, the chief investigator will come to the study sites and briefly detach each sink trap to recover a number of uncoated and coated discs. No other interventions at this stage are envisioned. The discs from each area at each time point will be returned to the containment level 2 (CL2) laboratory at the DRF for assessment of the extent of bacterial colonisation. These actions will be repeated at each time point until the final one (12 weeks post-fitting), at which point all nanocoated and uncoated discs will have been recovered.

Due to the nature of the laboratory work, preliminary data will be available immediately after (within a week of) each time point, so there will be an appreciation of the study's progress throughout. This may serve as interim data.

To address sample groups and sizes, we propose that study sites should consist of three groups: (1) hospital ward hand-washing sinks (clinical), (2) hospital toilet (staff or patient/public) hand-washing sinks (non-clinical), and (3) staff office or kitchen sinks (non-clinical). We propose three sinks in each location.

**A14-1. In which aspects of the research process have you actively involved, or will you involve, patients, service users, and/or their carers, or members of the public?**

- Design of the research
- Management of the research
- Undertaking the research
- Analysis of results
- Dissemination of findings
- None of the above

*Give details of involvement, or if none please justify the absence of involvement.*

Due to the nature of the study, not involving any human participants and not directly investigating humans, there is no clear scope for the involvement of patients, service users, their carers, or members of the public in this study.

#### 4. RISKS AND ETHICAL ISSUES

##### RESEARCH PARTICIPANTS

**A15. What is the sample group or cohort to be studied in this research?**

Select all that apply:

- Blood
- Cancer
- Cardiovascular
- Congenital Disorders
- Dementias and Neurodegenerative Diseases
- Diabetes

- Ear
- Eye
- Generic Health Relevance
- Infection
- Inflammatory and Immune System
- Injuries and Accidents
- Mental Health
- Metabolic and Endocrine
- Musculoskeletal
- Neurological
- Oral and Gastrointestinal
- Paediatrics
- Renal and Urogenital
- Reproductive Health and Childbirth
- Respiratory
- Skin
- Stroke

Gender: Male and female participants  
 Lower age limit: Years  
 Upper age limit: Years

**A17-1. Please list the principal inclusion criteria (list the most important, max 5000 characters).**

Not applicable.

**A17-2. Please list the principal exclusion criteria (list the most important, max 5000 characters).**

Not applicable.

**RESEARCH PROCEDURES, RISKS AND BENEFITS**

**A18. Give details of all non-clinical intervention(s) or procedure(s) that will be received by participants as part of the research protocol. These include seeking consent, interviews, non-clinical observations and use of questionnaires.**

Please complete the columns for each intervention/procedure as follows:

1. Total number of interventions/procedures to be received by each participant as part of the research protocol.
2. If this intervention/procedure would be routinely given to participants as part of their care outside the research, how many of the total would be routine?
3. Average time taken per intervention/procedure (minutes, hours or days)
4. Details of who will conduct the intervention/procedure, and where it will take place.

Intervention or procedure	1	2	3	4

**A19. Give details of any clinical intervention(s) or procedure(s) to be received by participants as part of the research protocol. These include uses of medicinal products or devices, other medical treatments or assessments, mental health interventions, imaging investigations and taking samples of human biological material. Include procedures which might be**

*received as routine clinical care outside of the research.*

Please complete the columns for each intervention/procedure as follows:

1. Total number of interventions/procedures to be received by each participant as part of the research protocol.
2. If this intervention/procedure would be routinely given to participants as part of their care outside the research, how many of the total would be routine?
3. Average time taken per intervention/procedure (minutes, hours or days).
4. Details of who will conduct the intervention/procedure, and where it will take place.

Intervention or procedure	1	2	3	4

**A20. Will you withhold an intervention or procedure, which would normally be considered a part of routine care?**

Yes     No

**A21. How long do you expect each participant to be in the study in total?**

Not applicable.

**A22. What are the potential risks and burdens for research participants and how will you minimise them?**

*For all studies, describe any potential adverse effects, pain, discomfort, distress, intrusion, inconvenience or changes to lifestyle. Only describe risks or burdens that could occur as a result of participation in the research. Say what steps would be taken to minimise risks and burdens as far as possible.*

No humans are participating in this research.

**A23. Will interviews/ questionnaires or group discussions include topics that might be sensitive, embarrassing or upsetting, or is it possible that criminal or other disclosures requiring action could occur during the study?**

Yes     No

**A24. What is the potential for benefit to research participants?**

This study does not involve any human participants.

**A25. What arrangements are being made for continued provision of the intervention for participants, if appropriate, once the research has finished? May apply to any clinical intervention, including a drug, medical device, mental health intervention, complementary therapy, physiotherapy, dietary manipulation, lifestyle change, etc.**

This study does not involve any human participants.

**A26. What are the potential risks for the researchers themselves? (if any)**

The potential risks are low and the researchers (primarily the chief investigator) will be using appropriate personal protective equipment (PPE) when handling sink traps and their contents. Once specimens are removed and taken back to our laboratory, normal containment procedures will apply and all researchers are experienced in working within a microbiology laboratory.

**RECRUITMENT AND INFORMED CONSENT**

*In this section we ask you to describe the recruitment procedures for the study. Please give separate details for different study groups where appropriate.*



**A27-1. How will potential participants, records or samples be identified? Who will carry this out and what resources will be used?** *For example, identification may involve a disease register, computerised search of GP records, or review of medical records. Indicate whether this will be done by the direct healthcare team or by researchers acting under arrangements with the responsible care organisation(s).*

The sink traps that will serve as study sites will be selected by the research team, in discussion with and with the agreement of the hospital Estates team and any other relevant personnel. The chief investigator will be ultimately responsible for arranging for provision of the resources needed (mainly the new sink traps).

**A27-2. Will the identification of potential participants involve reviewing or screening the identifiable personal information of patients, service users or any other person?**

Yes  No

*Please give details below:*

**A28. Will any participants be recruited by publicity through posters, leaflets, adverts or websites?**

Yes  No

**A29. How and by whom will potential participants first be approached?**

This study does not involve any human participants.

**A30-1. Will you obtain informed consent from or on behalf of research participants?**

Yes  No

*If you will be obtaining consent from adult participants, please give details of who will take consent and how it will be done, with details of any steps to provide information (a written information sheet, videos, or interactive material). Arrangements for adults unable to consent for themselves should be described separately in Part B Section 6, and for children in Part B Section 7.*

*If you plan to seek informed consent from vulnerable groups, say how you will ensure that consent is voluntary and fully informed.*

*If you are not obtaining consent, please explain why not.*

This study does not involve any human participants.

*Please enclose a copy of the information sheet(s) and consent form(s).*

**A32. Will you recruit any participants who are involved in current research or have recently been involved in any research prior to recruitment?**

Yes  
 No  
 Not Known

**A34. What arrangements will you make to ensure participants receive any information that becomes available during the course of the research that may be relevant to their continued participation?**

This study does not involve any human participants.

**CONFIDENTIALITY**

In this section, personal data means any data relating to a participant who could potentially be identified. It includes pseudonymised data capable of being linked to a participant through a unique code number.

#### Storage and use of personal data during the study

**A36. Will you be undertaking any of the following activities at any stage (including in the identification of potential participants)?** (Tick as appropriate)

- Access to medical records by those outside the direct healthcare team
- Access to social care records by those outside the direct social care team
- Electronic transfer by magnetic or optical media, email or computer networks
- Sharing of personal data with other organisations
- Export of personal data outside the EEA
- Use of personal addresses, postcodes, faxes, emails or telephone numbers
- Publication of direct quotations from respondents
- Publication of data that might allow identification of individuals
- Use of audio/visual recording devices
- Storage of personal data on any of the following:
  - Manual files (includes paper or film)
  - NHS computers
  - Social Care Service computers
  - Home or other personal computers
  - University computers
  - Private company computers
  - Laptop computers

Further details:

**A37. Please describe the physical security arrangements for storage of personal data during the study?**

No personal data will be accessed or collected during the study.

**A38. How will you ensure the confidentiality of personal data?** Please provide a general statement of the policy and procedures for ensuring confidentiality, e.g. anonymisation or pseudonymisation of data.

No personal data will be accessed or collected during the study.

**A40. Who will have access to participants' personal data during the study?** Where access is by individuals outside the direct care team, please justify and say whether consent will be sought.

No personal data will be accessed or collected during the study.

#### Storage and use of data after the end of the study

**A41. Where will the data generated by the study be analysed and by whom?**

Data generated by the study will be analysed by the Chief Investigator, James Butler, primarily at the Derriford Research Facility. Data will be handled in accordance with University of Plymouth data management plans already in place.

**A42. Who will have control of and act as the custodian for the data generated by the study?**

	Title Forename/Initials Surname
	Mr James Butler
Post	PhD Student
Qualifications	BSc (Hons) Biomedical Science, MSc Biomedical Science (Immunology)
Work Address	Derriford Research Facility 119 14 Research Way Plymouth Science Park
Post Code	PL6 8BU
Work Email	james.butler@plymouth.ac.uk
Work Telephone	01752584458
Fax	

**A43. How long will personal data be stored or accessed after the study has ended?**

- Less than 3 months  
 3 – 6 months  
 6 – 12 months  
 12 months – 3 years  
 Over 3 years

*If longer than 12 months, please justify:*

No personal data will be collected as part of this study. Of the scientific laboratory data collected, future presentation at scientific conferences and submission to peer-reviewed journals is envisaged so data will need to be held until those activities are complete. Data will be handled in accordance with University of Plymouth data management plans already in place.

**A44. For how long will you store research data generated by the study?**

Years: 10  
Months: 0

**A45. Please give details of the long term arrangements for storage of research data after the study has ended. Say where data will be stored, who will have access and the arrangements to ensure security.**

Data will be kept within the Microsoft OneDrive for Business cloud storage service assigned to the Chief Investigator, James Butler. Access to OneDrive for Business is restricted using University credentials, and encrypted in transit and at rest. Data is backed up using OneDrive version history. Data will be handled in accordance with University of Plymouth data management plans already in place. <https://support.microsoft.com/en-us/office/how-onedrive-safeguard-your-data-in-the-cloud-23c6ea94-3608-48d7-8bf0-80e142edd1e1>

**INCENTIVES AND PAYMENTS****A46. Will research participants receive any payments, reimbursement of expenses or any other benefits or incentives for taking part in this research?**

- Yes     No

**A47. Will individual researchers receive any personal payment over and above normal salary, or any other benefits or incentives, for taking part in this research?**

Yes  No

**A48. Does the Chief Investigator or any other investigator/collaborator have any direct personal involvement (e.g. financial, share holding, personal relationship etc.) in the organisations sponsoring or funding the research that may give rise to a possible conflict of interest?**

Yes  No

#### NOTIFICATION OF OTHER PROFESSIONALS

**A49-1. Will you inform the participants' General Practitioners (and/or any other health or care professional responsible for their care) that they are taking part in the study?**

Yes  No

*If Yes, please enclose a copy of the information sheet/letter for the GP/health professional with a version number and date.*

#### PUBLICATION AND DISSEMINATION

**A50. Will the research be registered on a public database?**

*The UK Policy Framework for Health and Social Care Research sets out the principle of making information about research publicly available. Furthermore: Article 19 of the World Medical Association Declaration of Helsinki adopted in 2008 states that "every clinical trial must be registered on a publicly accessible database before recruitment of the first subject"; and the International Committee of Medical Journal Editors (ICMJE) will consider a clinical trial for publication only if it has been registered in an appropriate registry. Please see guidance for more information.*

Yes  No

*Please give details, or justify if not registering the research.*

This study does not involve any human participants and does not meet the definitions above, and the study team therefore does not deem it appropriate to register the study on any public database.

*Please ensure that you have entered registry reference number(s) in question A5-1.*

**A51. How do you intend to report and disseminate the results of the study? Tick as appropriate:**

- Peer reviewed scientific journals
- Internal report
- Conference presentation
- Publication on website
- Other publication
- Submission to regulatory authorities
- Access to raw data and right to publish freely by all investigators in study or by Independent Steering Committee on behalf of all investigators
- No plans to report or disseminate the results
- Other (please specify)

The doctoral thesis of the Chief Investigator

**A52. If you will be using identifiable personal data, how will you ensure that anonymity will be maintained when publishing the results?**

No personal data will be collected.

**A53. Will you inform participants of the results?**

Yes  No

*Please give details of how you will inform participants or justify if not doing so.*  
This study does not involve human participants.

## 5. Scientific and Statistical Review

**A54. How has the scientific quality of the research been assessed? Tick as appropriate:**

- Independent external review
- Review within a company
- Review within a multi-centre research group
- Review within the Chief Investigator's institution or host organisation
- Review within the research team
- Review by educational supervisor
- Other

*Justify and describe the review process and outcome. If the review has been undertaken but not seen by the researcher, give details of the body which has undertaken the review:*

The PhD funding supporting this project was awarded to Dr Alexander Besinis as Director of Studies following an internal competition conducted at the University of Plymouth. There have been multiple discussions within the research team, both face-to-face, through email and through video conferencing, regarding the study design and the quality of the science involved.

*For all studies except non-doctoral student research, please enclose a copy of any available scientific critique reports, together with any related correspondence.*

*For non-doctoral student research, please enclose a copy of the assessment from your educational supervisor/ institution.*

**A56. How have the statistical aspects of the research been reviewed? Tick as appropriate:**

- Review by independent statistician commissioned by funder or sponsor
- Other review by independent statistician
- Review by company statistician
- Review by a statistician within the Chief Investigator's institution
- Review by a statistician within the research team or multi-centre group
- Review by educational supervisor
- Other review by individual with relevant statistical expertise
- No review necessary as only frequencies and associations will be assessed – details of statistical input not required

*In all cases please give details below of the individual responsible for reviewing the statistical aspects. If advice has been provided in confidence, give details of the department and institution concerned.*

	Title Forename/Initials Surname
	Dr Alexander Besinis
Department	School of Engineering, Computing and Mathematics
Institution	University of Plymouth
Work Address	Reynolds Building, University of Plymouth
	Drake Circus
	Plymouth
Post Code	PL4 8AA
Telephone	01752586193
Fax	
Mobile	
E-mail	alexander.besinis@plymouth.ac.uk

Please enclose a copy of any available comments or reports from a statistician.

**A57. What is the primary outcome measure for the study?**

The primary outcome measure will be the numbers of bacteria recovered from test discs at each time point.

**A58. What are the secondary outcome measures?(if any)**

The secondary outcome measures will be the identities of the bacteria growing within the test sink traps and on discs and the presence of genes related to antimicrobial resistance.

**A59. What is the sample size for the research? How many participants/samples/data records do you plan to study in total? If there is more than one group, please give further details below.**

Total UK sample size:	324
Total international sample size (including UK):	324
Total in European Economic Area:	0

*Further details:*

Maximum sample size = 3 types of study site x 3 sinks per site x 4 time points x 3 experimental groups x 3 replicate discs per group = 324. The number of replicates within experimental groups could be reduced to 1 or 2 to reduce this total, as 3 sinks per site are being investigated. Time points envisaged are: 1, 4, 8 and 12 weeks. If the number of replicate discs per group were reduced to 1 or 2, the maximum sample size would be 108 or 216, respectively. Sample size could also be adjusted by targeting 3 ward hand washing sinks, but only 1 sink in each of the other areas.

**A60. How was the sample size decided upon? If a formal sample size calculation was used, indicate how this was done, giving sufficient information to justify and reproduce the calculation.**

The sample size was decided upon based on the knowledge and use of standard laboratory methods in microbiology, for example the standard use of three replicates per group. The time points were decided to cover a long-term efficacy study of the discs, with an analysis of efficacy in the range of weeks-months needed (as a comparison with the laboratory efficacy results based on hours-days). The number of experimental groups is a fixed value as they include two controls (one uncoated disc control and one no-particle coated control) and the experimental group of interest. The number of study sites was decided upon based on a need to examine efficacy of discs placed in sinks situated in a range of different locations, as it is likely that the microbial composition, use frequency and other relevant biological factors will vary between locations.

**A61. Will participants be allocated to groups at random?**

Yes  No

**A62. Please describe the methods of analysis (statistical or other appropriate methods, e.g. for qualitative research) by which the data will be evaluated to meet the study objectives.**

In the first instance, the numbers of bacterial colonies grown (colony-forming units (CFU) per millilitre) will be compared by the one-way analysis of variances (ANOVA) test with post-hoc Dunnett's test for multiple comparisons. This will allow the research team to assess whether differences in CFU numbers are statistically significant. The identities of bacteria as ascertained by sequencing will be regarded as qualitative data for comparison, but the relative abundances of different taxa (as given by number of sequencing reads) can be compared directly.

**6. MANAGEMENT OF THE RESEARCH**

**A63. Other key investigators/collaborators.** Please include all grant co-applicants, protocol co-authors and other key members of the Chief Investigator's team, including non-doctoral student researchers.

Title Forename/Initials Surname
Post
Qualifications
Employer
Work Address
Post Code
Telephone
Fax
Mobile
Work Email

**A64. Details of research sponsor(s)**

**A64-1. Sponsor**

**Lead Sponsor**

Status:  NHS or HSC care organisation      Commercial status:  Non-Commercial  
 Academic  
 Pharmaceutical industry  
 Medical device industry  
 Local Authority  
 Other social care provider (including voluntary sector or private organisation)  
 Other

*If Other, please specify:*

**Contact person**

Name of organisation	University of Plymouth
Given name	Sarah
Family name	Jones
Address	Level 2, Marine Building, Drake Circus
Town/city	Plymouth
Post code	PL4 8AA
Country	United Kingdom
Telephone	01752588959
Fax	
E-mail	plymouth.sponsor@plymouth.ac.uk

**A65. Has external funding for the research been secured?**

*Please tick at least one check box.*

- Funding secured from one or more funders
- External funding application to one or more funders in progress
- No application for external funding will be made

What type of research project is this?

- Standalone project
- Project that is part of a programme grant
- Project that is part of a Centre grant
- Project that is part of a fellowship/ personal award/ research training award
- Other

Other – please state:

**A66. Has responsibility for any specific research activities or procedures been delegated to a subcontractor (other than a co-sponsor listed in A64-1) ? Please give details of subcontractors if applicable.**

- Yes  No

**A67. Has this or a similar application been previously rejected by a Research Ethics Committee in the UK or another country?**

- Yes  No

*Please provide a copy of the unfavourable opinion letter(s). You should explain in your answer to question A6-2 how the reasons for the unfavourable opinion have been addressed in this application.*

**A68-1. Give details of the lead NHS R&D contact for this research:**

	Title	Forename/Initials	Surname
	Dr	Helen	Neilens
Organisation	University Hospitals Plymouth NHS Trust		
Address	Level 2, MSCP, Bircham Park Offices		



1 Roscoff Rise  
Plymouth  
Post Code PL6 5FP  
Work Email hneilens@nhs.net  
Telephone 01752439991  
Fax  
Mobile

Details can be obtained from the NHS R&D Forum website: <http://www.rdforum.nhs.uk>

**A69-1. How long do you expect the study to last in the UK?**

Planned start date: 01/06/2021

Planned end date: 01/09/2021

Total duration:

Years: 0 Months: 3 Days: 1

**A71-1. Is this study?**

- Single centre  
 Multicentre

**A71-2. Where will the research take place? (Tick as appropriate)**

- England  
 Scotland  
 Wales  
 Northern Ireland  
 Other countries in European Economic Area

Total UK sites in study

**Does this trial involve countries outside the EU?**

- Yes  No

**A72. Which organisations in the UK will host the research? Please indicate the type of organisation by ticking the box and give approximate numbers if known:**

- NHS organisations in England 1  
 NHS organisations in Wales  
 NHS organisations in Scotland  
 HSC organisations in Northern Ireland  
 GP practices in England  
 GP practices in Wales  
 GP practices in Scotland  
 GP practices in Northern Ireland  
 Joint health and social care agencies (eg community mental health teams)

- Local authorities
- Phase 1 trial units
- Prison establishments
- Probation areas
- Independent (private or voluntary sector) organisations
- Educational establishments
- Independent research units
- Other (give details)

Total UK sites in study: 1

**A73-1. Will potential participants be identified through any organisations other than the research sites listed above?**

Yes  No

**A74. What arrangements are in place for monitoring and auditing the conduct of the research?**

The full supervisory team of the chief investigator (PhD student James Butler) will be monitoring and auditing the conduct of the research. This team consists of Dr Alexander Besinis, Prof Mathew Upton, and Dr Lewis Jones.

**A75-1. What arrangements will be made to review interim safety and efficacy data from the trial? Will a formal data monitoring committee or equivalent body be convened?**

Due to the nature of the study, interim safety and efficacy data are not relevant. A formal data monitoring committee will not be convened.

*If a formal DMC is to be convened, please forward details of the membership and standard operating procedures to the Research Ethics Committee when available. The REC should also be notified of DMC recommendations and receive summary reports of interim analyses.*

**A75-2. What are the criteria for electively stopping the trial or other research prematurely?**

**A76. Insurance/ indemnity to meet potential legal liabilities**

*Note: in this question to NHS indemnity schemes include equivalent schemes provided by Health and Social Care (HSC) in Northern Ireland*

**A76-1. What arrangements will be made for insurance and/or indemnity to meet the potential legal liability of the sponsor(s) for harm to participants arising from the management of the research? Please tick box(es) as applicable.**

*Note: Where a NHS organisation has agreed to act as sponsor or co-sponsor, indemnity is provided through NHS schemes. Indicate if this applies (there is no need to provide documentary evidence). For all other sponsors, please describe the arrangements and provide evidence.*

- NHS indemnity scheme will apply (NHS sponsors only)
- Other insurance or indemnity arrangements will apply (give details below)

The University of Plymouth has in force a Public Liability Policy and the activities here are included within that coverage. See link to University of Plymouth insurance certificates: <https://www.plymouth.ac.uk/about-us/university-structure/service-areas/procurement/insurance-certificates>

Please enclose a copy of relevant documents.

**A76-2. What arrangements will be made for insurance and/ or indemnity to meet the potential legal liability of the sponsor(s) or employer(s) for harm to participants arising from the design of the research? Please tick box(es) as applicable.**

*Note: Where researchers with substantive NHS employment contracts have designed the research, indemnity is provided through NHS schemes. Indicate if this applies (there is no need to provide documentary evidence). For other protocol authors (e.g. company employees, university members), please describe the arrangements and provide evidence.*

- NHS indemnity scheme will apply (protocol authors with NHS contracts only)
- Other insurance or indemnity arrangements will apply (give details below)

The University of Plymouth has in force a Public Liability Policy and the activities here are included within that coverage. See link to University of Plymouth insurance certificates: <https://www.plymouth.ac.uk/about-us/university-structure/service-areas/procurement/insurance-certificates>

Please enclose a copy of relevant documents.

**A76-3. What arrangements will be made for insurance and/ or indemnity to meet the potential legal liability of investigators/collaborators arising from harm to participants in the conduct of the research?**

*Note: Where the participants are NHS patients, indemnity is provided through the NHS schemes or through professional indemnity. Indicate if this applies to the whole study (there is no need to provide documentary evidence). Where non-NHS sites are to be included in the research, including private practices, please describe the arrangements which will be made at these sites and provide evidence.*

- NHS indemnity scheme or professional indemnity will apply (participants recruited at NHS sites only)
- Research includes non-NHS sites (give details of insurance/ indemnity arrangements for these sites below)

The University of Plymouth has in force a Public Liability Policy and the activities here are included within that coverage. See link to University of Plymouth insurance certificates: <https://www.plymouth.ac.uk/about-us/university-structure/service-areas/procurement/insurance-certificates>

Please enclose a copy of relevant documents.

**A77. Has the sponsor(s) made arrangements for payment of compensation in the event of harm to the research participants where no legal liability arises?**

- Yes  No

Please enclose a copy of relevant documents.

**A78. Could the research lead to the development of a new product/process or the generation of intellectual property?**

- Yes  No  Not sure

**PART C: Overview of research sites**

**Please enter details of the host organisations (Local Authority, NHS or other) in the UK that will be responsible for the research sites.** *For further information please refer to guidance.*

Investigator identifier	Research site	Investigator Name
IN1	<input checked="" type="radio"/> NHS/HSC Site <input type="radio"/> Non-NHS/HSC Site	
	Organisation name      UNIVERSITY HOSPITALS PLYMOUTH NHS TRUST Address                      DERRIFORD HOSPITAL DERRIFORD ROAD DERRIFORD PLYMOUTH Post Code                      PL6 8DH Country                        ENGLAND	Forename                      Lewis Middle name Family name                  Jones Email                            lewis.jones2@nhs.net Qualification                  MB BCh 2007 University (MD...)                          of Wales Country                         United Kingdom

**PART D: Declarations****D1. Declaration by Chief Investigator**

1. The information in this form is accurate to the best of my knowledge and belief and I take full responsibility for it.
2. I undertake to fulfil the responsibilities of the chief investigator for this study as set out in the UK Policy Framework for Health and Social Care Research.
3. I undertake to abide by the ethical principles underlying the Declaration of Helsinki and good practice guidelines on the proper conduct of research.
4. If the research is approved I undertake to adhere to the study protocol, the terms of the full application as approved and any conditions set out by review bodies in giving approval.
5. I undertake to notify review bodies of substantial amendments to the protocol or the terms of the approved application, and to seek a favourable opinion from the main REC before implementing the amendment.
6. I undertake to submit annual progress reports setting out the progress of the research, as required by review bodies.
7. I am aware of my responsibility to be up to date and comply with the requirements of the law and relevant guidelines relating to security and confidentiality of patient or other personal data, including the need to register when necessary with the appropriate Data Protection Officer. I understand that I am not permitted to disclose identifiable data to third parties unless the disclosure has the consent of the data subject or, in the case of patient data in England and Wales, the disclosure is covered by the terms of an approval under Section 251 of the NHS Act 2006.
8. I understand that research records/data may be subject to inspection by review bodies for audit purposes if required.
9. I understand that any personal data in this application will be held by review bodies and their operational managers and that this will be managed according to the principles established in the Data Protection Act 2018.
10. I understand that the information contained in this application, any supporting documentation and all correspondence with review bodies or their operational managers relating to the application:
  - ◊ Will be held by the REC (where applicable) until at least 3 years after the end of the study; and by NHS R&D offices (where the research requires NHS management permission) in accordance with the NHS Code of Practice on Records Management.
  - ◊ May be disclosed to the operational managers of review bodies, or the appointing authority for the REC (where applicable), in order to check that the application has been processed correctly or to investigate any complaint.
  - ◊ May be seen by auditors appointed to undertake accreditation of RECs (where applicable).
  - ◊ Will be subject to the provisions of the Freedom of Information Acts and may be disclosed in response to requests made under the Acts except where statutory exemptions apply.
  - ◊ May be sent by email to REC members.
11. I understand that information relating to this research, including the contact details on this application, may be held on national research information systems, and that this will be managed according to the principles established in the Data Protection Act 2018.
12. Where the research is reviewed by a REC within the UK Health Departments Research Ethics Service, I understand that the summary of this study will be published on the website of the Health Research Authority (HRA) together with the contact point for enquiries named below. Publication will take place no earlier than 3 months after the issue of the ethics committee's final opinion or the withdrawal of the application.

**Contact point for publication** *(Not applicable for R&D Forms)*

*HRA would like to include a contact point with the published summary of the study for those wishing to seek further*

information. We would be grateful if you would indicate one of the contact points below.

- Chief Investigator
- Sponsor
- Study co-ordinator
- Student
- Other – please give details
- None

**Access to application for training purposes** (Not applicable for R&D Forms)

Optional – please tick as appropriate:

I would be content for members of other RECs to have access to the information in the application in confidence for training purposes. All personal identifiers and references to sponsors, funders and research units would be removed.

This section was signed electronically by Mr James Butler on 03/02/2021 16:09.

Job Title/Post:            PhD Student  
Organisation:            University of Plymouth  
Email:                      james.butler@plymouth.ac.uk

**D2. Declaration by the sponsor's representative**

*If there is more than one sponsor, this declaration should be signed on behalf of the co-sponsors by a representative of the lead sponsor named at A64-1.*

I confirm that:

1. This research proposal has been discussed with the Chief Investigator and agreement in principle to sponsor the research is in place.
2. An appropriate process of scientific critique has demonstrated that this research proposal is worthwhile and of high scientific quality.
3. Any necessary indemnity or insurance arrangements, as described in question A76, will be in place before this research starts. Insurance or indemnity policies will be renewed for the duration of the study where necessary.
4. Arrangements will be in place before the study starts for the research team to access resources and support to deliver the research as proposed.
5. Arrangements to allocate responsibilities for the management, monitoring and reporting of the research will be in place before the research starts.
6. The responsibilities of sponsors set out in the UK Policy Framework for Health and Social Care Research will be fulfilled in relation to this research.

*Please note: The declarations below do not form part of the application for approval above. They will not be considered by the Research Ethics Committee.*

7. Where the research is reviewed by a REC within the UK Health Departments Research Ethics Service, I understand that the summary of this study will be published on the website of the National Research Ethics Service (NRES), together with the contact point for enquiries named in this application. Publication will take place no earlier than 3 months after issue of the ethics committee's final opinion or the withdrawal of the application.
8. Specifically, for submissions to the Research Ethics Committees (RECs) I declare that any and all clinical trials approved by the HRA since 30th September 2013 (as defined on IRAS categories as clinical trials of medicines, devices, combination of medicines and devices or other clinical trials) have been registered on a publically accessible register in compliance with the HRA registration requirements for the UK, or that any deferral granted by the HRA still applies.

This section was signed electronically by Mrs Sarah Jones on 03/02/2021 16:30.

Job Title/Post: Research Governance Specialist  
Organisation: University of Plymouth  
Email: plymouth.sponsor@plymouth.ac.uk

**D3. Declaration for student projects by academic supervisor(s)**

1. I have read and approved both the research proposal and this application. I am satisfied that the scientific content of the research is satisfactory for an educational qualification at this level.
2. I undertake to fulfil the responsibilities of the supervisor for this study as set out in the UK Policy Framework for Health and Social Care Research.
3. I take responsibility for ensuring that this study is conducted in accordance with the ethical principles underlying the Declaration of Helsinki and good practice guidelines on the proper conduct of research, in conjunction with clinical supervisors as appropriate.
4. I take responsibility for ensuring that the applicant is up to date and complies with the requirements of the law and relevant guidelines relating to security and confidentiality of patient and other personal data, in conjunction with clinical supervisors as appropriate.

**Academic supervisor 1**

This section was signed electronically by Dr Mathew Upton on 03/02/2021 16:08.

Job Title/Post: Professor of medical microbiology  
Organisation: University of Plymouth  
Email: mathew.upton@plymouth.ac.uk

**Academic supervisor 2**

This section was signed electronically by Dr Alexandros Besinis on 03/02/2021 17:08.

Job Title/Post: Project supervisor  
Organisation: Plymouth University  
Email: alexander.besinis@plymouth.ac.uk





### **C.3 Approval from the Health Research Authority**

Following the submission of the IRAS application form, full approval was given by the NHS Health Research Authority (see next page).

Mr James Butler  
Derriford Research Facility  
14 Research Way  
Plymouth Science Park  
PL6 8BU

Email: [approvals@hra.nhs.uk](mailto:approvals@hra.nhs.uk)

08 February 2021

Dear Mr Butler

**HRA and Health and Care  
Research Wales (HCRW)  
Approval Letter**

<b>Study title:</b>	<b>In situ testing of antimicrobial nanocoatings in Derriford Hospital sink traps</b>
<b>IRAS project ID:</b>	<b>293899</b>
<b>Protocol number:</b>	<b>2021-2554-1505</b>
<b>REC reference:</b>	<b>21/HRA/0491</b>
<b>Sponsor</b>	<b>University of Plymouth</b>

I am pleased to confirm that [HRA and Health and Care Research Wales \(HCRW\) Approval](#) has been given for the above referenced study, on the basis described in the application form, protocol, supporting documentation and any clarifications received. You should not expect to receive anything further relating to this application.

Please now work with participating NHS organisations to confirm capacity and capability, in line with the instructions provided in the "Information to support study set up" section towards the end of this letter.

**How should I work with participating NHS/HSC organisations in Northern Ireland and Scotland?**

HRA and HCRW Approval does not apply to NHS/HSC organisations within Northern Ireland and Scotland.

If you indicated in your IRAS form that you do have participating organisations in either of these devolved administrations, the final document set and the study wide governance report (including this letter) have been sent to the coordinating centre of each participating nation. The relevant national coordinating function/s will contact you as appropriate.

Please see [IRAS Help](#) for information on working with NHS/HSC organisations in Northern Ireland and Scotland.

### **How should I work with participating non-NHS organisations?**

HRA and HCRW Approval does not apply to non-NHS organisations. You should work with your non-NHS organisations to [obtain local agreement](#) in accordance with their procedures.

### **What are my notification responsibilities during the study?**

The “[After HRA Approval – guidance for sponsors and investigators](#)” document on the HRA website gives detailed guidance on reporting expectations for studies with HRA and HCRW Approval, including:

- Registration of Research
- Notifying amendments
- Notifying the end of the study

The [HRA website](#) also provides guidance on these topics and is updated in the light of changes in reporting expectations or procedures.

### **Who should I contact for further information?**

Please do not hesitate to contact me for assistance with this application. My contact details are below.

Your IRAS project ID is **293899**. Please quote this on all correspondence.

Yours sincerely,  
Chris King

Approvals Specialist

Email: [approvals@hra.nhs.uk](mailto:approvals@hra.nhs.uk)

Copy to: *Mrs Sarah C Jones*