

2020-05-01

# Japanese Marine Life A Practical Training Guide in Marine Biology

Inaba, K

<https://pearl.plymouth.ac.uk/handle/10026.1/22420>

---

Springer Nature

---

*All content in PEARL is protected by copyright law. Author manuscripts are made available in accordance with publisher policies. Please cite only the published version using the details provided on the item record or document. In the absence of an open licence (e.g. Creative Commons), permissions for further reuse of content should be sought from the publisher or author.*



Kazuo Inaba  
Jason M. Hall-Spencer  
*Editors*

# Japanese Marine Life

A Practical Training Guide  
in Marine Biology



Springer

---

# Japanese Marine Life

---

Kazuo Inaba • Jason M. Hall-Spencer  
Editors

# Japanese Marine Life

A Practical Training Guide in Marine  
Biology

 Springer

*Editors*

Kazuo Inaba  
Shimoda Marine Research Center  
University of Tsukuba  
Shimoda, Shizuoka, Japan

Jason M. Hall-Spencer  
School of Biological and Marine Sciences  
University of Plymouth  
Plymouth, UK

ISBN 978-981-15-1325-1      ISBN 978-981-15-1326-8 (eBook)  
<https://doi.org/10.1007/978-981-15-1326-8>

© Springer Nature Singapore Pte Ltd. 2020

This work is subject to copyright. All rights are reserved by the Publisher, whether the whole or part of the material is concerned, specifically the rights of translation, reprinting, reuse of illustrations, recitation, broadcasting, reproduction on microfilms or in any other physical way, and transmission or information storage and retrieval, electronic adaptation, computer software, or by similar or dissimilar methodology now known or hereafter developed.

The use of general descriptive names, registered names, trademarks, service marks, etc. in this publication does not imply, even in the absence of a specific statement, that such names are exempt from the relevant protective laws and regulations and therefore free for general use.

The publisher, the authors, and the editors are safe to assume that the advice and information in this book are believed to be true and accurate at the date of publication. Neither the publisher nor the authors or the editors give a warranty, expressed or implied, with respect to the material contained herein or for any errors or omissions that may have been made. The publisher remains neutral with regard to jurisdictional claims in published maps and institutional affiliations.

Cover illustration: Upper: Christmas tree worms *Spirobranchus giganteus*, living in the coral *Porites lutea* (Photo taken in Sesoko, Okinawa, Japan, by Kazuo Inaba).

Lower: Japanese kelp *Saccharina japonica* (photo taken in Muroran, Hokkaido, Japan; provided by Chikako Nagasato and Hiromori Shimabukuro)

This Springer imprint is published by the registered company Springer Nature Singapore Pte Ltd.  
The registered company address is: 152 Beach Road, #21-01/04 Gateway East, Singapore 189721, Singapore

---

## Preface

The ocean is the cradle of life on Earth. Curious humans have always asked questions. Where are we from? What was the first form of life? How did plants and animals evolve? How does life work? How do we share Earth with all the myriad organisms in the sea, land, and sky? A study of marine life may answer all these questions.

Marine biology is interdisciplinary and includes life science, oceanography, fisheries science, geoscience, Earth and space science, coastal and land engineering, conservation, economics, human welfare, and even political sciences. It has contributed to our understanding of the basic principles of biology, showing how life evolved and diversified from its origins in the ocean. Most of the ocean remains unexplored, and so there remain many marine organisms that have never been seen or described; with this comes the excitement of the unknown. Given the wonder and importance of the oceans to our planet, it has been a great pleasure to work with international experts to bring you this book on Japanese Marine Life. What comes through strongly is the importance of understanding of marine life as we progress through the coming decades.

Japan is an extensive island archipelago, surrounded by the North Pacific Ocean, the Sea of Japan, the Sea of Okhotsk, and the East China Sea, and sits astride multiple tectonic plates. Her varied coasts are washed by powerful ocean currents such as the Oyashio and the Kuroshio that give the region an exceptionally high marine biological diversity. Japanese people are highly dependent on seafood—they have a unique food culture and world leading fisheries and aquaculture expertise. This helps explain why there are so many marine research stations in Japan.

We have worked at opposite ends of the marine biology spectrum; one of us dedicated to finding out how cells work, the other documenting ecosystem function. We share the idea that marine biology is an essential field of science; it is of fundamental importance to society as we strive for solutions to sustain healthy, productive, and diverse seas. Our marine connections are close, having spent over 30 years working and teaching together at marine laboratories on the shores of Japan (Shimoda) and the United Kingdom (Plymouth). Through an international collaboration led by the University of Tsukuba, and whilst forming the Japanese Association for Marine Biology, we came to feel that although education in marine biology is important regionally, it is indispensable globally because the ocean, and solutions for sustainable use, are interconnected. Japan had a long history of isolationism, but

that has now changed; today, many international students visit to learn marine biology, and this is the main reason for publishing this book.

The ocean accounts for over 97% of the living space on Earth and it drives processes such as water, heat, and carbon cycling that keep our planet habitable. People can mistake the immensity of the ocean for inviolability, yet the seas are in crisis through overfishing, climate change, and biodiversity loss. How well can the ocean continue to function under the pressures of invasive species, acidification, deoxygenation, and heat waves? When we look back at the history of this planet, we should realize that now is the time for scientists and non-scientists to learn more about the ocean and life within it.

Whilst many predictions are pessimistic, we remain optimistic. This is because the young generation will surely learn from the past and present to open the way for a better future for the ocean and its ability to support life on Earth. We hope this textbook will help people on their journey of discovery about marine biology and the diversity of flora, fauna, and marine ecosystems that occur around Japan. The publication of this textbook was supported by the University of Tsukuba, including the International Education and Research Laboratory Program. We are indebted to all the authors in this book, who work at marine stations dotted around the 29,751 km long coastline of Japan.

Shizuoka, Japan  
Plymouth, UK

Kazuo Inaba  
Jason M. Hall-Spencer

---

## Acknowledgments

The publication of this book was supported in part by an International Education and Research Laboratory Program from the University of Tsukuba. We thank all the contributors in this book. In particular, Ben Harvey, Abigail McQuatters-Gollop, Shigeki Wada and Koetsu Kon who helped us in the final editing process.



---

# Contents

## Part I Japanese Marine Flora and Fauna

<b>1 Introduction to Marine Biology</b> . . . . .	3
Kazuo Inaba and Jason M. Hall-Spencer	
<b>2 Marine Life Members</b> . . . . .	17
Kazuo Inaba	
<b>3 Basic Taxonomy of Marine Organisms</b> . . . . .	21
Akira Asakura, Mariko Kawamura, Mitsunobu Kamiya, and Takashi P. Satoh	
<b>4 Marine Plankton</b> . . . . .	35
Kazuo Inaba, Ken-ichiro Ishida, and Takeshi Nakayama	
<b>5 Marine Algae and Plants</b> . . . . .	49
Shigeki Wada, Ken-Ichiro Ishida, Michiyo Noda, and Hideki Abe	
<b>6 Marine Animals</b> . . . . .	65
Hiroaki Nakano	
<b>7 Distribution of Organisms on the Seashore</b> . . . . .	75
Koetsu Kon	

## Part II Cell and Developmental Biology

<b>8 Marine Organisms and Life Science</b> . . . . .	87
Kazuo Inaba	
<b>9 Gametes and Fertilization</b> . . . . .	93
Kazuo Inaba, Hitoshi Sawada, Manabu Yoshida, Kogiku Shiba, and Maki Shirae-Kurabayashi	
<b>10 Development of Marine Invertebrates</b> . . . . .	109
Shunsuke Yaguchi, Yoshiaki Morino, and Yasunori Sasakura	

<b>11</b>	<b>Development of Marine Fish: Several Procedures for the Observation of Embryonic Development . . . . .</b>	<b>125</b>
	Etsuro Yamaha, Rie Goto, Taiju Saito, Eisuke Takahashi, Takahiro Matsubara, and Katsutoshi Arai	
<b>12</b>	<b>Development of Marine Macroalgae . . . . .</b>	<b>149</b>
	Chikako Nagasato, Atsuko Tanaka, Kensuke Ichihara, and Taizo Motomura	
<b>13</b>	<b>Animal Larvae and Evolution . . . . .</b>	<b>163</b>
	Hiroaki Nakano	
 <b>Part III Marine Zoology</b>		
<b>14</b>	<b>Contribution of Marine Animals in Physiology, Endocrinology, and Ethology . . . . .</b>	<b>175</b>
	Kazuo Inaba	
<b>15</b>	<b>Physiology . . . . .</b>	<b>181</b>
	Chikako Shingyoji and Kenjiro Yoshimura	
<b>16</b>	<b>Endocrinology . . . . .</b>	<b>197</b>
	Yukitoshi Katayama, Takashi Kitahashi, Nobuo Suzuki, and Tatsuya Sakamoto	
<b>17</b>	<b>Animal Behavior . . . . .</b>	<b>205</b>
	Yasuhisa Henmi and Seiji Arakaki	
 <b>Part IV Marine Ecology</b>		
<b>18</b>	<b>Marine Ecology Introduction. . . . .</b>	<b>225</b>
	Jason M. Hall-Spencer	
<b>19</b>	<b>Marine Ecology: Temperate to Tropical . . . . .</b>	<b>231</b>
	Sylvain Agostini, Ben P. Harvey, and Shigeki Wada	
<b>20</b>	<b>Marine Ecology: Intertidal/Littoral Zone . . . . .</b>	<b>241</b>
	Koetsu Kon, Motohiro Shimanaga, and Masahiro Horinouchi	
<b>21</b>	<b>Marine Ecology: Continental Shelf to Deep Sea . . . . .</b>	<b>255</b>
	Yoshihiro Fujiwara and Koetsu Kon	
<b>22</b>	<b>Survey Techniques in Marine Ecology . . . . .</b>	<b>263</b>
	Ben P. Harvey, Koetsu Kon, and Sylvain Agostini	
<b>23</b>	<b>Experimental Design in Marine Ecology . . . . .</b>	<b>273</b>
	Koetsu Kon, Hideyuki Yamashiro, Masahiro Horinouchi, and Shun Kawaida	

---

**Part V Marine Environmental Science**

- 24 Marine Environmental Science Introduction** . . . . . 285  
Jason M. Hall-Spencer
- 25 Elemental Circulation** . . . . . 289  
Shigeki Wada
- 26 Human Impact** . . . . . 297  
Jason M. Hall-Spencer and Koetsu Kon
- 27 Survey Techniques in Marine Environmental Sciences** . . . . . 307  
Shigeki Wada and Yuko Omori
- 28 Experimental Design in Marine Environmental Sciences** . . . . . 315  
Sylvain Agostini, Ben P. Harvey, and Shigeki Wada

**Part VI Selected Topics in Marine Biology**

- 29 Marine Data** . . . . . 329  
Katsuhiko Tanaka and Kazuo Inaba
- 30 Biologging** . . . . . 335  
Katsufumi Sato
- 31 Marine Microbes** . . . . . 341  
Koji Hamasaki
- 32 Marine Conservation** . . . . . 347  
Abigail McQuatters-Gollop
- Index of Taxa** . . . . . 353
- Subject Index** . . . . . 359

---

## Editors and Contributors

---

### About the Editors

**Kazuo Inaba** holds a PhD from the Graduate School of Science, University of Tokyo (1990). He was an Assistant Professor at Misaki Marine Biological Station, University of Tokyo (1990–1998); Visiting Scientist, Worcester Foundation for Experimental Biology, Massachusetts, USA (1996); Visiting Associate Professor, National Institute for Basic Biology, Japan (2002–2003); Associate Professor, Asamushi Marine Biological Station, Tohoku University (1998–2004); Director (2005–2018), Shimoda Marine Research Center, University of Tsukuba, where he has been a Professor since 2004. He has been President of the Japanese Association of Marine Stations since 2009 and steering member of the World Association of Marine Stations since 2010. He was also a member of the editorial board of the Global Ocean Science Report, UNESCO-IOC (2016–2017). His research interests include cell motility and reproduction of marine invertebrates, fish, algae and other marine organisms; and structure, regulation, diversity and evolution of cilia and flagella.

**Jason M. Hall-Spencer** holds a PhD from Millport Marine Biological Station, University of London (1995). He had postdoctoral positions working all over Europe before becoming a Lecturer in Marine Biology, University of Glasgow in 2000. He moved a Royal Society University Research Fellowship (2003–2008) to the University of Plymouth, where he has been Professor of Marine Biology since 2012. He has been a Research Professor at the University of Tsukuba since 2016. He is a member of the Economics of Ocean Acidification working group (funded by the IAEA Monaco), a UK Government Scientific Advisor on Marine Protected Areas and a member of the ICES working group on deep water ecology. He served on the IPCC ocean acidification working group (2011–2012) and the ICES/OSPAR working group on Ocean Acidification 2013–2015 and was Chair of the NERC Facility for Scientific Diving Steering Committee 2014–2019. He is currently President of the British Phycological Society and is helping write the United Nations World Ocean Assessment II. His research interests include benthic ecology, CO<sub>2</sub> seeps, aquaculture, fisheries management and marine conservation.

## Contributors

**Hideki Abe** Hideki Abe Photo Office, Tokyo, Japan

**Sylvain Agostini** Shimoda Marine Research Center, University of Tsukuba, Shimoda, Shizuoka, Japan

**Katsutoshi Arai** Institute for the Advancement of Higher Education, Hokkaido University, Sapporo, Japan

**Seiji Arakaki** Amakusa Marine Biological Laboratory, Kyushu University, Fukuoka, Japan

**Akira Asakura** Seto Marine Biological Laboratory, Kyoto University, Kyoto, Japan

**Yoshihiro Fujiwara** Japan Agency for Marine-Earth Science and Technology (JAMSTEC), Yokosuka, Japan

**Rie Goto** South Ehime Fisheries Research Center, Ehime University, Matsuyama, Japan

**Jason M. Hall-Spencer** School of Biological and Marine Sciences, University of Plymouth, Plymouth, UK

Shimoda Marine Research Center, University of Tsukuba, Shimoda, Shizuoka, Japan

**Koji Hamasaki** Atmosphere and Ocean Research Institute, The University of Tokyo, Tokyo, Japan

**Ben P. Harvey** Shimoda Marine Research Center, University of Tsukuba, Shimoda, Shizuoka, Japan

**Yasuhisa Henmi** Center for Water Cycle Marine Environment and Disaster Management, Kumamoto University, Kumamoto, Japan

**Masahiro Horinouchi** Aquatic Ecology Division, Estuary Research Center, Shimane University, Matsue, Japan

**Kensuke Ichihara** Muroran Marine Station, Hokkaido University, Sapporo, Japan

**Kazuo Inaba** Shimoda Marine Research Center, University of Tsukuba, Shimoda, Shizuoka, Japan

**Ken-ichiro Ishida** Graduate School of Life and Environmental Sciences, University of Tsukuba, Tsukuba, Ibaraki, Japan

**Mitsunobu Kamiya** Tokyo University of Marine Science and Technology, Tokyo, Japan

**Yukitoshi Katayama** Atmosphere and Ocean Research Institute, The University of Tokyo, Tokyo, Japan

**Shun Kawaida** Aquatic Ecology Division, Estuary Research Center, Shimane University, Matsue, Japan

**Mariko Kawamura** Seto Marine Biological Laboratory, Kyoto University, Kyoto, Japan

**Takashi Kitahashi** Sado Marine Biological Station, Faculty of Science, Niigata University, Niigata, Japan

**Koetsu Kon** Shimoda Marine Research Center, University of Tsukuba, Shimoda, Shizuoka, Japan

**Takahiro Matsubara** South Ehime Fisheries Research Center, Ehime University, Matsuyama, Japan

**Abigail McQuatters-Gollop** Centre for Marine Conservation and Policy, University of Plymouth, Plymouth, UK

**Yoshiaki Morino** Graduate School of Life and Environmental Sciences, University of Tsukuba, Tsukuba, Ibaraki, Japan

**Taizo Motomura** Muroran Marine Station, Hokkaido University, Sapporo, Japan

**Chikako Nagasato** Muroran Marine Station, Hokkaido University, Sapporo, Japan

**Hiroaki Nakano** Shimoda Marine Research Center, University of Tsukuba, Shimoda, Shizuoka, Japan

**Takeshi Nakayama** Graduate School of Life and Environmental Sciences, University of Tsukuba, Tsukuba, Ibaraki, Japan

**Michiyo Noda** Kaiso Oshiba Kyokai (Pressed Seaweed Association), Tokyo, Japan

**Yuko Omori** Graduate School of Life and Environmental Sciences, University of Tsukuba, Tsukuba, Ibaraki, Japan

**Taiju Saito** South Ehime Fisheries Research Center, Ehime University, Matsuyama, Japan

**Tatsuya Sakamoto** Ushimado Marine Institute, Faculty of Science, Okayama University, Okayama, Japan

**Yasunori Sasakura** Shimoda Marine Research Center, University of Tsukuba, Shimoda, Shizuoka, Japan

**Takashi P. Satoh** The Kyoto University Museum, Kyoto, Japan

**Katsufumi Sato** Atmosphere and Ocean Research Institute, The University of Tokyo, Tokyo, Japan

**Hitoshi Sawada** Sugashima Marine Biological Laboratory, Nagoya University, Toba, Mie, Japan

**Kogiku Shiba** Shimoda Marine Research Center, University of Tsukuba, Shimoda, Shizuoka, Japan

**Motohiro Shimanaga** Center for Water Cycle Marine Environment and Disaster Management, Kumamoto University, Kumamoto, Japan

**Chikako Shingyoji** Department of Biological Sciences, Graduate School of Science, The University of Tokyo, Tokyo, Japan

**Maki Shirae-Kurabayashi** Sugashima Marine Biological Laboratory, Nagoya University, Toba, Mie, Japan

**Nobuo Suzuki** Noto Marine Laboratory, Kanazawa University, Kanazawa, Japan

**Eisuke Takahashi** Field Science Center for Northern Biosphere, Hokkaido University, Sapporo, Japan

**Atsuko Tanaka** Faculty of Science, University of the Ryukyus, Nishihara, Japan

**Katsuhiko Tanaka** School of Marine Science and Technology, Tokai University, Tokyo, Japan

**Shigeki Wada** Shimoda Marine Research Center, University of Tsukuba, Shimoda, Shizuoka, Japan

**Shunsuke Yaguchi** Shimoda Marine Research Center, University of Tsukuba, Shimoda, Shizuoka, Japan

**Etsuro Yamaha** Field Science Center for Northern Biosphere, Hokkaido University, Sapporo, Japan

**Hideyuki Yamashiro** Sesoko Station, Tropical Biosphere Research Center, University of the Ryukyus, Nishihara, Japan

**Manabu Yoshida** Misaki Marine Biological Station, University of Tokyo, Miura, Kanagawa, Japan

**Kenjiro Yoshimura** Department of Machinery and Control Systems, College of Systems Engineering and Science, Shibaura Institute of Technology, Tokyo, Japan

---

**Part I**

**Japanese Marine Flora and Fauna**





# Introduction to Marine Biology

# 1

Kazuo Inaba and Jason M. Hall-Spencer

## Abstract

Life on Earth began in the sea which covers 71% of our planet's surface and its algae have produced half of the atmospheric oxygen that we breathe. Under the influence of worldwide water currents, marine organisms are distributed as neuston, plankton, nekton, or benthos. This chapter summarizes the major horizontal and vertical gradients in chemical and physical conditions that determine ocean productivity of the sea which is driven by sunlight and algae. Seawater is a dense, viscous medium and so marine life has an array of adaptations to take advantage of this environment. We introduce the different marine phyla present, which have a far greater biodiversity than terrestrial fauna. This introduction explains the highly interdisciplinary nature of marine biology and demonstrates that pioneering research in the life sciences continues to use marine organisms, including evolutionary biology, molecular biology, developmental biology and physiology. The islands of Japan have attracted marine scientists worldwide due to an exceptional variety of conditions (from tropical corals to high latitude kelp forests, abyssal deep sea to shallow lagoons). This gives the region an unusually rich flora and fauna coupled by highly productive fisheries. This overview sets the scene for our book on Japanese marine life.

---

K. Inaba (✉)

Shimoda Marine Research Center, University of Tsukuba, Shimoda, Shizuoka, Japan  
e-mail: [kinaba@shimoda.tsukuba.ac.jp](mailto:kinaba@shimoda.tsukuba.ac.jp)

J. M. Hall-Spencer

Shimoda Marine Research Center, University of Tsukuba, Shimoda, Shizuoka, Japan  
School of Biological and Marine Sciences, University of Plymouth, Plymouth, UK

© Springer Nature Singapore Pte Ltd. 2020

K. Inaba, J. M. Hall-Spencer (eds.), *Japanese Marine Life*,  
[https://doi.org/10.1007/978-981-15-1326-8\\_1](https://doi.org/10.1007/978-981-15-1326-8_1)

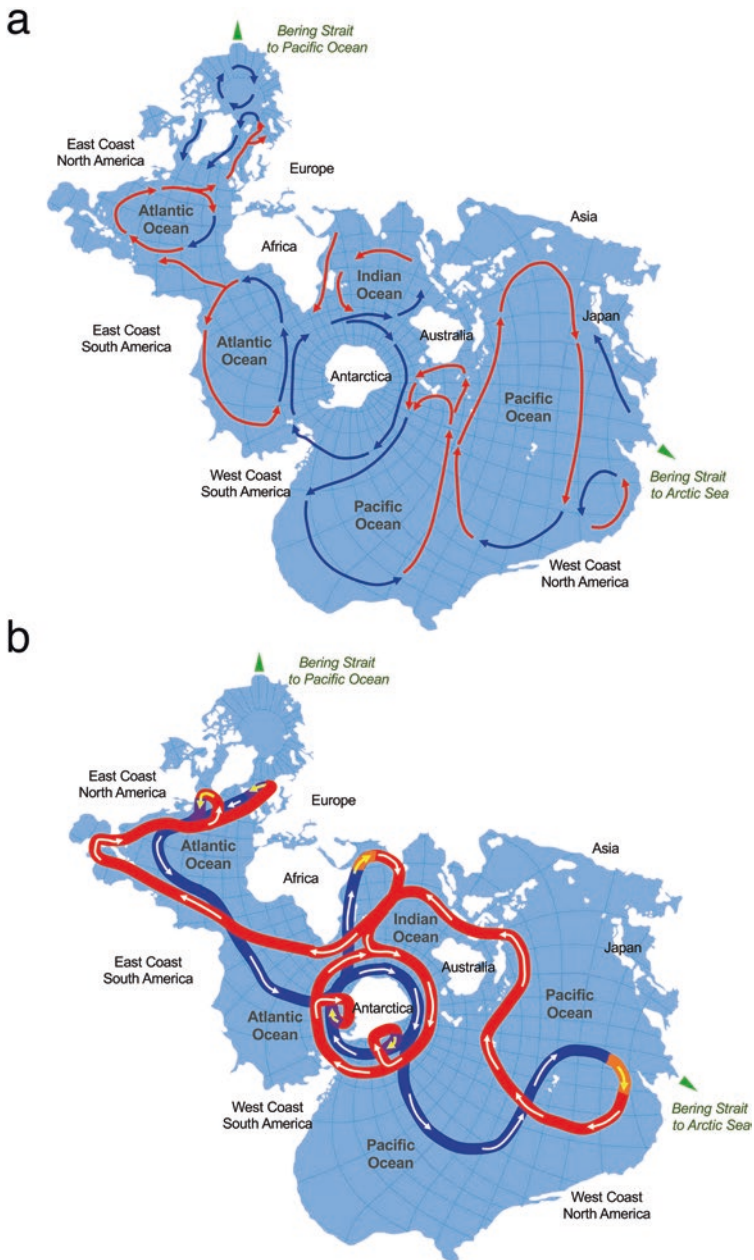
## 1.1 Ocean Interconnections

Fossils show that life evolved in the ocean 3 billion years before life on land, and so it is the cradle of life. Major early evolutionary radiations occurred in the ocean and this is reflected in the salty composition of animal body fluids. By convention, the world ocean is divided into the Pacific, Atlantic, Indian, Southern, and Arctic oceans in descending order of size, but these are all interconnected by water currents forming a system that is integral to life on Earth (Fig. 1.1). Seawater covers approximately 361,000,000 km<sup>2</sup>, which is 71% of our planet's surface. The ocean has a major influence on water and carbon cycles and it controls climate and weather patterns on land. It contains 97% of Earth's water and has produced half of the atmospheric oxygen that we breathe. With an average depth of nearly 3700 m the world ocean it is an immense habitat compared with land, forming 90% of the biosphere. Terrestrial life lives a few meters below the soil up to the tops of tree canopies. In comparison, marine life extends from just above sea level, in the splash zone on wave-swept coasts, to the bottom of the deepest trench ('Challenger deep', the 11.7 km deep Marianas Trench in the western Pacific Ocean). The surface of all the continents fit easily onto that of the Pacific Ocean with Japan situated to the northeast of this vast expanse. Under the influence of worldwide water currents, marine organisms are distributed as neuston, plankton, nekton, or benthos. The ocean has horizontal and vertical gradients in chemical and physical conditions (Fig. 1.2).

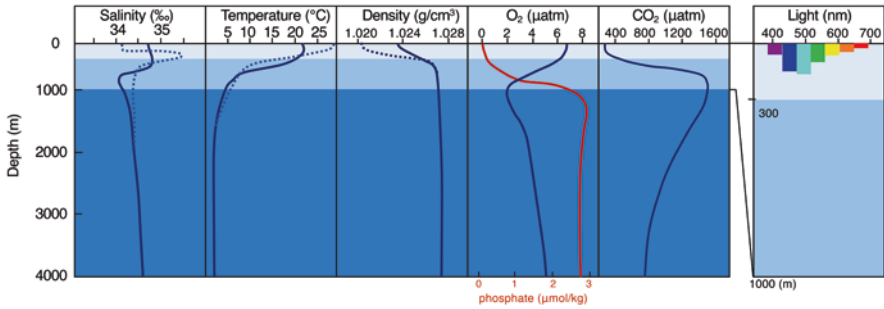
---

## 1.2 Ocean productivity

Comparing photosynthetic organisms in the sea versus those on land reveals key differences between these habitats. A giant kelp can grow as long as a Ginkgo tree even though it lacks supporting tissues. The kelp stays upright because it floats in a buoyant medium. The kelp needs to be able to flex since it grows in turbulent water. Trees have extensive roots whereas kelp thalli use short 'haptera' to fix themselves to rocks; they obtain the nutrients and water they need from the sea all around them. Unlike kelp, most marine flora is microscopic, such as coccolithophores, dinoflagellates, and diatoms. These freely drifting organisms live in the upper, sunlit layer of the ocean. Phytoplankton and photosynthetic bacteria are the ocean equivalents of terrestrial plants, forming the basis of virtually all marine food webs. In terrestrial habitats, net primary productivity is around 50 Gigatons of carbon each year with the standing stock of plant biomass of around 600 Gt C and a turnover time of around 15 years. Many land plants are long-lived and have a lot of structural carbohydrate (cellulose, lignin) that is not nutritious and breaks down slowly. In the sea, net primary productivity is also around 50 Gt C/year but the standing stock of algal biomass is only around 3 Gt C and the turnover time is around 0.03 years per generation since the vast majority of these organisms are short-lived microbes. Algal growth in the ocean supports >50% of animal production on the planet.



**Fig. 1.1** The world ocean is interconnected by currents. A, wind driven surface currents form circular gyres due to the Coriolis effect. Red arrows, warm currents; blue arrows, cold currents. B seawater density driven currents. Red, warmer shallow currents; blue, colder deep currents. A purple (two positions each at Atlantic and Antarctic Seas) and yellow parts (Indian and Pacific Oceans) represent areas of downwelling and upwelling, respectively



**Fig. 1.2** Typical physicochemical depth profiles of south Japan. Dashed or solid blue lines represent data at low (5°N) or high (30°N) latitude, respectively, along longitude 137°E. Red line represents phosphates (30°N, 137°E). Salinity and temperature are variable in surface water but become more stable below 1000 m depth. Seawater is densest below the thermocline. Nutrient levels (e.g., phosphate) are low in surface waters above the thermocline. Oxygen levels are lowest at around 600–1000 m depth where CO<sub>2</sub> levels peak. Blue wavelengths of light penetrate furthest, to > 200 m depth in the clearest waters, but beyond 1000 m depth the only light is from bioluminescence. Graphs are based on data from the Japan Meteorological Agency ([https://www.data.jma.go.jp/gmd/kaiyou/db/vessel\\_obs/data-report/html/ship/ship.php](https://www.data.jma.go.jp/gmd/kaiyou/db/vessel_obs/data-report/html/ship/ship.php))

### 1.3 Small and Large Life Forms in a Seawater World

Seawater is 850 times denser than air. Density is weight per unit volume; the denser a fluid the harder it is to sink, i.e. it provides more buoyancy. In the sea it is possible to float and move with little or no energy. Seawater is also 60 times as viscous as air. Viscosity describes how much force is needed to allow passage of an object through a fluid. This affects the sinking rate of objects; they fall through air 60 times faster than in seawater, so water slows the fall of particles to the seabed. The buoyancy and viscosity of seawater makes it possible to live life drifting in water column. Those organisms that drift are called plankton, such as diatoms and jellyfish. The nekton are organisms that swim actively, such as tuna and squid. The benthos live on the seabed but most of these organisms have a pelagic phase in their life history, taking advantage of the buoyant viscous medium of seawater.

Planktonic algae and animals, together with particulate and dissolved organic matter, provide a plentiful source of food. Many benthic animals stay still and have food brought to them by water movement; 98% of known marine species have a benthic stage with only 2% confined to the water column. ‘Aerial plankton’ provide a much thinner soup; the closest equivalent to suspension feeding on land is the capture of flying insects by web weaving spiders. In the sea there can be gardens of animals covering every centimeter of the seabed feeding on the waters passing over them. If you placed a bare panel into the sea in shaded conditions off Japan, then within 6 months it would be covered in sessile suspension feeding marine animals; an array of sponges, hydroids, and bryozoans. One very common feature of suspension feeders is a modular body architecture produced by budding. In this way connected individuals form colonies, for example, of corals or bryozoans.

Seawater is a supporting, non-desiccating fluid medium and so many marine algae and animals release sperm and eggs for external fertilization. This is often synchronized, so that at each year, at certain states of the moon and tide, a coral reef can appear to be shrouded by millions of spores floating in the water column. Many organisms, from seaweeds to echinoderms, make use of this broadcast spawning strategy.

In any moving fluid, viscous forces and inertial forces compete. An organism in seawater is subject to viscous forces that act to make the object move with the water, or stop if the water is stationary. Inertia is the tendency of a moving object to keep on moving, like a snooker ball across the table. Inertial forces will thus act to make an object continue moving in still water. Reynolds number ( $Re$ ) describes the relative importance of viscous and inertial forces in a given set of circumstances.

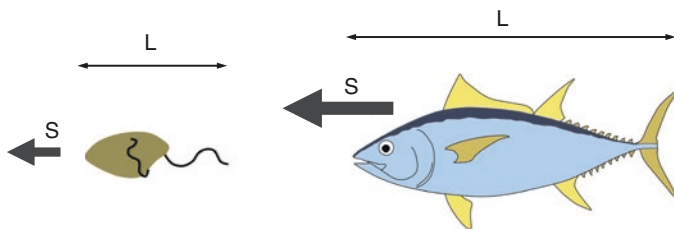
$$Re = SLD / V$$

Length ( $L$ ) and speed ( $S$ ) of the object; density ( $D$ ) and viscosity ( $V$ ) of the fluid [ $D = 1.02 \text{ kg/m}^3$ ,  $V = 1.05 \times 10^{-6} \text{ m}^2 \text{ s}^{-1}$  (salinity 35; 20 °C)]

An organism that is large and fast (e.g. a tuna) will have a high  $Re$ . Something that is small and slow (e.g. phytoplankton or a sperm cell) will have a low  $Re$ . A 1  $\mu\text{m}$  diameter phytoplankton cell swimming at 30  $\mu\text{m s}^{-1}$  will stop dead in  $10^{-4} \mu\text{m}$ , 0.6  $\mu\text{s}$  if it ceases swimming. The absolute speed of smaller organisms is low but their relative speed can be high. A protozoan may swim up to 100 body lengths per second, whereas a tuna swims up to 10 body lengths per second (Fig. 1.3).

## 1.4 Variety of Marine Organisms

Taxonomy is the classification of organisms based on morphological and functional characteristics, genetic traits, and other criteria. At the level of different body plans, termed phyla, marine animals have a far greater biodiversity than terrestrial fauna. Fifteen phyla are restricted to the oceans such as the comb jellies, brachiopods, and echinoderms. Only one phylum restricted to land, the Onychophora, and fossils of these ‘velvet worms’ from the Middle Cambrian show they once lived in the sea. Most of those phyla that occur in the oceans and on land are aquatic and these include sponges and bryozoans. Within the Mollusca,



**Fig. 1.3** Hydrodynamic effect of ocean water on the locomotion of microorganisms (dinoflagellate) vs nekton (fish)

gastropods and bivalves are common in marine habitats and some have evolved to cope with life on land or in freshwater, but the other major classes of mollusc (Aplacophora, Polyplacophora, Cephalopoda, and Scaphopoda) are restricted to seawater. Only three animal groups, below phylum level, have crossed from aquatic habitats and become characteristic of land: uniramian and chelicerate arthropods, and tetrapod chordates (including man). So, if you are interested in life on Earth, marine biology is the topic for you! The common names of selected marine organisms are shown in Fig. 1.4.

---

## 1.5 Marine Organisms as Key Players in Life Science

Life began in the sea from the generation of small organic molecules, then macromolecules. Subsequent formation of self-replicable molecules, including deoxyribonucleic acid (DNA), and their compartmentation within a lipid bilayer (membrane) gave rise to cells. Symbiosis accelerated the evolution of eukaryotes from prokaryotes. As well as the diversification of unicellular cells, several organisms with distinct body plans were generated as organisms became multicellular. Thus, several life forms that originated in the sea have handed down common molecular and cellular mechanisms. Pioneering research in life sciences has been conducted using marine organisms in evolutionary biology, molecular biology, developmental biology and physiology. Prominent examples include the Nobel Prize-winning work of Andrew Huxley and Alan Hodgkin who discovered the mechanism of membrane excitability using the squid *Loligo forbesii* which has a giant axon. Their work revealed how cells communicate with each other and how signals are sent along nerves. Nobel prize-winning work of Eric Kandel elucidated the mechanisms of memory formation using the sea slug *Aplysia californica*.

Many marine invertebrates produce gametes. Insemination of eggs by sperm triggers fertilization and subsequent mitosis. Cyclin is a family of proteins that are key to cell cleavage and the development of organisms. They were first found in sea urchins by Nobel prize-winning R. Timothy Hunt in his observations of sea urchin development. Some marine organisms synthesize a variety of unique compounds that have biomedical applications. Some can block specific ion channels or enzymes, which are a useful tool for research. Nobel prize-winning Osamu Shimomura isolated green fluorescent protein from the jellyfish *Aequorea victoria* and this is now widely used for molecular labeling. Beside these, marine organisms have helped scientists reveal the mechanisms of fertilization, endocrinology, and animal behavior.

---

## 1.6 High Diversity of Marine Flora and Fauna Around Japan

Japan is an island nation with several distinct climate regimes. It is surrounded by the North Pacific Ocean, the Japan Sea, the Sea of Okhotsk, and the East China Sea. Japan is intersected by four tectonic plates: the Eurasian plate, the North American


































PHYLUM	COMMON NAME		PHYLUM	COMMON NAME	
<b>Porifera</b>	sponge		<b>Annelida</b>	ragworm	
<b>Cnidaria</b>	jellyfish			feather-duster worm	
	sea anemone			tube worm	
	coral		<b>Mollusca</b>	chiton	
<b>Ctenophora</b>	comb jelly			limpet	
<b>Platyhelminthes</b>	flatworm			sea slug	
<b>Nemertea</b>	ribbon worm			abalone	
<b>Rotifera</b>	rotifer			cone shell	
<b>Bryozoa</b>	bryozoa (moss animals)			cowry	
				moon snail	
<b>Phoronida</b>	horseshoe worm			top shell	
<b>Brachiopoda</b>	lamp shell			mussel	
	lingula			clam	
				razor clam	
				giant clam	
<b>Sipuncula</b>	peanut worm			oyster	
<b>Echiura</b>	spoon worm			scallop	
<b>Chaetognatha</b>	arrow worm			squid	

Fig. 1.4 Major marine organisms with phyla and common names





































PHYLUM	COMMON NAME		PHYLUM	COMMON NAME	
<b>Mollusca</b>	cuttlefish			sand dollar	
	octopus			starfish	
<b>Nematoda</b>	round worm			brittle star	
<b>Arthropoda</b>	horseshoe crab			sea cucumber	
	sea slater		<b>Hemichordata</b>	acorn worm	
	barnacle		<b>Chordata</b>	sea squirt (tunicate)	
	gooseneck barnacle			colonial ascidian (tunicate)	
	ostracods			salp (tunicate)	
	copepod			lancelet (amphioxus)	
	mantis shrimp			hagfish	
	amphipods			lamprey	
	krill			ray	
	crab			skate	
	shrimp			tiger shark	
	prawn			great white shark	
	lobster			shortfin mako shark	
<b>Echinodermata</b>	feather star			hammerhead shark	
	sea urchin			whale shark	

Fig. 1.4 (continued)









































PHYLUM	COMMON NAME		PHYLUM	COMMON NAME
<b>Chordata</b>	banded dogfish		sillago	
	bullhead shark		grunt	
	angelshark		goby	
	swell shark		sea bream	
	moray		sea bass	
	conger eel		tuna	
	herring		bonito	
	sardine		mackerel	
	salmon		horse mackerel	
	cod		hairtail	
	monkfish		yellowtail	
	angler fish		flounder	
	mullet		sole	
	barracuda		tonguefish	
	pacific saury		filefish	
	seahorse		puffer fish	
	rockfish		sea snake	
	stonefish		sea turtle	
	alfonsino		common tern	

Fig. 1.4 (continued)
























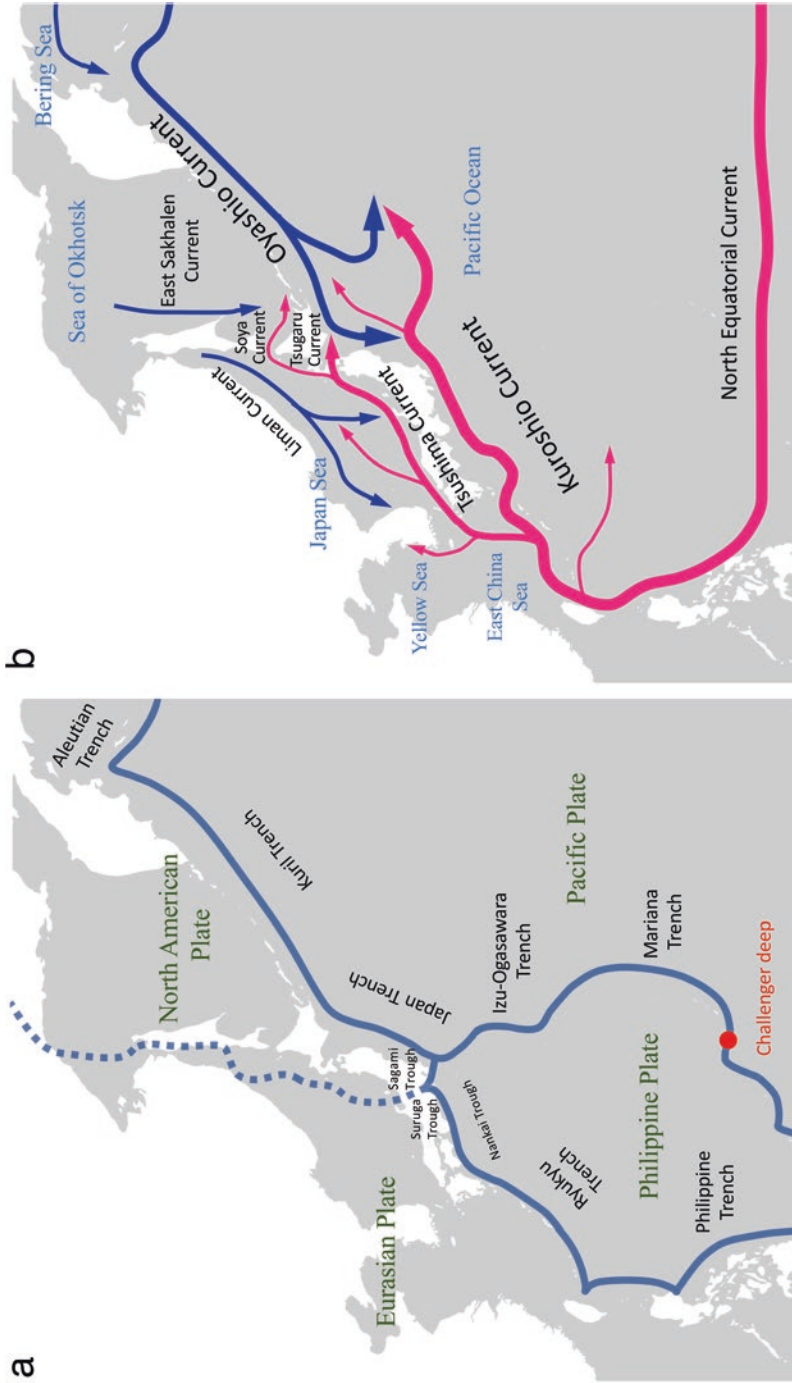
PHYLUM	COMMON NAME	Marine algae and plants		
Chordata	seagull (common gull)		brown algae	
	black-tailed gull		kelp	
	auklet		red algae	
	rock thrush		coralline algae	
	cormorant		green algae	
	sperm whale		seagrass (eelgrass)	
	humpback whale			
	beaked whale			
	killer whale			
	spinner dolphin			
	bottlenose dolphin			
	Dall's porpoise			
	white-sided dolphin			
	sea lion			
	seal			
	sea otter			
	walrus			

Fig. 1.4 (continued)



**Fig. 1.5** Ocean plates (a) and major ocean currents (b) around Japan. Pink and blue lines represent warm and cold currents, respectively, in (b)

plate, the Pacific plate, and the Philippine plate (Fig. 1.5a). This tectonic activity is responsible for a number of significant seabed features, including submarine volcanoes, multiple trenches, and troughs as well as a wide depth range.

The Pacific side of Japan is affected by the warm Kuroshio (Japan Current) that flows north, and the cold Oyashio which flows south. The Tsushima Current passes through the Japan Sea from north to south and another two warm currents are present in the northern regions, the Tsugaru Current and the Soya Current, flowing to the east (Fig. 1.5b). This variety of conditions gives Japan an enormously rich flora and fauna. The currents bring nutrients up from the deep and strong mixing by rip tides provides highly productive fisheries (e.g., the Sanriku area off the Tohoku coast).

The marine environment provides approximately 300 times more space than that provided by land and freshwater combined. The water column is divided into three layers: surface, intermediate, and deep layers. The surface water is affected by the air temperature, latitude, seasons, wind, rain, waves, and currents and tends to be low in nutrients. The main thermocline lies in the intermediate layer and below this is an oxygen minimum zone. Below 1000 m depth, physicochemical properties, including salinity, temperature, density, and the concentrations of oxygen, CO<sub>2</sub>, and nutrients are almost constant. Japan is surrounded by several trenches and troughs that are close to the coast, the Japan Trench, Izu-Ogasawara Trench, Ryukyu Trench, Nankai Trough (including Sagami and Suruga trenches), providing rich fauna and flora (Fujikura et al. 2010).

---

## 1.7 Marine Biology in Japan

Marine biology in Europe got off to an early start thanks to the description of marine species collected during large scale expeditions, such as those by Christopher Columbus (1492), James Cook (1768–1771) and aboard HMS Beagle (1831–1836) and HMS Challenger (1872–1876). Marine biology took off as a science somewhat later in Japan although the richness of marine organisms around these shores was reported by many visiting scientists, including E. Kaempfer (1690s), P.F.B. von Siebold (1820s), F.M. Hilgendorf, E.S. Morse, and L.H.P. Döderlein (1870s). In Europe, the earliest marine stations included Concarneau (1859), Roscoff and Naples (1872), Kristineberg (1877), Villefranche-sur-mer (1880), and Plymouth (1884). The first Japanese marine station was founded by Tokyo Imperial University at Misaki, Kanagawa prefecture in 1886. Thereafter, many marine stations were built so there are now approximately 50 marine stations located from Hokkaido in the north to Okinawa in the south (Inaba 2015). Many important marine biological research studies have been conducted at these facilities. These include, for example, discovery of the acrosome reaction (Jean Clark Dan), identification of microtubules in cells (Hideo Mohri), mechanical properties of mitotic apparatus (Katsuma Dan, Yukio Hiramoto), hormonal regulation of oocyte maturation (Haruo Kanatani), introduction of stable isotopes in the analysis of food webs (Eitaro Wada), description of marine snow (Hokkaido University group), and the exploration of spawning areas and behavior of Japanese eel (Katsumi Tsukamoto). There are now around

800 marine stations in the world (Isensee et al. 2017). They play an important part in the research of marine biology and greatly contribute to education and field science for University students and the general public, from children to adults.

---

## 1.8 How to Study Marine Biology

As you will find in this book, marine biology is interdisciplinary. We have roughly divided it into studies of individual organisms and studies at the ecosystem level. The former involves understanding marine organisms at the molecular or cell level. Studies on the mechanisms of reproduction, development, neural activity, behavior, and evolution are the basis for understanding how marine organisms form ecosystems. Some marine biologists focus on the biochemistry of certain marine organisms which underpins communication, predation, and defense. Studies at the ecosystem level involves working out how organisms interact, including reproduction, habitat provision and selection, food web dynamics, population, environmental influences, oceanography studies of human impacts. In all these cases field sampling and observations are the basis of marine biology and as editors we will be delighted if this book helps you to come to realize that marine biology is a wonderful academic area.

---

## References

- Fujikura, K., Lindsay, D., Kitazato, H., Nishida, S., & Shirayama, Y. (2010). Marine biodiversity in Japanese waters. *PLoS One*, 5, e11836.
- Inaba, K. (2015). Japanese marine biological stations: Preface to the special issue. *Regional Studies in Marine Sciences*, 2, 154–157.
- Isensee, K., Pae, S., Horn, L., Inaba, K., Schaaper, M., & Valdes, L. (2017). Research capacity and infrastructure. *Global Ocean Science Report: the current status of ocean science around the world*, UNESCO publishing.



Kazuo Inaba

## Abstract

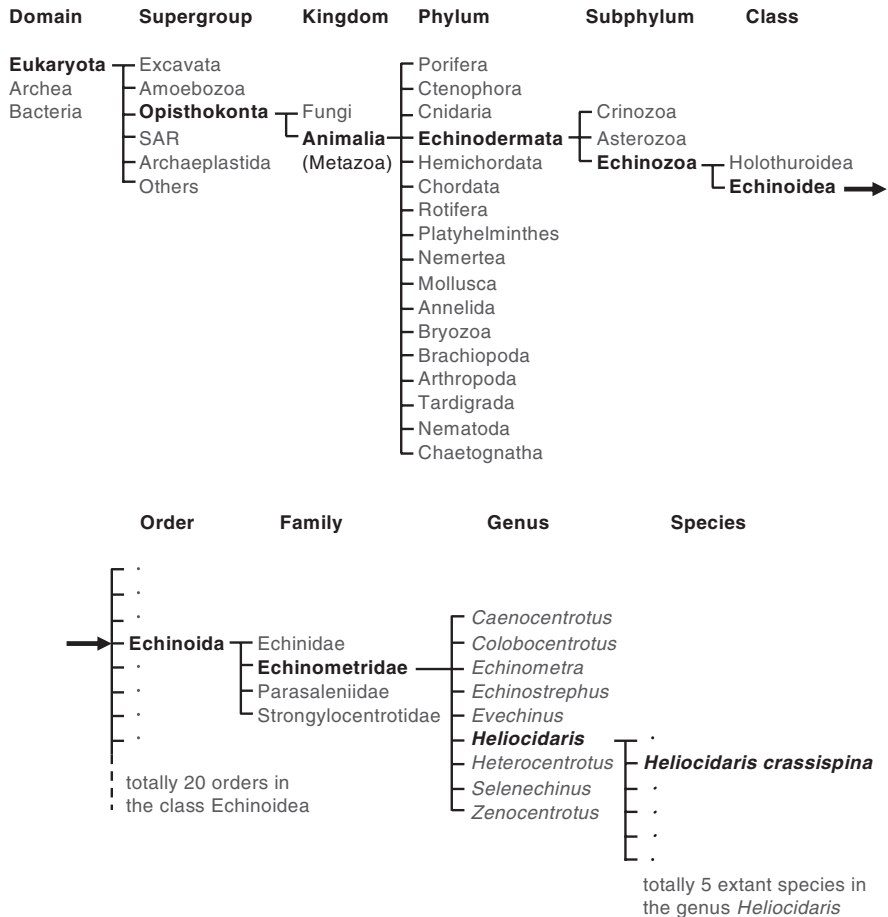
Life on this planet was born in the ocean, and then evolved and spread throughout the aquatic areas. Marine life has now colonized all of the ocean, such as coastal (littoral) and open ocean; pelagic (photic and aphotic) and benthic; shallow (neritic) and deep seas. Fauna refers to animals, and flora refers to plants and algae. Other forms of life, such as protists, fungi, and bacteria, are also important members of marine communities. The minimal unit of biological classification or taxonomy is a ‘species’, which is a group with morphological and genetical similarity and reproduces with one another. Modern taxonomy was founded by Carl Linnaeus, who established the binary (binomial) nomenclature for a species (genus name + specific name), which is still used today.

Although the number of species identified in the ocean is approximately 200,000, it is estimated to be ~2.2 million when including the unidentified ones. Most of these species (~95%) in the ocean have not been identified. For a phylogenetic point of view first presented by Charles Darwin, each species is grouped into higher taxonomic ranks in the tree of life, i.e., genus, family, order, class, phylum, kingdom, and domain, which make up a hierarchy (Fig. 2.1). The highest rank of the hierarchy is the domain, which consists of Archaea, Bacteria, and Eukarya. Two domains, Archaea and Bacteria, are prokaryotes, which lack membranous organelles, such as nucleus, mitochondria, and chloroplasts. Archaea are generally similar to bacteria in size and shape. However, their genes and several metabolic pathways are more

---

K. Inaba (✉)

Shimoda Marine Research Center, University of Tsukuba, Shimoda, Shizuoka, Japan  
e-mail: [kinaba@shimoda.tsukuba.ac.jp](mailto:kinaba@shimoda.tsukuba.ac.jp)



**Fig. 2.1** Biological taxonomy. An example for the sea urchin commonly seen in Japanese marine coast, *Heliocidaris crassispina*, is used to demonstrate taxonomic ranks (also see Chap. 3)

closely related to those of eukaryotes, from which they are clearly separated from bacteria. Eukaryotes are thought to have arisen by symbiosis of one archaeon and one or several bacteria. They achieved multicellularity, which resulted in the formation of multiple tissues and organs with specific functions.

The five-kingdom system was proposed by Robert Whittaker (1969) and has become well established. This divides organisms into four kingdoms in Eukarya (Animalia, Plantae and Fungi and Protista) and a kingdom Monera (Archaea and Bacteria). Animals and plants are typically the most familiar terms, allowing a convenient and widespread way to group life forms (Chap. 3). Animals tend to demonstrate active movement and are dependent on the consumption of

organic matter (heterotrophy), whereas plants tend to be static and produce organic matter via photosynthesis (autotrophy). This definition is now generally applied to multicellular organisms. Marine animals (Chap. 6) include several phyla, including many types of invertebrates that are only present in the oceans. The phylogenetic positions of some animal phyla are still under debate. Marine plants, including marine algae, seagrasses, marsh grass, and mangroves, are not only important for producing oxygen and being a food source for animals but also in providing substrata for sessile species and shelter for marine animals, particularly their larvae (Chap. 5). Unicellular organisms are grouped into Protista, some of which show properties of both animals and plants (e.g., dinoflagellates are mostly motile and around half are capable of photosynthesis). Unicellular organisms that actively move were once called Protozoa (-zoa for animals), although this term is now rarely used. Fungi represent a different group of organisms, since they demonstrate heterotrophy (no photosynthesis), as well as a synthesis of chitin and cell walls. Viruses are one of the final groups of life forms where their proliferation is completely dependent on the cells of a host. Viruses, bacteria, and archaea represent a large part of ocean biomass, much larger than that of eukaryotes, and play important roles in element circulation as decomposers within one of the essential parts of the ocean food web, the microbial loop (see Chap. 31).

Recent progress in electron microscopic observation of cellular structures and a large-scale effort into molecular phylogenetic analysis revealed some problems in the classification of organisms into the five kingdoms, particularly for Eukarya. The eukaryotes (Eukarya) and prokaryotes (Archaea and Bacteria) are clearly separated by their cellular structures and the molecules used in their cellular activity. Several hypotheses have been proposed for the evolution of eukaryotes but recently an alternative system has been proposed to divide the eukaryotes into five 'supergroups', i.e., Excavata, Amoebozoa, Opisthokonta, Stramenopiles+Alveolata+Rhizaria (SAR), and Archaeplastida, along with a few other groups. This premise is relatively well accepted, although no established system exists yet for describing the phylogeny. As plankton contain organism groups that are widely spread among these supergroups, they represent one of the best targets for investigating the diversity of eukaryotes (Chap. 4).

Marine organisms are distributed in a variety of habitats, forming unique ecological zones (Chap. 7). Marine organisms often share common morphological and functional properties, such as unique structures enabling attachment to the substratum in sessile species and tubes, siphons or tentacles in infaunal benthos, but these organisms are not always phylogenetically related. During their life cycles, many organisms will change their habitats, e.g., moving from planktonic to benthic (sessile, epifaunal, or infaunal). This has important implications for their growth and dispersion, as well as the marine food web.

In marine biology, one of the most basic experiences simply involves the collection, observation, and investigation by sight of different marine organisms. During the process of collection, you can learn about the role of different marine organisms in their habitats, and how they interact. During observation, you will learn the differences



---

among them in terms of their shape and internal structures. To identify species, we typically use identification guidebooks that are available in Japan (Japanese version) or outside Japan (English version). Several on-line databases for marine organisms are now available. The number of organisms with genomic information is increasing, which makes it possible to carry out phylogenetic studies and other molecular analyses (Chap. 29). Chapters 3 to 7 aim to enable a basic understanding of marine organisms, as well as an indication of their diversity. You will hopefully narrow down the species that you want to identify using this book but will need to refer to other identification guide books or on-line information for confirmation.

---

## Reference

Whittaker, R. H. (1969). New concepts of kingdoms or organisms. Evolutionary relations are better represented by new classifications than by the traditional two kingdoms. *Science*, 163, 150–160.



# Basic Taxonomy of Marine Organisms

# 3

Akira Asakura, Mariko Kawamura, Mitsunobu Kamiya,  
and Takashi P. Satoh

## Abstract

The diversity of marine organisms in Japanese water is very high with 33,629 species reported, but there are still an estimate 122,000 undescribed species. In this chapter, we introduce major taxa found in intertidal and shallow waters in Japan for this practical training guide for students and teachers, with basic information on their morphology and ecology. Unicellular organisms are a polyphyletic group in the Domains Bacteria and Eukaryota, and here we provide a brief introduction to Cyanobacteria, Dinoflagellata, Ciliata, Radiolaria, Foraminifera, and Diatomea. Similarly, we deal with Phaeophyceae (brown algae), Rhodophyta (red algae), and Ulvophyceae (green algae) and seagrasses (some members of Alismatales). Furthermore, we provide a brief introduction to marine animals including Porifera, Cnidaria, Ctenophora, Rotifera, Platyhelminthes, Nemertea, Mollusca, Annelida, Bryozoa, Brachiopoda, Arthropoda, Tardigrada, Nematoda, Chaetognatha, Echinodermata, Hemichordata, and Chordata. Illustrations of representatives of each group of organisms are also given.

---

A. Asakura (✉) · M. Kawamura  
Seto Marine Biological Laboratory, Kyoto University, Kyoto, Japan  
e-mail: [asakura.akira.6w@kyoto-u.ac.jp](mailto:asakura.akira.6w@kyoto-u.ac.jp)

M. Kamiya  
Tokyo University of Marine Science and Technology, Tokyo, Japan

T. P. Satoh  
The Kyoto University Museum, Kyoto, Japan

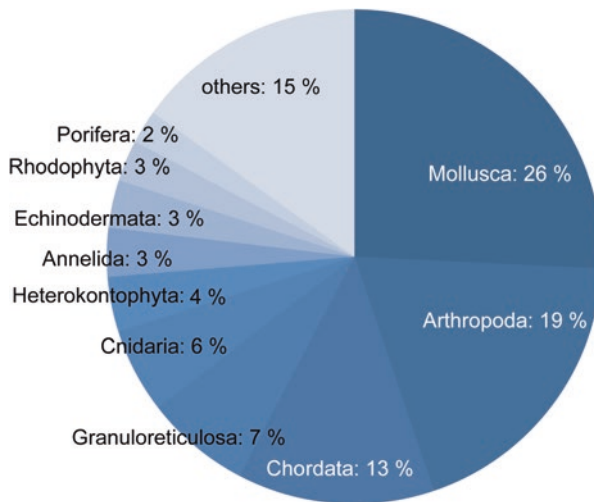
### 3.1 Overview

Organisms are divided into three broad categories called domains; Bacteria, Archaea, and Eukaryota. Bacteria and Archaea are prokaryotes, i.e., single-celled organisms that lack a nucleus. The Eukaryota have cells with a nucleus and membrane-bound organelles, and many multicellular organisms are included. Living organisms are classified into domain, kingdom, phylum, class, order, family, genus, and species. These can be split by the prefix sub- (e.g., subclass, suborder, subfamily) or clumped by the prefix super- (e.g., superclass, superfamily). The species follow a binomial nomenclature, with species names composed of two parts, the genus and the specific epithet.

For example, a common intertidal crab *Hemigrapsus takanoi* Asakura and Watanabe 2005 placed as in; Kingdom Animalia: Phylum Arthropoda: Subphylum Crustacea: Class Malacostraca: Subclass Eumalacostraca: Superorder Eucarida: Order Decapoda: Suborder Pleocyemata: Infraorder Brachyura: Superfamily Grapsoidea: Family Varunidae: Genus *Hemigrapsus*: Species *Hemigrapsus takanoi*.

Organisms in all domains live in the sea, and 79 phyla are found in the sea around Japan (Fujikura et al. 2010). A total of 33,629 species are reported in Japanese waters, with an estimated 121,913 undescribed species bringing the total to 155,542 marine species around Japan (Fujikura et al. 2010). Among the species named on inventories, molluscs, arthropods, and chordates are dominant although this grossly underestimates some groups such as the Annelida (Fig. 3.1).

In intertidal and shallow waters in Japan, species diversity is generally high because of a combination of various historical and environmental (geological and



**Fig. 3.1** Percent ratio of the number of described species in each phylum per total number of described species in all phyla ranked from 1st to 10th (Fujikura et al. 2010)

physical oceanographic) factors. In this chapter, we introduce major taxa found. For further reading, see Graham and Wilcox (2000), Lee (2018), Nelson et al. (2016).

---

## 3.2 Unicellular Organisms

Unicellular organisms are a polyphyletic group in the Domains Bacteria and Eukaryota. Bacteria comprise a small prokaryotic cell (<10  $\mu\text{m}$ ) without organelles surrounded by a membrane. Unicellular eukaryotes have larger cells with organelles such as a nucleus, mitochondria, chloroplasts (in case of photosynthetic organisms). Marine unicellular organisms in Japanese coastal waters mainly include the prokaryotic Cyanobacteria and six eukaryotic groups: Diatomea (class in phylum Ochrophyta), phylum Dinoflagellata, phylum Ciliata, phylum Foraminifera, and phylum Radiolaria. They usually reproduce asexually, but sometimes sexually.

**Cyanobacteria** (also called blue-green algae) are photosynthetic and have unicellular, filamentous, or colonial forms. They produce oxygen as a by-product of photosynthesis and lack typical eukaryotic flagella and organelles. Many species can fix atmospheric nitrogen within specialized cells called heterocysts. They are common in both the sea and freshwater, and some species are symbiotic with animals, fungi, plants, and other eukaryotic algae. Sexual reproduction of the typical eukaryotic type, involving gamete fusion, is not found.

**Dinoflagellata** (Dinophyta, dinoflagellates) is a large group of Alveolata, mostly unicellular flagellates having two dissimilar flagella. About half of the dinoflagellate species are colorless heterotrophs, and the rest possess plastids that vary significantly in pigment composition, suggesting that their chloroplasts were incorporated by several endosymbiotic events. Cell covering is a peripheral layer of membrane-bound vesicles, which in many cases enclose cellulose plates. Symbiotic dinoflagellates known as zooxanthellae occur in reef-forming corals and other marine invertebrates. The vast majority are marine, and sexual reproduction is known.

**Ciliata** (ciliates) have a flexible body with many hair-like locomotor organelles (cilia) and have two kinds of nuclei: macronucleus and micronucleus. Some planktonic species secrete a chitinous outer skeleton. Most species ingest microalgae; and some (e.g., *Mesodinium* spp.) can photosynthesize using chloroplasts from ingested algae.

**Radiolaria** (radiolarians) have an amoeba-like body, most being supported by a siliceous skeleton with radial spines. They use the pseudopodia (supported by

microtubules) to capture prey. All are planktonic and they sometimes form deep sea sediments known as oozes.

**Foraminifera** (forams) have an amoeba-like body although most are enclosed within a porous calcareous shell. They crawl and catch prey with long filiform pseudopodia. Most species are benthic but some planktonic species are abundant and like radiolarians they can form sediment deposits in the deep sea known as oozes.

**Diatomea** (Bacillariophyta, diatoms) are Ochrophytes with cells encased in a silica cell wall (hydrated silicon dioxide). They are divided radially symmetric (centric diatoms) and bilaterally symmetric (pennate diatoms), and their myriad variations in delicate ornamentation reflect their wide taxonomic diversity with more than 15,000 species described so far. During vegetative cell division, most diatoms get gradually smaller with every division, and these cells regain their original size by the formation of a special large cell, called an auxospore, through sexual reproduction.

---

### 3.3 Macroalgae and Seagrasses

#### Chromista

*Ochrophyta* (*Heterokontophyta*)

*Phaeophyceae* (brown algae) are multicellular algae, varying in form from filamentous, crustose, leafy, sac shaped, or branched. Some large species have gas-filled bladders (pneumatocysts), which keep the thallus floating on or near the surface of the water for photosynthesis. Brown algae contain an accessory pigment, fucoxanthin, in the chloroplasts, giving them a brown color. The vast majority live in marine environments. Many species have a haploid gametophyte and diploid sporophyte, and their sexual reproduction is performed by gametogamy or oogamy.

#### Plantae

*Rhodophyta* (red algae) can be small unicellular organisms or form simple filaments, crusts, flexible blades, or complex filament aggregations. Thallus color varies depending on the ratio of chlorophyll *a* and the accessory photosynthetic pigments phycobilins and carotenoids, while a few parasitic species are colorless. Calcified red algae known as corallines are widespread and form what looks like pink paint in rockpools. More than 95% of the red algae are marine. Sexual reproduction is oogamous and male gametes lack flagella. Most species have a haploid gametophyte that is the same or larger than the diploid sporophyte.

*Chlorophyta*

*Ulvophyceae* (green algae) are Chlorophyta characterized by having chlorophyll *a* as well as chlorophyll *b* and starch in their plastids. Most species are multicellular forming uninucleate sheets (e.g., *Ulva* spp.), an umbrella (e.g., *Acetabularia* spp.),

multinucleate filaments (e.g., *Cladophora* spp.), or siphons (e.g., *Bryopsis* spp.). Most occur in marine environments and have haploid gametophyte and diploid sporophyte. Sexual reproduction is performed by gametogamy (in which gametes fuse)

*Seagrasses* are monocotyledonous flowering plants, classified into seven families (Zosteraceae, Cymodoceaceae, Posidoniaceae, Zannichelliaceae, Potamogetonaceae, Ruppiaceae, and Hydrocharitaceae), all in the order Alismatales. Their leaves lack stomata, most have adhesive filamentous pollen (except for Hydrocharitaceae) and their seeds do not have large energy reserves. Horizontal stems (called rhizomes) often spread under the sediment and send up new shoots (Fig. 3.2).

---

### 3.4 Animals (Metazoa)

#### Non-Bilateria

*Porifera* (sponges) are basal Metazoa with a cellular basis of construction without true tissues and organ and no body symmetry. Sponges pump water into their body through inhalant pores known as ostia, and the water flows through a large central cavity (= spongocoel), where specialized collar cells (choanocytes) filter out food particles, and the filtered water is then passed out through pores known as oscula. Their endoskeleton consists of silica or calcareous rods called spicules. Sponges reproduce asexually (by budding or gemmules) or sexually. Most sponges are hermaphrodites. Embryos develop into planktonic larvae with short pelagic periods; coeloblastula (blastula, amphiblastula) or parenchymula (parenchymella, stereogastrula).

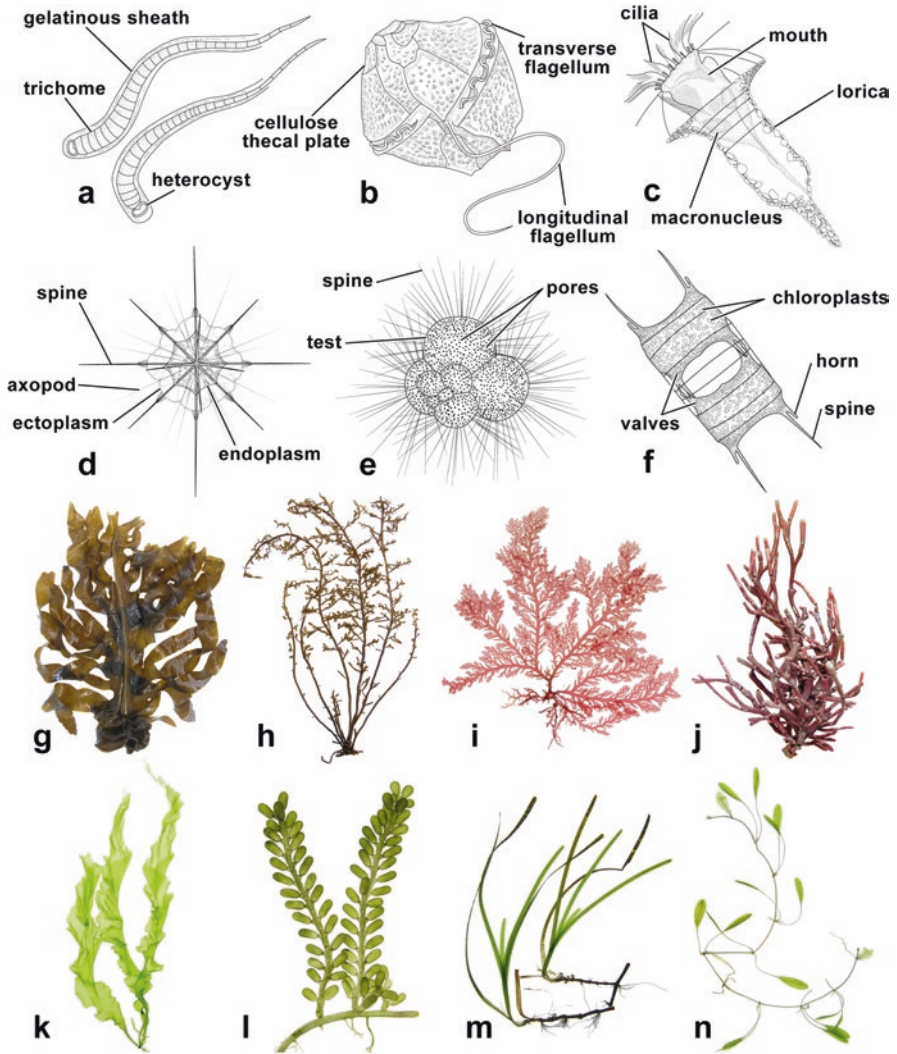
*Cnidaria* (sea anemones, hydroids, corals, and jellyfishes) have radial symmetrical body with a mouth, tentacles, and no anus. The tentacles have stinging cells (cnidocytes) to catch prey. Digested prey are carried through gastrovascular canals. Sea anemones and corals only have a benthic polyp stage, whereas most jellyfishes and hydroids also have planktonic medusa stage. The polyps can develop internal septa, corals and hydroids secrete an exoskeleton for attachment and support; medusae can develop eyes and statocysts to swim. The cnidarians are dioecious (partly hermaphroditic) and produce planula larvae, a ciliated and free-swimming larval form.

*Ctenophora* (comb jellies) have biradial symmetry with a mouth and two anal pores and apical sense organ. Planktonic species use eight rows of ciliary plates (comb plates) to swim; these comb plates are reduced in some benthic species. Most species have two tentacles with many lateral branches (tentilla) equipped with adhesive cells (colloblasts) to catch prey. Digested prey are carried through gastrovascular canals. They are hermaphroditic and produce cydippid larvae.

#### Bilateria: Protostomia

##### *Spiralia* (*Lophotrochozoa*)

*Rotifera* (rotifers) are microscopic body with a ciliated organ (corona) around head. The soft body is enclosed by chitinous lamina. A modified pharynx (the



**Fig. 3.2** Unicellular organisms, macroalgae, and seagrasses, (a) blue-green alga (*Calothrix* sp.); (b) dinoflagellate (*Gonyaulax* sp.); (c) ciliate (*Eutintinnus lususundae*); (d) radiolarian (*Acanthometron elasticum*); (e) foram (*Globigerina bulloides*); (f) diatom (*Odontella sinensis*); (g, h) brown algae (*Undaria pinnatifida*, *Sargassum fusiforme*, respectively); (i, j) red algae (*Plocamium telfairiae*, *Amphiroa beauvoisii*, respectively); (k, l) green algae (*Ulva linza*, *Caulerpa okamurae*, respectively); (m, n) seagrasses (*Zostera marina*, *Halophila ovalis*, respectively) (c, d redrawn after Hertwig (1879) and Fauré-Fremiet (1924))

mastax) includes calcareous jaws. They usually reproduce parthenogenetically; and their males are generally reduced or absent.

*Platyhelminthes* (flatworms) are unsegmented, soft-bodied, flattened animal. They lack an anus and a pharyngeal opening takes in food and expels waste.

Turbellarians are frequently found in intertidal and shallow waters. They are mostly free-living with ribbon-like or leaf-like shapes. They are simultaneous hermaphrodites and fertilize eggs internally by copulation. Embryos develop into a Müller's larva which has eight-fold symmetry with several paired and unpaired lobes.

*Nemertea* (ribbon worms) are slender, unsegmented, sometimes dorsoventrally flattened animals. They are often carnivorous, feeding on small invertebrates and have a large proboscis, which is normally retained in a rhynchocoel. Respiration occurs over the surface of the body. All reproduce sexually, and most species are dioecious. Embryos develop either directly to form juveniles or to form planuliform larvae or pilidium larvae.

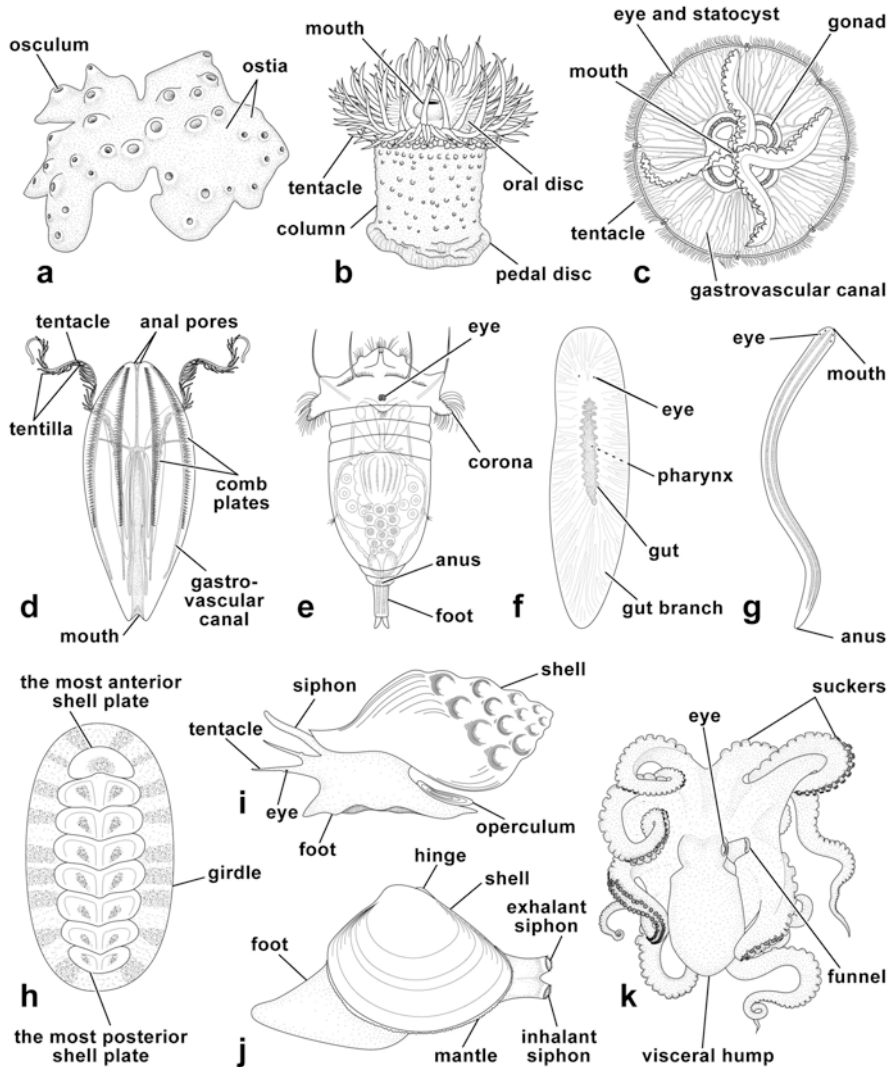
*Mollusca* is the second most diverse group of animals, usually with a head, a visceral mass, and a ventral foot, as well as a mantle with a cavity used for breathing and excretion. Four classes are common in intertidal and shallow waters around Japan (Fig. 3.3).

- Polyplacophora (chitons) have a dorsal shell composed of 7–8 plates encircled by a girdle ornamented with scales, spicules, bristles, or hairy tufts and having an armored tongue (radula) to rasp off and grind down small sessile invertebrates and algae. They are dioecious, and fertilization is usually external. Embryos develop into planktonic trochophore larvae.
- Gastropoda (limpets, abalones, snails, whelks, cowries, sea slugs) have a single, often dextrally coiled, shell, a well-defined head with eyes and two or four sensory tentacles, a radula, and a muscular foot. They are generally dioecious, and fertilization is external or internal. Embryos generally develop into planktonic veliger larva although some groups lay eggs from which small snails hatch out.
- Bivalvia (clams, oysters, cockles, mussels, scallops) have shell consisting of two hinged parts with respiratory gills modified for filtration (= ctenidia). They lack a head and radula. They are generally dioecious, and fertilization is usually external. Embryos generally develop into planktonic trochophore and veliger larvae.
- Cephalopoda (squid, cuttlefish, octopus, nautilus) have a prominent head, well developed eyes, and circumoral arms often with suckers, chitinous beaks, and a funnel. They are dioecious, and fertilization is internal. Embryonic development is direct, without larval stage.

*Annelida* was, in the traditional taxonomy, split into three major groups: Polychaeta, Oligochaeta (earthworms), and Hirudinea (leeches). However, now the Pogonophora, Echiura, and Sipuncula, previously regarded as separate phyla, are regarded as groups in polychaete annelids. Annelids usually have multiple segments of similar morphology (homonomous metamery). Each segment has a septum dividing it from neighboring segments, and the excretory, locomotory, and respiratory organs are generally repeated in each segment. Echiura and Sipuncula show no obvious signs of segmentation. In Japan polychaetes and sipunculids are commonly found in intertidal and shallow waters.

- Polychaeta (rag worms, lugworms, bristle worms, bloodworms, sea mice) is one of most common taxa in marine environment. Segmentation is well developed,





**Fig. 3.3** Basal metazoans and spiralian protostomes, (a) sponge (*Haliciona cinerea*), (b) sea anemone (*Anthopleura uchidai*), (c) jellyfish (*Aurelia coerulea*), (d) comb jelly (*Hormiphora palmata*), (e) rotifer (*Synchaeta vorax*), (f) flatworm (*Notoplana humilis*), (g) ribbon worm (*Nemertopsis gracilis*), (h) chiton (*Acanthopleura japonica*), (i) snail (*Neptunea arthritica*), (j) clam (*Meretrix lusoria*), (k) octopus (*Octopus vulgaris*) (b–e, h–k redrawn after Jatta (1896), Rousselet (1902), Komai (1918), Uchida (1936), Uchida et al. (1947), Utinomi (1951), Utinomi and Motoda (1955), and Okada et al. (1965))

and each segment bears a pair of parapodia with setae or bristles. The head has short sensory projections (palps) and tentacles. They are generally dioecious and fertilization is generally external. Embryos develop into planktonic trochophore larvae.

- Sipuncula (peanut worms) have a worm-like body that is divided into an unsegmented trunk and a narrower, retractable anterior section (introvert). The mouth is surrounded by ciliated tentacles which are used to gather organic detritus from the water or seabed substratum and these also function as gills. They are generally dioecious, and fertilization is generally external. Embryos develop into planktonic trochophore larvae.

*Bryozoa* (moss animals) are sessile colonial animals that typically encrust rocky surfaces, shells, or algae. They have a specialized feeding structure called a lophophore, a crown of tentacles that surround the mouth. The mouth opens into a U-shaped gut, and the anus is located just outside the lophophore. Individual members of a colony are called zooids. Asexual reproduction occurs by budding off new zooids as the colony grows. Most bryozoans are hermaphroditic and brood their eggs within the zoecium or in ovicells. The most characteristic pelagic larval type is the cyphonautes, which has a triangular shape and an apical tuft of cilia.

*Brachiopoda* (lamp shells) also have a lophophore and an epithelial mantle with two hard shells with a dorsal (brachial) valve and a ventral (pedicle) valve. They were very abundant in the Palaeozoic. Extant brachiopods are divided into two classes; Inarticulata (orders Lingulida and Acrotretida) and Articulata (orders Rhynchonellida, Terebratulida, and Thecideidina). They are generally dioecious, and embryos develop into lobate larvae.

### **Ecdysozoa**

*Arthropoda* is the largest animal phylum, in terms of numbers of described species, characterized by having a segmented body with paired and jointed appendages on segments. Crustaceans are the most abundant animals in the sea.

- Pycnogonida (Chelicerata) (sea spiders) have bodies divided into a cephalon and a trunk. The cephalon bears an ocular tubercle with four eyes on the dorsal surface, an anterior triradiate proboscis, and three pairs of appendages, chelifores, palps, and ovigers. The trunk consists of four segments, each of which bears a pair of very long ambulatory legs. They are generally dioecious and fertilization is external. The males carry the fertilized eggs on the ovigers. Embryos hatch into protonymphon larvae.
- Cirripedia (Crustacea: Maxillopoda, barnacles) are sessile and settle permanently on rock surfaces and other hard substrata. They secrete calcareous plates to form an exoskeleton and they filter and trap particles of organic material by means of cirri, which are feathery. Most barnacles are hermaphroditic and generally have a very long penis. Embryos are incubated in the shell and hatch into planktonic nauplius, metamorphose into the cyprids, and settle on hard surfaces.
- Copepoda (Crustacea: Maxillopoda: Copepoda) are abundant in the zooplankton, although some species are benthic. The head section is usually rounded with long antennae. There are usually nine trunk segments. The anterior segments bear swimming appendages, while the posterior segments taper, ending in a pair

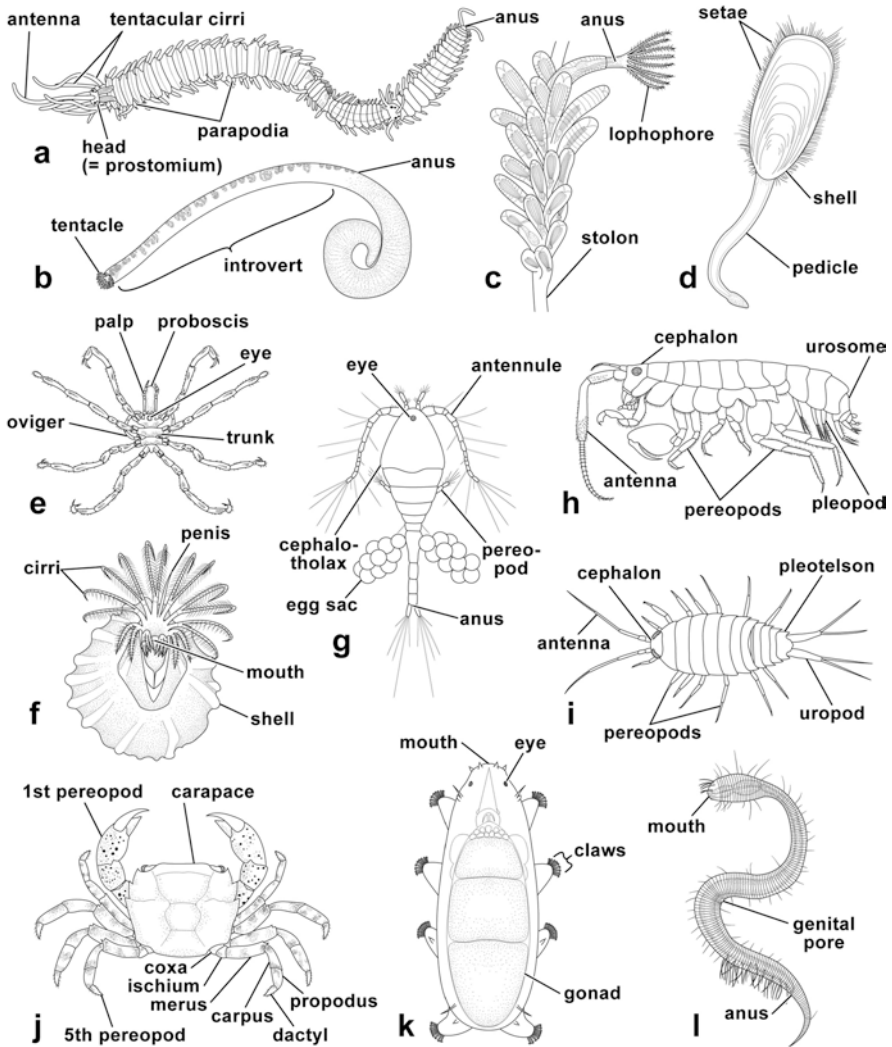
of caudal rami at the base of the abdomen. They are generally dioecious and fertilization is internal. Embryos develop into nauplius larvae.

- Amphipoda (Crustacea: Malacostraca: Peracarida) are usually benthic, laterally flattened crustaceans with the head region (cephalon) covered by cephalic shield, the thorax (pereon) bearing eight pairs of appendages, the first of which are used as accessory mouthparts, and the abdomen (pleon) divided into a pleosome bearing three pairs of legs (pleopods) and the urosome comprising three pairs of uropods and a telson. They are generally dioecious and fertilization is internal. Embryos are brooded by the female in a marsupium and hatch as juveniles.
- Isopoda (Crustacea: Malacostraca: Peracarida) are benthic dorsoventrally flattened crustaceans with a head (cephalon) covered by cephalic shield with two pairs of antennae, seven pairs of jointed limbs on the thorax, five pairs of branching appendages on the abdomen that are used for respiration with one or more segments, starting with the sixth segment, fused to the telson to form a pleotelson. They are generally dioecious and fertilization is internal. Females brood embryos in a pouch under their thorax that hatch as manca larvae.
- Decapoda (Crustacea: Malacostraca: Eucarida) include shrimps, lobsters, and crabs and are abundant with some providing important fishery resources in Japan. Their head and thorax is covered by a carapace. The thorax appendages include the first through third maxillipeds and first through fifth pereopods. The abdominal appendages include the first through sixth pleopods (the last of which are called uropods). In general, they are dioecious and fertilization is internal. Embryos develop into nauplius or zoea and metamorphose into megalopa.

*Tardigrada* (water bears) are microscopic and have a head, three body segments each with a pair of legs, and a caudal segment with a fourth pair of legs. They live in almost every habitat on Earth from mountaintops to the intertidal and from shallow waters to the deep sea. Their ability to enter anabiotic dormancy enables them to survive extreme environmental conditions. They reproduce asexually (parthenogenesis) or sexually. Embryonic development is direct, without larval stages. Growth occurs through a series of molts.

*Nematoda* (roundworms) is a highly diverse phylum of worm-like animals that are unsegmented and generally tapered at both ends. The epidermis is covered by a thick collagenous cuticle, which is periodically molted as it grows. The mouth generally contains elaborate, cuticular (horny) teeth, plates, or a hollow spear. Some are parasitic. Marine free-living species are generally dioecious, fertilization is internal, and they produce larvae, which appear essentially identical to the adults. They are very abundant members among the interstitial fauna and play an important role in the decomposition process, aiding recycling of nutrients in marine environments.

*Chaetognatha* (arrow worms) have an elongated, transparent body with lateral and caudal fins. Around the head, there are a pair of eye spots and a mouth surrounded by grasping spines. Cerebral ganglion at the dorsal side of the head and ventral subenteric ganglion are developed. They are hermaphroditic, developing testis and ovaries simultaneously. Most species are planktonic. Some benthic species have adhesive organs to attach to the substratum (Fig. 3.4).



**Fig. 3.4** Spiralian and ecdysozoan protostomes, (a) bristle worm (*Myrianida convoluta*), (b) peanut worm (*Phascolosoma scolops*), (c) moss animal (*Amathia imbricata*), (d) lamp shell (*Lingula anatina*), (e) sea spider (*Ammothea hilgendorfi*), (f) barnacle (*Fistulobalanus albicostatus*), (g) copepod (*Oithona nana*), (h) amphipod (*Trinorchestia trinitatis*), (i) isopod (*Ligia exotica*), (j) crab (*Hemigrapsus sanguineus*), (k) water bear (*Echiniscoides sigismundi*), (l) roundworm (*Drepanonema* sp.) (a, c, e, g, h, j–l redrawn after Uchida et al. (1947), Tokioka (1949), Utinomi and Motoda (1955), Imajima (1966), and Pollock (1975); (i) drawn by Dr. Michitaka Shimomura, Seto Marine Biological Laboratory, Kyoto University)

**Bilateria: Deuterostomia**

*Echinodermata* include sea urchins, starfishes, brittle stars, feather stars, and sea cucumbers. They have an internal skeleton covered with spines and skin. This skeleton is composed of calcareous spicules. The major body plan is pentaradial symmetry, with five body units arranged in a circle around a central disc. Echinoderms have a unique water vascular system that is a network of hydraulic canals. The system runs throughout the body, usually with numerous tube feet that serve for locomotion, food handling, and respiration. Many of them are common inhabitants of coastal tide pools. Most species are dioecious, produce planktonic larvae which are bilaterally symmetrical, unlike their parents.

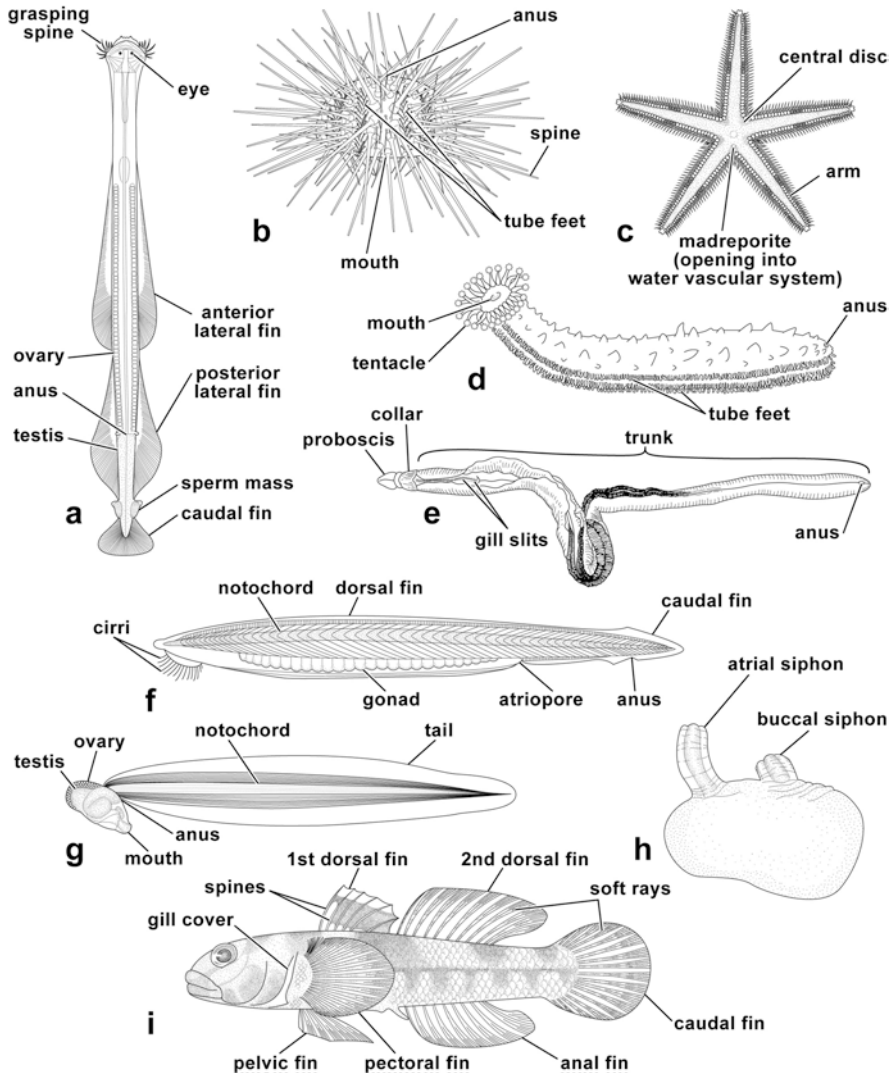
*Hemichordata* consists of three classes, of which the Enteropneusta (acorn worms) commonly inhabit mucus-lined burrows on sandy or muddy bottoms in coastal waters. Acorn worms have a bilaterally symmetrical body divided into three sections, a conical proboscis, a short collar, and a long trunk. They have pharyngeal gill slits and an open circulatory system and a complete digestive tract. The most distinguishing characteristic of the hemichordates is a primitive form of notochord, called a stomochord that contains a nerve system. This tube provides the basis for placing the hemichordates as a sister group to chordates. They are dioecious (partially hermaphroditic) and many species have a planktonic tornaria larval stage.

*Chordata* (chordates) contains some of the most familiar animals in the world, including humans. They have a notochord and pharyngeal gill slits are also present like in hemichordates. All chordates have a post-anal tail that is located posterior to the anal opening. Chordates consist of the following three major groups.

Cephalochordata (lancelets) have a translucent fish-like body, lacking a true skeleton and distinct brain/sense organs. They have the notochord along the whole elongated body. They use gill slits for filter feeding, causing water flow from mouth to an atriopore near an anus. Oral cirri work as a coarse filter. They are dioecious and produce planktonic larvae which resemble the benthic adults.

Urochordata (sea squirts, salps, and larvaceans) has the notochord along a tail. Sea squirts and salps have the notochord only in the planktonic larval stage (to so called tadpole larva). After growing up, they lose the notochord and further develop the gill slits and buccal/atrial siphons for filter feeding. Larvaceans have the notochord and secrete a house around the body, which works as a filter for suspension feeding instead of gill slits. Urochordates are hermaphroditic (partially dioecious) and are strictly marine (Fig. 3.5).

Vertebrata is the largest group among the three subphyla contained in chordates. Although the most distinctive morphological feature of chordates is to possess a notochord, almost all vertebrates convert their notochord into a vertebral column or backbone. The subphylum is one of the best known of all groups of animals, including mammals, birds, reptiles, amphibians, and fishes. Among them, the fishes are typically divided into three major groups: jawless fishes, cartilaginous fishes, and bony fishes. Bony fish consist of the classes Sarcopterygii (lobe-finned fishes) and Actinopterygii (ray-finned fishes); the latter diverse number of species includes about half of all known living vertebrates and 96% of all fish species. Ray-finned fishes have many of the characteristics common to all chordates: pharyngeal slits, a nerve cord,



**Fig. 3.5** An phylogenetically enigmatic protostome and deuterostomes, (a) arrow worm (*Zonosagitta bedoti*), (b) sea urchin (*Heliocidaris crassispina*), (c) starfish (*Astropecten kagoshimensis*), (d) sea cucumber (*Apostichopus japonicus*), (e) acorn worm (*Balanoglossus misakiensis*), (f) lancelet (*Branchiostoma japonicum*), (g) larvacean (*Oikopleura gracilis*), (h) sea squirt (*Herdmmania momus*), (i) fish (*Bathygobius fuscus*) (a–i redrawn after Tokioka (1940, 1955), Utinomi and Motoda (1955), Okada et al. (1965), and Ikeda and Inaba (1971))

and body wall muscles arranged in myotomes, or segmented blocks. As the name suggests, their fins are supported by parallel bony rays. The swim bladder is also a unique feature of most ray-finned fish, enabling them to maintain buoyancy.

## References

- Asakura, A., & Watanabe, S. (2005). *Hemigrapsus takanoi*, new species, a sibling species of the common Japanese intertidal crab *H. penicillatus* (Decapoda: Brachyura: Grapsoidea). *Journal of Crustacean Biology*, 25(2), 279–292.
- Fauré-Fremiet, E. (1924). Contribution à la connaissance des infusoires planctoniques. *Bulletin biologique de la France et de la Belgique, Supplement*, 6, 1–171.
- Fujikura, K., Lindsay, D., Kitazato, H., Nishida, S., & Shirayama, Y. (2010). Marine biodiversity in Japanese waters. *PLoS One*, 5(8), e11836. <https://doi.org/10.1371/journal.pone.0011836>
- Graham, L. E., & Wilcox, L. W. (2000). *Algae*. Upper Saddle River, NJ: Prentice-Hall.
- Hertwig, R. (1879). *Der Organismus der Radiolarien*. Jena: Gustav Fischer.
- Ikeda, K., & Inaba, A. (Eds.). (1971). *Illustrated animal anatomy*. Tokyo: Morikita Shuppan, (in Japanese).
- Imajima, M. (1966). The Syllidae (polychaetous annelids) from Japan (II). Autolytinae. *Publications of the Seto Marine Biological Laboratory*, 14(1), 27–83.
- Jatta, G. (1896). I Cefalopodi viventi nel Golfo di Napoli (sistematica): Monografia. In *Fauna e flora del Golfo di Napoli* (Vol. 23). Naples: Stazione Zoologica di Napoli.
- Komai, T. (1918). On ctenophores of the neighbourhood of Misaki. *Annotationes Zoologicae Japonenses*, 9(4), 451–474.
- Lee, R. E. (2018). *Phycology* (5th ed.). Cambridge: Cambridge University Press.
- Nelson, J. S., Grande, T. C., & Wilson, M. V. H. (2016). *Fishes of the world* (5th ed.). Somerset: Wiley.
- Okada, Y., Uchida, S., & Uchida, T. (Eds.). (1965). *New illustrated encyclopedia of the fauna of Japan*. Tokyo: Hokuryukan, (in Japanese).
- Pollock, L. W. (1975). Observations on marine heterotardigrada, including a new genus from the western Atlantic Ocean. *Cahiers de Biologie Marine*, 16(1), 121–132.
- Rousselet, C. F. (1902). The genus *Synchaeta*: A monographic study, with descriptions of five new species. *Journal of the Royal Microscopical Society*, 22(4), 393–411.
- Tokioka, T. (1940). Phylum Chaetognatha. *Fauna Nipponica*, 5(2), 1–129, (in Japanese).
- Tokioka, T. (1949). Droplets from the plankton net. *Publications of the Seto Marine Biological Laboratory*, 1(2), 65–73.
- Tokioka, T. (1955). General consideration on Japanese appendicularian fauna. *Publications of the Seto Marine Biological Laboratory*, 4(2–3), 251–261.
- Uchida, S., et al. (1947). *Illustrated encyclopedia of the fauna of Japan (exclusive of insects)* (Revised ed.). Tokyo: Hokuryukan, (in Japanese).
- Uchida, T. (1936). Class Scyphozoa. *Fauna Nipponica*, 3(2), 1–94, (in Japanese).
- Utinomi, H. (1951). *Seaside school “Umibe no kyoushitsu”*. Tokyo: Bunshodo, (in Japanese).
- Utinomi, H., & Motoda, S. (1955). *Method of course in marine biology: Observations of shallow-water animals*. Tokyo: Nakayama Shoten, (in Japanese).



Kazuo Inaba, Ken-ichiro Ishida, and Takeshi Nakayama

## Abstract

The term ‘plankton’ was first used by Victor Hensen in 1887 for wanderers or drifters in the open water column, being distributed from neritic or coastal area to the deep sea. They live in the water column for their entire life (holoplankton) or may have a benthic life history stage (meroplankton). In the latter case, they spend part of their life in the pelagic zone as suspension feeders, as seen in the larvae of marine benthic invertebrates, which undergo metamorphosis into adults as either suspension feeders or deposit feeders. Some of them, particularly some zooplankton, are highly motile but are passive to water movement and oceanic currents. This is a property distinct from the nekton, which can move against the water movement and are usually difficult to catch in plankton nets.

## 4.1 Overview

The word “plankton” erroneously brings to mind a group of tiny organisms. In fact, marine plankton ranges in size from nanometers to meters: some jellyfish are several tens of meters in size including the tentacles, whereas some viruses are several hundred nanometers. For descriptive purposes, marine plankton are classified by size into the following categories: femtoplankton (20–200 nm), picoplankton (0.2–2.0  $\mu\text{m}$ ), nanoplankton (2.0–20  $\mu\text{m}$ ), microplankton (20–200  $\mu\text{m}$ ), mesoplankton (0.2–20 mm), macroplankton (2.0–20 cm), and megaplankton (20 cm or more).

---

K. Inaba (✉)

Shimoda Marine Research Center, University of Tsukuba, Shimoda, Shizuoka, Japan  
e-mail: [kinaba@shimoda.tsukuba.ac.jp](mailto:kinaba@shimoda.tsukuba.ac.jp)

K.-i. Ishida · T. Nakayama

Graduate School of Life and Environmental Sciences, University of Tsukuba,  
Tsukuba, Ibaraki, Japan



Plankton have acquired several morphological or functional properties for living in the pelagic zone by floating. For example, macro- and megaplankton tend to be covered with gelatinous materials, including the mesoglea of cnidarians and ctenophores and the gelatinous ‘house’ of larvaceans. Aside from the accumulation of lipids by photosynthesis in phytoplankton, small plankton became flat (*Coscinodiscus*, diatoms) or developed spines and other projections (*Chaetoceros*, diatoms; phyllosoma larvae of lobsters) to increase buoyancy.

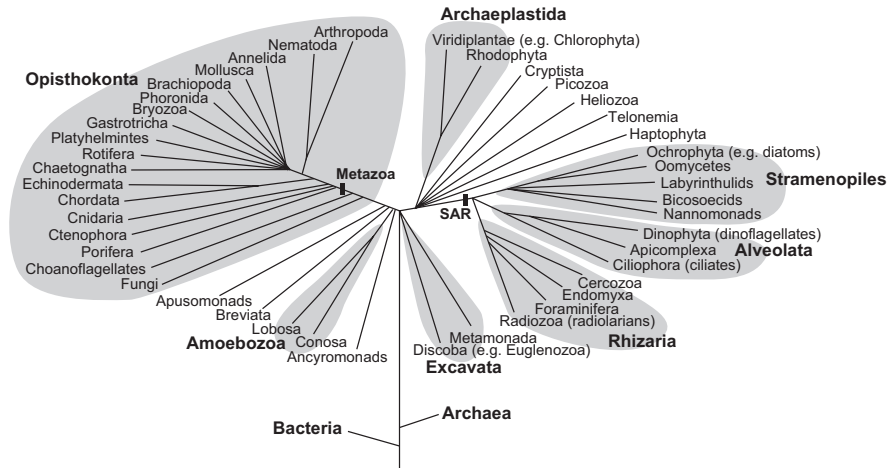
Marine plankton are highly diverse and include to a wide range of eukaryotic phyla, but they are often divided into phytoplankton and zooplankton. Planktonic prokaryotes (bacteria and archaea) and viruses are the most abundant members of the plankton (also see Chap. 31). Photosynthetic bacteria (cyanobacteria) play a major role in the oceanic food web while eukaryotic phytoplankton distributed in the upper pelagic region (photic zone) use photosynthesis to feed themselves (autotrophy). Approximately 95% of marine productivity is derived from phytoplankton which are then eaten by zooplankton (primary consumers; heterotrophy) which are then eaten by secondary consumers and so on up the food web. Phytoplankton supply both particulate organic matter (POM) and dissolved organic matter (DOM) through leakage or death. Viruses and decomposers, such as bacteria and heterotrophic protists, drive a microbial trophic cycle known as the microbial loop, which is essential for carbon and nutrient cycling (Fig. 31.1).

Plankton migrate daily in the water column. The phytoplankton increase their buoyancy by the accumulation of lipids through photosynthesis and stay near the surface during the daytime but gradually migrate down from the surface at night. The zooplankton migrate predominantly to avoid visual predators, swimming down into the water column by day and returning to the surface at night to graze. The distribution and abundance of plankton change seasonally and biogeographically and can be used as a bioindicator of ecosystem change. Under certain conditions phytoplankton and zooplankton can bloom. Dying coccolithophore blooms can be seen from space by satellite as the cells shed their calcium carbonate plates, or coccoliths, making the sea a milky white color. Some algal blooms can be harmful to marine fish and mammals, and ultimately marine ecosystems. The occurrence of harmful algal blooms is natural but can be triggered by eutrophication in coastal areas. Blooms of gelatinous zooplankton, such as jellyfish (cnidarians or ctenophores) can cause problems in fisheries around Japan because they clog nets and consume larval fish.

---

## 4.2 Phylogenetic Diversity of Plankton

Plankton support food webs and ecosystems in the ocean. A study of the diversity of plankton can inform us about the evolution of eukaryotes (Fig. 4.1) which are thought to be evolved from a hypothetical common ancestor (last eukaryotic common ancestor, LECA). They are classified into five ‘supergroups’: Opisthokonta (metazoan + fungi), Amoebozoa, Excavata, the SAR group (Stramenopiles, Alveolata, and Rhizaria), Archaeplastida, and some small groups (e.g. Haptophyta, Cryptista, Apusomonads) (Adl et al. 2012; Baldauf 2003; Burki 2009; Roger and Simpson 2009; Stechmann and Cavalier-Smith 2002). Eukaryotic marine plankton



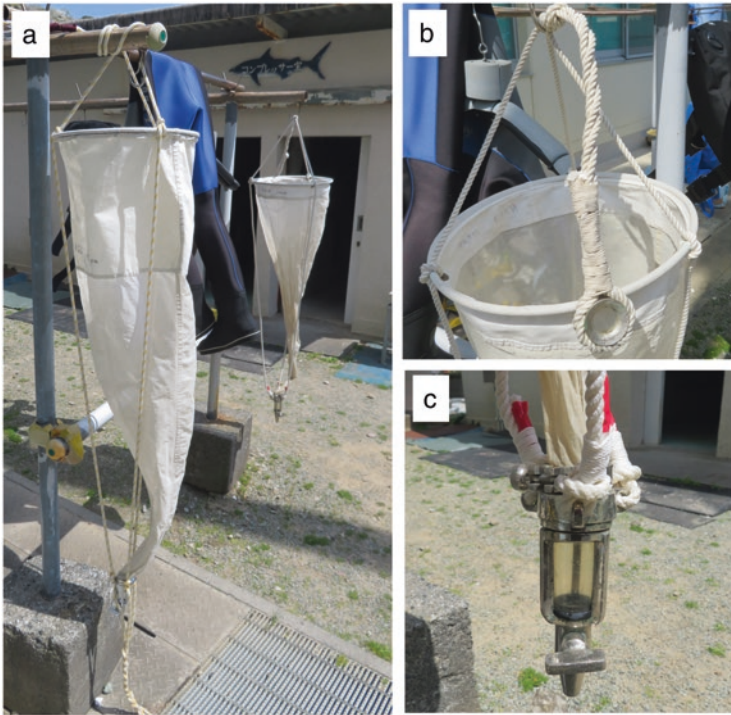
**Fig. 4.1** A widely accepted phylogenetic tree of eukaryotes. Eukaryotes are composed of five supergroups (Opisthokonta, Amoebozoa, Archaeplastida, SAR [Stramenopiles + Alveolata + Rhizaria], and Excavata), and other organisms not yet grouped

are found in all these supergroups and provide a great opportunity to learn about the evolution and diversity of the cells and body plans in eukaryotes.

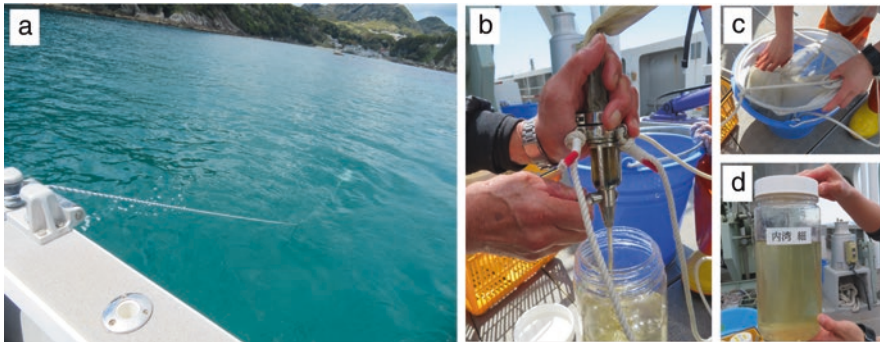
### 4.3 Sampling of Plankton for Observation and Analysis

Plankton are most commonly collected by a plankton net, which was first used by John Vaughan Thompson in 1816 and also used by Charles Darwin in 1832 aboard HMS *Beagle*. A plankton net is basically composed of a cone-shaped nylon mesh net, with the towing line connected to three-point bridle for holding the plankton net, a cod end, and a weight (Fig. 4.2). The cod end is connected to a metal valve or a rubber tube with a large clip as the outlet. Plankton can be collected vertically or horizontally. For quantitative purposes, a flow meter can be attached at the opening. Plankton abundance can be calculated from the water volume passing through the net and the number of plankton counted per volume of sample for counting. Measurements of several physical parameters are important to record the condition of the plankton collected. For these purposes, a conductivity–temperature–depth (CTD) apparatus and other sensors can be attached to the plankton net or used separately for measurements at the same site. There are several types of plankton nets differing in their length, mouth diameter, and type of filtering material, represented by ones for collection in standard investigation, such as NORPAC (North Pacific Standard) and WP-2 (UNESCO Working Party 2) nets. For large-scale plankton sampling, Continuous Plankton Recorder (CPR) is the most successfully used device.

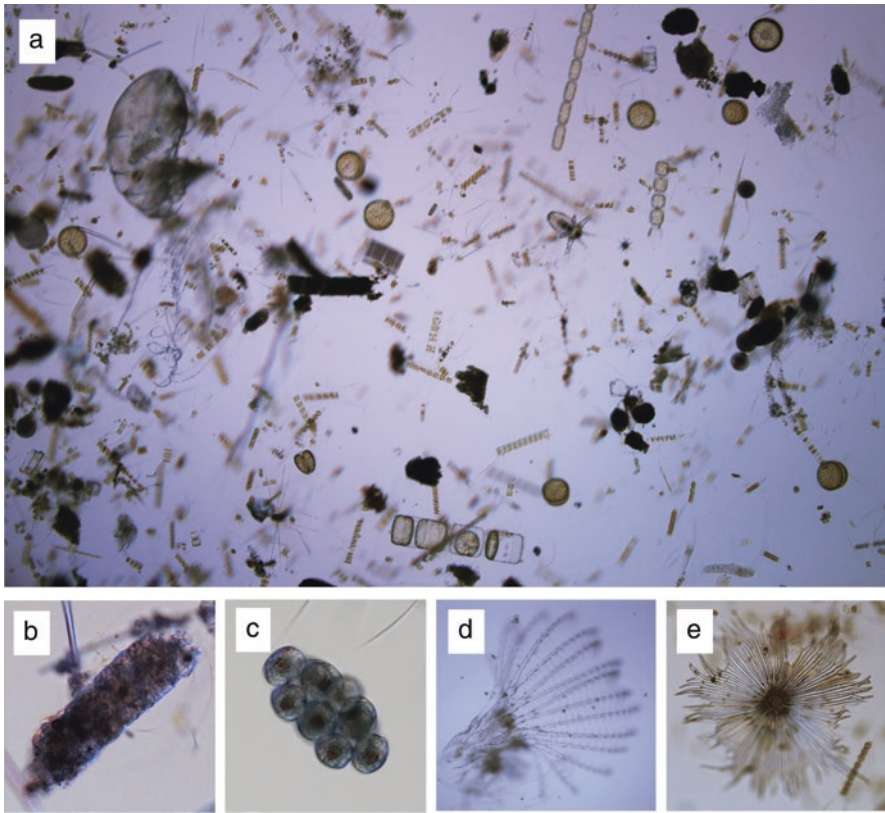
For collecting unicellular organisms, a fine net (20- $\mu\text{m}$  mesh size) is often used. For large phytoplankton and most zooplankton, we use 100–150- $\mu\text{m}$  or 300- $\mu\text{m}$  mesh nets, respectively. For a rocky shore or a pier, it is simple to collect plankton by casting a plankton net with a long rope or lowering it vertically and then



**Fig. 4.2** Plankton nets. (a) Whole appearance with a net and connecting lines. (b) Opening with three-point bridle for holding the plankton net. (c) The cod end connected to a metal valve (horizontal position, open state)



**Fig. 4.3** Sampling of plankton. (a) Plankton net with a rope towed from a boat. (b) Recovering the plankton concentrated by a plankton net by turning the bulb from vertical to horizontal position. (c) Plankton still trapped on the net surface can be recovered by rinsing the net and collecting the content into the same bottle. (d) All are recovered in a bottle. If you look into the bottle, you can see the freshest plankton (only those in large size) on site



**Fig. 4.4** The first step for the selection of plankton for observation. (a) A low magnification image of concentrated plankton. Note that many diatoms and copepods are seen in this field. (b–e) Some enigmatic materials in the plankton sample. You often come across the materials that do not appear in a general textbook for plankton. (b) Feces of a copepod. (c) An egg mass of a copepod. (d) A debris of barnacle cirri. (e) Stellate hair of a land plant

retrieving it by slowly pulling the rope; otherwise a boat can be used to tow the net slowly (Fig. 4.3a). Before collecting the plankton, the net should be rinsed with the sample water. The cod end should be completely closed by turning the valve to the vertical position. Then, the plankton net is lowered to the water surface from the side of the boat. The towing time is usually 5–10 min; otherwise the net becomes crowded leading to damage of the organisms. After this time, the plankton net is slowly retrieved at a speed less than 1 m/s. The plankton sample is collected into a small bottle filled with filtered seawater or natural seawater by opening the cod end by turning the valve to the horizontal position (Fig. 4.3b). To wash out and recover the plankton trapped on the surface of the net, the net is immersed again and moved up and down to rinse the plankton to the cod end (Fig. 4.3c, d).

The dense plankton are diluted by natural or filtered seawater in container. Lower temperature and aeration may help keep the plankton alive. It is also good to put the diluted sample in a petri dish with a lid and keep it in a refrigerator for a few days.

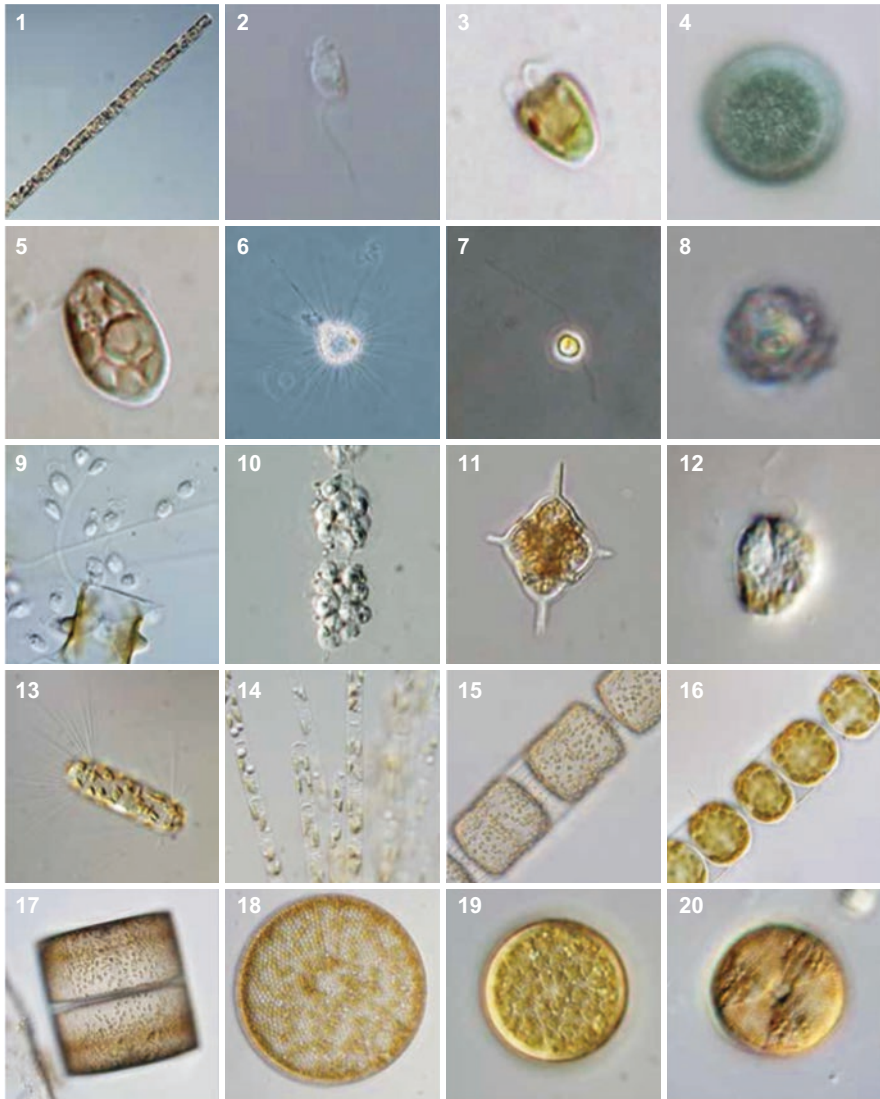
A wide-mouth pipette with a bulb can prevent damage to large zooplankton. Polyethylene disposable transfer pipettes also help. It is also effective to observe plankton using a watch glass, particularly for observation of a diluted sample.

The plankton can be observed using a microscope or a stereomicroscope, depending on the magnification needed for identification. It is best to use a microscope with dark-field, phase-contrast, or differential interference contrast system for detailed observation of cellular structures. For observation, the samples, particularly fast-moving zooplankton, can be immobilized in several ways: 10% neutralized formalin, 70% ethanol, 2.5% glutaraldehyde, 30% glycerin, or 3.5% MgCl<sub>2</sub> in seawater. The method should be selected in order to minimize damage and deformation of the plankton. For molecular analysis, the samples can be stored in ethanol (for DNA) or collected by a centrifuge and quickly frozen until needed for subsequent procedures (for RNA).

#### 4.4 Representative Plankton Species Collected Around Japan Coasts

In plankton samples you can often see diatoms, dinoflagellates, cyanobacteria, and copepods (Fig. 4.4a). Debris or feces of some plankton or some non-marine materials from land are sometimes found in such sample (Fig. 4.4b–e). Since plankton samples contain species in a wide range of eukaryotic phyla, including sometimes minor or hard-to-find groups, it is fun to look into the sample carefully. For practical help, major species of marine plankton are listed in Fig. 4.5 with their phylogenetic classifications. You can also consult several books (Castellani and Edwards 2017; DeBoyd and Johnson 1996; Larink and Westheide 2011; Sardet 2015; Yamaji 1966).

**Fig. 4.5** (continued) Dinoflagellates (Alveolata, Dinophyta). (43) *Procentrum*. (44) *Dinophysis*. (45, 46) *Ceratium* (*Tripos*). (47, 48) *Protoperdinium*. (49) *Scrippsiella*. (50) *Karlodinium*. (51) *Polykrikos*. (52) *Noctiluca*. (53) *Ebria* (Rhizaria, Cercozoa). (54) *Protocystis* (Rhizaria, Cercozoa). (55–57) Radiolarians (Rhizaria, Radiozoa). (55) *Acanthometra*. (56) *Peridium*. (57) *Sticholonche*. (58–60) Foraminiferans (Rhizaria, Foraminifera). (61–119) Metazoa (Opisthokonta). (61–68) Cnidaria. (61) *Podocoryne*. (62) *Hydrocoryne*. (63) *Abylopsis*. (64) *Muggiaea*. (65) *Gonionemus*. (66) *Chrysaora*. (67) *Aurelia*. (68) *Aequorea*. (69–72) Ctenophora. (69) *Ocyropsis*. (70) *Hormiphora*. (71) *Beroe*. (72) *Bolinopsis* larva. (73) *Notoplana* larva (Platyhelminthes). (74) *Discina* larva (Brachiopoda). (75, 76) Actinotroch larvae (Phoronida). (77) Cyphonaute larvae (Bryozoa). (78) *Brachionus* (Rotifera). (79) *Sagitta* (Chaetognatha). (80) Pelagosphera larva (Sipuncula). (81, 82) Nectochaete larvae (Anellida). (83–101) Arthropoda. (83–93) Copepoda. (83) *Oncaea*. (84) *Oithona*. (85) *Acartia*. (86) *Calocalanus pavo*. (87) Nauplius larva. (88) *Calanus*. (89) *Penilia*. (90) *Macrosetella*. (91) *Sapphirina auronitens*. (92) *Copilia* (male). (93) *Copilia* (female). (94) *Evadne* (Branchiopoda, Cladocera). (95) *Vargula* (Ostracoda). (96) Nauplius larva (Cirripedia). (97) Cypris larva (Cirripedia). (98) *Lucifer* (Decapoda). (99) Zoea larva (Decapoda, Pleocyemata). (100) Protozoa larva (Decapoda, Pleocyemata). (101) Zoea larva (Decapoda, Brachyura). (102–107) Mollusca. (102) Chiton trochophore (Polyplacophola). (103) Egg of *Nodilittorina* (Gastropoda). (104) Veliger larvae (Bivalvia). (105) Veliger larva (Gastropoda). (106) *Creseis* (Gastropoda, Pteropoda). (107) *Limacina* (Gastropoda, Pteropoda). (108–111) Echinodermata. (108, 109) Echinopluteus larvae (Echinoidea). (110) Ophiopluteus larvae (Ophiuroidea). (111) Bipinnaria larva (Asteroidea). (112) Tornaria larva (Hemichordata). (113–119) Chordata. (113) Tadpole larva (Ascidiacea). (114, 115) *Oikopleura* (Appendicularia). (116) *Dilium* (Thaliacea). (117–119) Fish embryo or larva (Actinopterygii, Chordata)

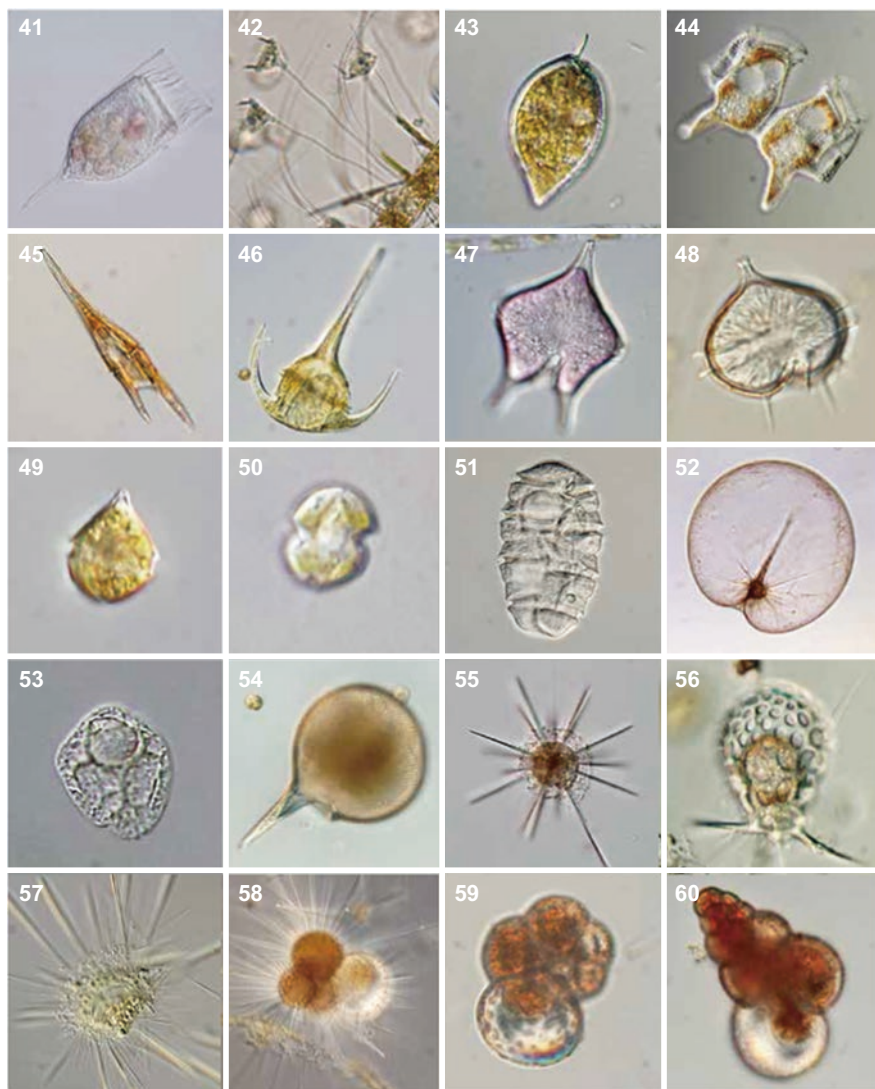


**Fig. 4.5** Typical marine plankton seen around Japan. (1) *Trichodesmium* (Bacteria, Cyanobacteria). (2) *Neobodo* (Excavata, Euglenozoa). (3) *Pyramimonas* (Archaeplastida, Chlorophyta). (4) *Neorhodella* (Archaeplastida, Rhodophyta). (5) *Rhodomonas* (Cryptista, Cryptophyta). (6) Centrohelid (Heliozoa). (7) *Chrysochromulina* (Haptophyta). (8) *Gephyrocapsa* (Haptophyta). (9–40) Stramenopiles. (9) *Bicosoeca* (Bicosoecia) on *Chaetoceros* (diatom). (10) *Solenicola* (Nanomonadea) on *Dactyliosolen* (diatom). (11) *Dictyocha* (Ochrophyta, Dictyochophyceae). (12) *Heterosigma* (Ochrophyta, Raphidophyceae). (13–40) Diatoms (Ochrophyta, Bacillariophyceae s.l.). (13) *Corethron*. (14) *Leptocylindrus*. (15) *Stephanopyxis*. (16) *Merosirea*. (17, 18) *Coscinodiscus*. (19) *Actinocyclus*. (20) *Actinoptycus*. (21) *Detonula*. (22) *Lauderia*. (23–25) *Thalassiosira*. (26) *Skeletonema*. (27, 28) *Rhizosolenia*. (29) *Guinardia*. (30) *Dactyliosolen*. (31) *Eucampia*. (32) *Ditylum*. (33) *Bacteriastrum*. (34, 35) *Chaetoceros*. (36) *Thalassionema*. (37) *Asterionellopsis*. (38) *Pleurosigma*. (39) *Meuniera*. (40) *Pseudo-nitzschia*. (41) *Favella* (Alveolata, Ciliophora). (42) *Vorticella* (Alveolata, Ciliophora) on *Chaetoceros* (diatom). (43–52)

(continued)



Fig. 4.5 (continued)



**Fig. 4.5** (continued)





**Fig. 4.5** (continued)



**Fig. 4.5** (continued)



**Fig. 4.5** (continued)

## References

- Adl, S. M., et al. (2012). The revised classification of eukaryotes. *The Journal of Eukaryotic Microbiology*, 59(5), 429–493.
- Baldauf, S. L. (2003). The deep roots of eukaryotes. *Science*, 300(5626), 1703–1706.
- Burki, F. (2009). Large-scale phylogenomic analyses reveal that two enigmatic protist lineages, Telonemia and Centroheliozoa, are related to photosynthetic chromalveolates. *Genome Biology and Evolution*, 1, 231–238.
- Castellani, C., & Edwards, M. (Eds.). (2017). *Marine plankton: A practical guide to ecology, methodology, and taxonomy*. Cambridge: Oxford Press.
- DeBoyd, L., & Johnson, K. B. (1996). *A guide to marine coastal plankton and marine invertebrate larvae*. Dubuque: Kendall/Hunt Publishing Company.
- Larink, O., & Westheide, W. (Eds.). (2011). *Coastal plankton: Photo guide for European seas*. München: Verlag Dr Friedrich Pfeil.
- Roger, A. J., & Simpson, A. G. B. (2009). Evolution: Revisiting the root of the eukaryote tree. *Current Biology*, 19, R165–R167.
- Sardet, C. (2015). *Plankton: Wonders of the drifting world*. Chicago: University of Chicago Press.
- Stechmann, A., & Cavalier-Smith, T. (2002). Rooting the eukaryote tree by using a derived gene fusion. *Science*, 297(5578), 89–91.
- Yamaji, I. (1966). *Illustrations of the marine plankton in Japan*. Osaka: Hoikusha Publishers.



# Marine Algae and Plants

# 5

Shigeki Wada, Ken-Ichiro Ishida, Michiyo Noda,  
and Hideki Abe

## Abstract

The broadly accepted definition of algae is ‘oxygenic photosynthesisers other than embryophyte land plants’, and multicellular algae are generally termed macroalgae. The numbers of green, brown, and red algal species are estimated to be approximately 1100, 1500, and 4000–6000, respectively, worldwide. Embryophytes living in marine environments are mainly seagrasses, which are angiosperms adapted to nearshore areas with soft sediment. Seagrasses are less diverse than macroalgae; there are less than 60 species worldwide. The three groups of macroalgae have different subcellular structures and evolutionary histories. Green and red algae evolved from a common ancestral photosynthetic eukaryote, which acquired their plastids through primary endosymbiosis, in which a cyanobacterium was engulfed by an ancestral eukaryotic host cell. Brown algae evolved by secondary endosymbiosis, in which a red alga was engulfed by a eukaryotic host protist. Because of this, green and red algae have plastids with two envelope membranes, while brown algae have plastids with four envelope membranes. The green and red algae differ in their photosynthetic pigment composition, thylakoid structure and storage products. The three

---

S. Wada (✉)

Shimoda Marine Research Center, University of Tsukuba, Shimoda, Shizuoka, Japan  
e-mail: [swadasbm@shimoda.tsukuba.ac.jp](mailto:swadasbm@shimoda.tsukuba.ac.jp)

K.-I. Ishida

Graduate School of Life and Environmental Sciences, University of Tsukuba,  
Tsukuba, Ibaraki, Japan

M. Noda

Pressed Seaweed Design Office, Izu, Japan

H. Abe

Hideki Abe Photo Office, Izu, Japan

© Springer Nature Singapore Pte Ltd. 2020

K. Inaba, J. M. Hall-Spencer (eds.), *Japanese Marine Life*,  
[https://doi.org/10.1007/978-981-15-1326-8\\_5](https://doi.org/10.1007/978-981-15-1326-8_5)

macroalgal groups became multicellular independently of each other from different unicellular ancestors. Both macroalgal and seagrass beds are very productive ecosystems as their photosynthesis per unit area can be the highest in the world. These macrophytes support biodiverse coastal ecosystems by providing energy and structural complexity.

---

## 5.1 Zonation of Macroalgae

Algae are defined as ‘oxygenic photosynthesisers other than embryophyte land plants’ (Cavalier-Smith 2016), and multicellular algae are termed macroalgae. Macroalgal habitats are distributed from intertidal to shallow subtidal zones. Physical conditions in intertidal zones (e.g., temperature, desiccation, and osmotic shock) are highly variable across the tidal level, and are major factors controlling zonation (Stephenson and Stephenson 1949; Davison and Pearson 1996). In the subtidal, spectral changes in sunlight depending on depth help explain macroalgal zonation; this is known as the ‘chromatic adaptation theory’ (Crossett et al. 1965). Due to high productivity (Mann 1973; Yokohama et al. 1987) and structural complexity provided by algae (Boström and Bonsdorff 1997), biodiversity in coastal ecosystems is maintained.

---

## 5.2 Collection of Macroalgae and Seagrass

We can sample macroalgae using a variety of methods depending on their habitats (e.g., hand collection, snorkeling, and SCUBA diving). Since there are a wide variety of macroalgal species (approximately 15,000 species, Andersen 1992), we identify the species based on information such as morphology, habitat and anatomical observations. The whole algal thallus, comprising the blade, stipe, reproductive organs, and holdfast, should be collected, because these are often helpful for species identification. Macroalgae are stored in containers after collection, but we should take care of the algae producing sulfuric acid (Sasaki et al. 1999). If such acid-producing algae die in the container, all other macroalgae would be damaged due to the low pH. Seagrasses are generally collected by SCUBA diving. Since their roots spread into the sediment, it is necessary to dig out the underground part. The collection of stranded algae is also possible, and we can sometimes get subtidal algae and seagrasses on the beach (Fig. 5.1).

---

## 5.3 Preparation of Macroalgal Dried Specimens

Specimens are important for species identifications. To preserve macroalgal individuals for long-term observations and morphological and molecular comparisons with other specimens of different localities and time periods, dried specimens are



**Fig. 5.1** Collection of macrophytes at Ebisu-Island, Shimoda, Shizuoka, Japan. Even though the area is shallow, we should wear life-jacket. Wet-suit is more preferable, because it protects body from injury

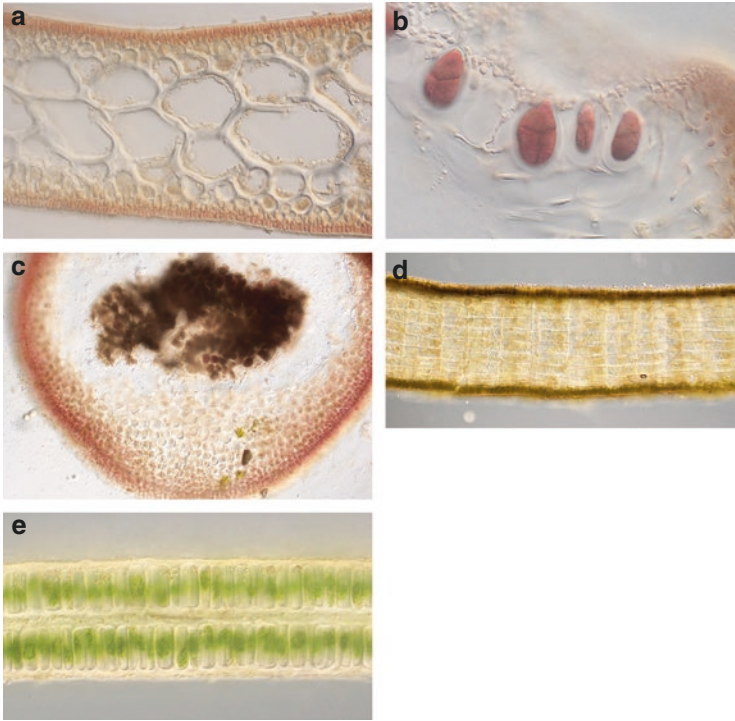
often prepared. The following is a summarized procedure of macroalgal dried specimen preparation:

- (1) Wash the algal thallus in seawater to remove dirt from the surface and soak in freshwater for several minutes (depending on the size and thickness of the specimen) to remove salt.
- (2) Arrange the specimen on mounting paper: soak the paper in freshwater, place the specimen on the paper, and shape the specimen on the paper under freshwater.
- (3) Remove the paper carefully from the water with the specimen on it, and leave it diagonally on a slanting mesh board for about 5 min so that excess water drips off.
- (4) Prepare sets of specimens sandwiched between blotting paper for drying: place a piece of blotter paper on corrugated cardboard, place the mounting paper with specimen on it, cover it with a cotton cloth, place another piece of blotting paper on top of it, and finally cover with corrugated cardboard. Repeat this until all specimens are set.
- (5) Drying: place the specimen-set (corrugated cardboard–blotter paper–mount with specimen–cloth–blotter paper–corrugated cardboard...) in a dryer and place a weight (e.g., concrete block) on top. Leave the specimen sets for about 3 days while circulating the air with the dryer.
- (6) Completion: ensure that the specimens are dry, remove the cardboard and blotter paper, and peel off the cloth carefully. Finally, place a label with the record of specimen onto each specimen mount.

#### 5.4 Morphological and Anatomical Observation of Macroalgae

For identification of macroalgae, observations of thallus organization and the reproductive structures are often required. An easy method for this is taking thin-sections and observing them under a microscope.

To make a thin-section slide, place a small piece of macroalgae, overlay another glass slide on top shifting 90 degrees, move a razor along the side of the upper



**Fig. 5.2** (a) Frond of *Gracilaria textorii*, (b) tetrasporangium of *Fushitsunagia atenata*, (c) carposporangium of *Fushitsunagia atenata*, (d) Frond of *Padina arborescens* and (e) Frond of *Ulva australis*

glass slide, repeatedly slicing the macroalga while slightly sliding the glass slide. Scattered water droplets (seawater) onto the resulting slices on the glass slide and cover with a cover glass to observe. Dye with a staining solution if necessary. A few examples of thin-sectioned macroalgae are shown in Fig. 5.2.

## 5.5 Pigment Composition and Spectral Change of Sunlight Along Depth

Green, brown, and red algae (Fig. 5.3) have different compositions of the accessory pigment chlorophyll *b*, fucoxanthin, and phycobiliproteins, respectively (Dring 1998; Kiang et al. 2007). Such differences in the composition relate to the fact that the absorption and scattering of sunlight is variable depending on the wavelength;





**Fig. 5.3** Representative species of green, brown, and red algae. *Ulva australis* (a), *Padina arborescens* (b), and *Asparagopsis taxiformis* (c) are shown

red light is more steeply attenuated with depth (Ramus et al. 1976). Therefore, algae living in deeper habitats (mainly red algae) can effectively utilize blue and green light using accessory pigments such as phycobiliproteins.

#### Method for Pigment Analysis with Thin-Layer Chromatography (TLC)

1. Remove epiphytes from the algal body carefully.
2. Grind algal tissues with silica-gel particles.
3. Add dimethyl ether, and centrifuge or spin down.
4. Spot a silica-gel plate (TLC plate) with the supernatant using a capillary tube.
5. Put the plates into a developing tank with a petroleum ether:acetone (7:3) solution.
6. Measure the distances of pigment ( $D_p$ ) and solvent front ( $D_s$ ) from the origin.
7. Calculate the retention factor ( $R_f$ ) values for each pigment ( $R_f = D_p/D_s$ ).

The operations should be performed under a nitrogen gas flow and dark conditions to avoid the decomposition of pigments. Dryness of the sample should be ensured after grinding. If the sample is still wet, add silica-gel particles and continue to grind. Inadequate dehydration would lead to tailing of the spot of the pigments.

## 5.6 Photos of Macrophytes

At the end of this chapter, we display photos of macrophytes living around Japan. Photos of dried specimen would be more useful to compare, while those of living ones would be helpful to identify on site (Figs. 5.4 and 5.5).



*Ulva australis*



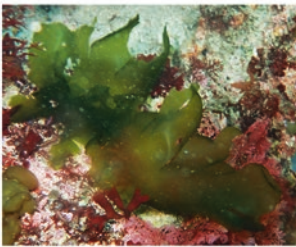
*Monostorama nitidum*



*Cladophora wrightiana*



*Codium lucasii*



*Umbraulva japonica*



*Microdictyon japonicum*



*Sargassum horneri*



*Eisenia bicyclis*

**Fig. 5.4** Photos of living macrophytes. Most of the photos were taken by Shigeki Wada at Shimoda, Shizuoka, Japan. The photo of *Sargassum horneri* was provided by Nicola Floch



*Ecklonia cava*



*Ishige foliacea*



*Myelophycus simplex*



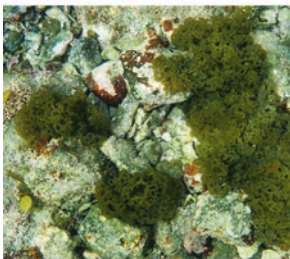
*Padina arborescens*



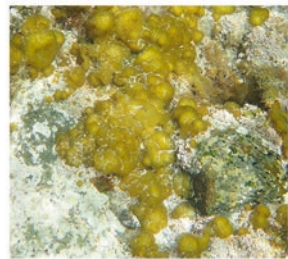
*Sargassum thunbergii*



*Sargassum ringgoldianum*



*Hydroclathrus clathratus*



*Leathesia difformis*

**Fig. 5.4** (continued)



*Sargassum macrocarpum*



*Petalonia binghamiae*



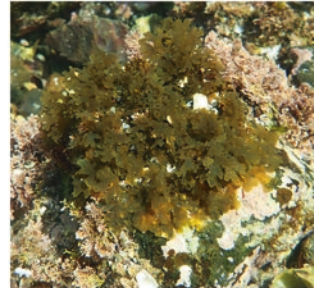
*Sargassum fusiforme*



*Colpomenia sinuosa*



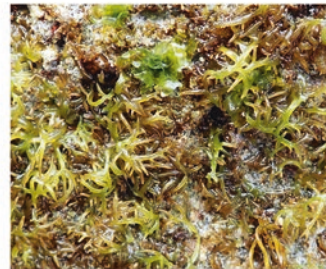
*Undaria pinnatifida*



*Dictyota dichotoma*



*Martensia jejuensis*



*Chondracanthus intermedius*

**Fig. 5.4** (continued)



*Asparagopsis taxiformis*



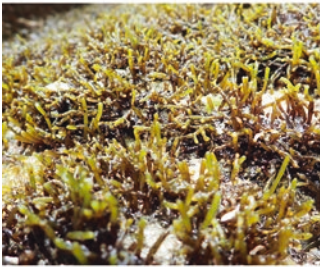
*Gracilaria textorii*



*Dermonema pulvinatum*



*Tricleocarpa jejuensis*



*Ahnfeltiopsis concinna*



*Delisea japonica*



*Meristotheca papulosa*



*Callophyllis adnata*

**Fig. 5.4** (continued)



*Gloiopeltis complanata*



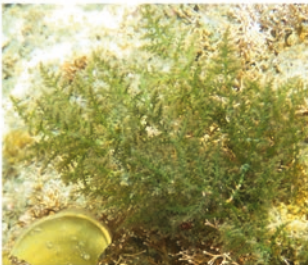
*Dudresnaya japonica*



*Gloiopeltis furcata*



*Gelidium elegans*



*Laurencia okamurae*



*Grateloupia asiatica*



*Mutimo cylindricus*



*Gelidium yoshidae*

**Fig. 5.4** (continued)



*Plocamium telfairiae*



*Amphiroa beauvoisii*

**Fig. 5.4** (continued)

*Ulva australis**Codium cylindricum**Dictyota dichotoma**Padina arborescens**Cladophora wrightiana**Monostroma nitidum**Myelophycus simplex**Sargassum ringgoldianum*

**Fig. 5.5** Photos of dried specimens. Preparation of dried specimens was done by Michiyo Noda, and photos taken by Hideki Abe. The locations where the algae were collected are listed as follows: *Ulva australis*: Ouno hama in Minami Izu; *Cladophora wrightiana*, *Martensia jejuensis*, and *Delisea japonica*: Toji in Shimoda; *Codium cylindricum*, *Desmarestia tabacoides*, *Meristotheca papulosa*, and *Ptilophora subcostata*: Shirahama in Shimoda; *Monostroma nitidum*: Oura in Shimoda; *Myelophycus simplex*, *Padina arborescens*, *Sargassum ringgoldianum*, *Sargassum fusiforme*, *Undaria pinnatifida*, *Gracilaria gigas*, *Pyropia dentata*, *Portieria japonica*, *Plocamium telfairiae*, and *Gelidium elegans*: Nabeta in Shimoda; *Scytosiphon lomentaria*, *Petalonia binghamiae*, and *Hypnea asiatica*: Nishiura in Numazu; *Mastocarpus yendoi*: Oziki in Kawazu; *Chondrus verrucosus* and *Fushitsunagia catenata*: Koina in Minami Izu





*Scytosiphon lomentaria*



*Desmarestia tabacoides*



*Petalonia binghamiae*



*Sargassum fusiforme*



*Undaria pinnatifida*



*Martensia jejuensis*



*Mastocarpus yendoii*



*Hypnea asiatica*

**Fig. 5.5** (continued)



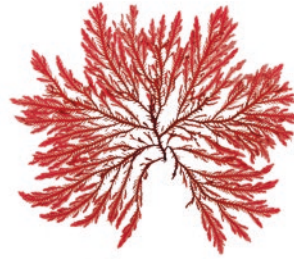
*Chondrus verrucosus*



*Gracilaria gigas*



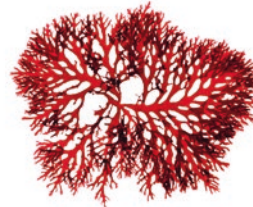
*Pyropia dentata*



*Delisea japonica*



*Meristotheca papulosa*



*Portieria japonica*



*Gloiopeltis complanata*



*Ptilophora subcostata*

**Fig. 5.5** (continued)



*Fushitsunagia catenata*



*Plocamium telfairiae*



*Gelidium elegans*

**Fig. 5.5** (continued)

---

## References

- Andersen, R. A. (1992). Diversity of eukaryotic algae. *Biodiversity and Conservation*, 1, 267–292. <https://doi.org/10.1007/BF00693765>
- Boström, C., & Bonsdorff, E. (1997). Community structure and spatial variation of benthic invertebrates associated with *Zostera marina* (L.) beds in the northern Baltic Sea. *Journal of Sea Research*, 37, 153–166. [https://doi.org/10.1016/S1385-1101\(96\)00007-X](https://doi.org/10.1016/S1385-1101(96)00007-X)
- Cavalier-Smith, T. (2016). Higher classification and phylogeny of Euglenozoa. *European Journal of Protistology*, 56, 250–276. <https://doi.org/10.1016/j.ejop.2016.09.003>
- Crossett, R. N., Drew, E. A., & Larkum, A. W. D. (1965). Chromatic adaptation in benthic marine algae. *Nature*, 207, 547–548. <https://doi.org/10.1038/207547a0>
- Davison, I. R., & Pearson, G. A. (1996). Stress tolerance in intertidal seaweeds. *Journal of Phycology*, 32, 197–211. <https://doi.org/10.1111/j.0022-3646.1996.00197.x>
- Dring, M. J. (1998). *The biology of marine plants*. Cambridge: Cambridge University Press.

- Kiang, N. Y., Siefert, J., & Govindjee, B. R. E. (2007). Spectral signatures of photosynthesis. I. Review of earth organisms. *Astrobiology*, 7, 222–251. <https://doi.org/10.1089/ast.2006.0105>
- Mann, K. H. (1973). Seaweeds: Their productivity and strategy for growth: The role of large marine algae in coastal productivity is far more important than has been suspected. *Science*, 182, 975–981. <https://doi.org/10.1126/science.182.4116.975>
- Ramus, J., Beale, S. I., Mauzerall, D., & Howard, K. L. (1976). Changes in photosynthetic pigment concentration in seaweeds as a function of water depth. *Marine Biology*, 37, 223–229. <https://doi.org/10.1007/BF00387607>
- Sasaki, H., Kataoka, H., Kamiya, M., & Kawai, H. (1999). Accumulation of sulfuric acid in dictyotales (phaeophyceae): Taxonomic distribution and ion chromatography of cell extracts. *Journal of Phycology*, 35, 732–739. <https://doi.org/10.1046/j.1529-8817.1999.3540732.x>
- Stephenson, T. A., & Stephenson, A. (1949). The universal features of zonation between tide-Marks on rocky coasts. *Journal of Ecology*, 37, 289. <https://doi.org/10.2307/2256610>
- Yokohama, Y., Tanaka, J., & Chihara, M. (1987). Productivity of the Ecklonia cava community in a bay of Izu peninsula on the Pacific Coast of Japan. *Botanical Magazine Tokyo*, 100, 129–141. <https://doi.org/10.1007/BF02488318>

Hiroaki Nakano

---

## Abstract

For most researchers and students who wish to study marine animals, the first critical step is the collection of the desired species from the sea. Since animals present a wide variety of characteristics (e.g., benthic or pelagic, microscopic or macroscopic, it is necessary to choose the appropriate method for each species. In this chapter, some general methods for collecting marine animals are explained, and pictures of marine animals that can be collected around Japan are presented.

---

## 6.1 How to Collect Rocky Shore Marine Animals

### Preparation

Wear a hat/cap to avoid heatstroke. Long-sleeved shirts and long trousers are preferable to avoid cuts from rocks. Use gloves to avoid injury to your hands. Wear non-slip shoes such as boots or marine shoes and avoid sandals that expose your feet.

Bring a drink to avoid dehydration and a first aid kit for your safety. A mobile phone or transceiver is useful for communication. A life vest may be desirable depending on the area. Check the tide time, evacuation site, and local weather beforehand.

Other things to take include metal scrapers, nets, tweezers, magnifying glass/loupe, buckets, paint/ink brush, and zipper storage bags for soft-bodied animals, sieves and hand shovel for animals living in the sand, sampling bottles for small animals, towels, waterproof notebook, camera, tide charts, and field guide.

---

H. Nakano (✉)

Shimoda Marine Research Center, University of Tsukuba, Shimoda, Shizuoka, Japan  
e-mail: [h.nakano@shimoda.tsukuba.ac.jp](mailto:h.nakano@shimoda.tsukuba.ac.jp)



**Fig. 6.1** Students collecting marine animals during a marine course at a rocky shore in Shimoda, Shizuoka, Japan

### Safety Rules

Do not go on your own or wander off from the group (Fig. 6.1).

Falling down may result in cuts from sharp rocks and shells, so do not run or jump on the rocky shore.

Use metal scrapers when searching for animals in holes and tide pools, you never know where animals with sharp spines/teeth or poisonous capabilities are hiding (e.g., moray eel, celtail catfish, waspfish, *Diadema setosum*, blue-ringed octopus, *Aglaophenia whiteleggei*, Portuguese man o' war).

If you see lightning or hear thunder, get out of the water immediately.

If there is a major earthquake or a tsunami alarm, evacuate immediately.

### General Tips

Share the collected animals within the group and do not collect too many specimens of the same species.

Do not leave buckets with animals inside out in the sun for prolonged periods; the seawater will become too hot for the animals to survive.

If you turn over or move a rock, please return it to the same position as before. A rock left upside down means a catastrophic environmental change for organisms living on the rock and they will likely die.

There are different restrictions (e.g., which species it is prohibited to collect, where animals can be collected) depending on the area, so it is important to follow these local rules. Caution is especially needed when collecting animals with commercial value, such as abalones, sazae (*Turbo sazae*), lobsters, and sea urchins.

## 6.2 How to Collect Marine Animals Using Dredges and Trawls

Collections using marine biological dredges and trawls are often performed at Japanese marine stations during marine courses, faunal surveys, or regular research activities (Fig. 6.2). They offer a qualitative (and sometimes semi-quantitative) view of the benthic animal species in the examined area.

A marine biological dredge/trawl is a net or box made of wire mesh, with an opening usually reinforced with a metal framing. The dredge/trawl is towed from a boat and dragged at or near the sea bottom with the opening in front to collect benthic and/or epibenthic animals. The animals and the bottom sediment enter the equipment through the opening and remain in the net, whereas seawater and sediment go through the mesh. The dredge/trawl is pulled up onto the boat by hand or winch and A-frame, and its contents are transferred into containers. The sediment is sieved if necessary (the sieve size depends on the intended animal) and the collected animals are sorted subsequently. The sieving and sorting can be performed either on the boat or after returning to the marine station. During the summer, it might be necessary to cool the collected material with ice packs to keep the animals alive while on the boat.

### Safety Rules

Follow the instructions of the staff on the research vessel.

Always wear life vests onboard, and also helmets near A-frames, winches, and wires.

Wear non-slip shoes, such as boots or marine shoes, and avoid sandals that expose your feet.

Stay away from A-frames, winches, wires, and ropes during operation.

Stinging animals may have been caught, so do not put your bare hands in the equipment or containers with the collected contents inside.

---

## 6.3 Other Ways to Collect Marine Animals

The following methods are not as frequently employed as the above two methods during marine biological courses. But they can offer a wide variety of species that cannot be collected with the above methods.

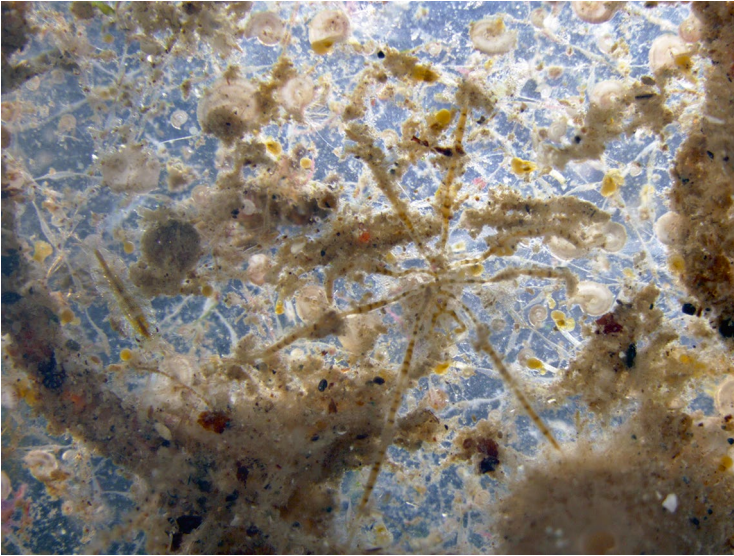
### Collection of Sessile Animals

This can be performed by studying rocks and seaweed collected from rocky shores, but sessile organisms are often overlooked during collection. This can also be achieved by studying ships' hulls or buoys that have been in seawater for a prolonged time. Another method is to place substrata, such as glass/plastic plates or glass slides, in the seawater for a certain amount of time (it is important to prevent them from being broken or carried away by the waves), retrieve the substrata, and investigate them under a stereomicroscope (Fig. 6.3). This method enables

**Fig. 6.2** Different types of dredges used at Japanese marine stations. The dredge in the top picture is sometimes called a benthic sled







**Fig. 6.3** A glass plate retrieved after 2 months in seawater. Various animals such as cnidarians, annelids, and arthropods are present

quantitative and qualitative comparisons of different conditions, such as the substratum (glass and plastic plates), duration in seawater, depth, and orientation (horizontal and vertical). Sponges, hydrozoans, bryozoans, entoprocts, fanworms, barnacles, and ascidians can be observed. At the same time, creeping animals such as placozoans, flatworms, xenacoelomorphs, and gastropods may be found.

### **Meiofauna Collections**

Meiofauna refers to animals roughly between 45  $\mu\text{m}$  and 1 mm in size. Therefore, it is a group classified based solely on size and is not a taxonomically valid group. They can be found from sandy beaches to the deep seafloor, usually living between grains of the sediment. The sediment is collected using hand shovels at a beach or shore, or by biological dredges, grab samplers (e.g., Ekman-Birge, Smith McIntyre, and Van Veen), and core samplers from the seafloor. The animals are separated from the sediment by osmotic shock using freshwater, various anesthetics or fixatives, or frozen seawater, and filtered out through a 45  $\mu\text{m}$  sieve. Due to their small size, collecting and identifying the animals are performed under microscopes.

### **Collections from Sandy Beaches, Mudflats, Salt Marshes, and Mangroves**

This can be performed in a similar manner to rocky shore collections, but specific equipment for each environment may be necessary. Various species adapted to each environment can be expected.

### **Fishing**

This can be performed using spears, nets, or rods and hooks, yielding many species of fish and invertebrates.

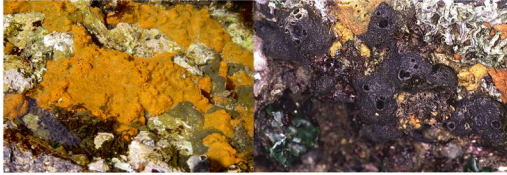
### **Swimming and Diving**

These methods are not only effective for collecting marine animals, but also offer the invaluable experience of observing and photographing marine animals in their natural habitat. The use of equipment such as snorkel or SCUBA extends the time in water, and with recent advances in equipment, SCUBA diving is possible to depths of more than 20 m. However, these methods can be dangerous and should be performed with care, and never alone. Be sure to avoid drowning, being lost at sea, hypothermia, venomous or stinging animals, biting animals such as sharks, and the sharp edges of rocks and corals. When SCUBA diving, be careful of decompression sickness and lack of oxygen. For scuba diving, a diving certification card, 'C-card', is necessary, and certain levels may be needed according to the depth or operation. In many Japanese marine stations, insurance, as well as a diver's license ('sensui-shi', authorized by the Ministry of Health, Labour and Welfare) is required, so please first consult the institution where you plan to dive.

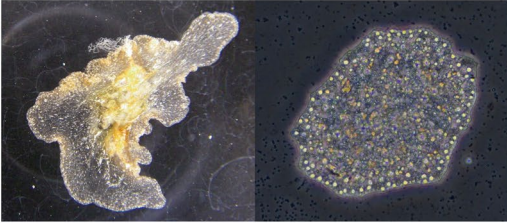
---

## **6.4 Marine Animals Collected Around Japan**

Japan is a long and narrow country with a wide variety of climates, from Hokkaido in the north to Okinawa in the south. The fauna in each region is unique, and it is impossible to show here all of the species that can be collected around the country. In Fig. 6.4, species that can be collected or seen during marine courses at Shimoda Marine Research Center, University of Tsukuba, located near the middle of Japan, are shown. For general taxonomic reference, some of the recommended picture books are available: Nishimura (1992, 1995) and Okada et al. (2004a, b, c).



**Phylum: Porifera.** Left: *Halichondria japonica*. Right: *Halichondria okadai*



Left: **Phylum: Ctenophora.** *Coeloplana willeyi*. Right: **Phylum: Placozoa.** *Trichoplax* sp.

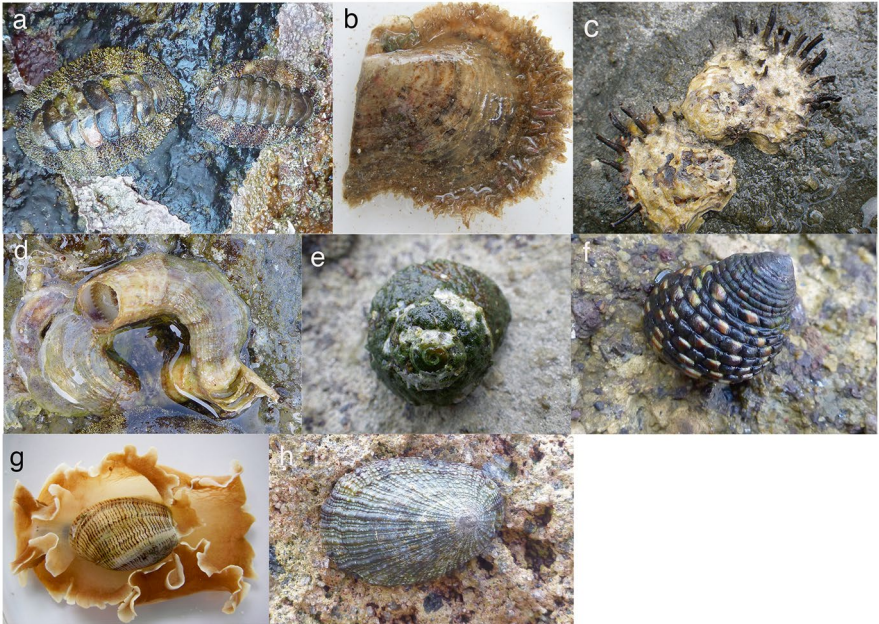


**Phylum: Cnidaria.** Left top: *Anthopleura asiatica*. Left bottom: *Dofleinia armata*. Right: *Physalia physalis*

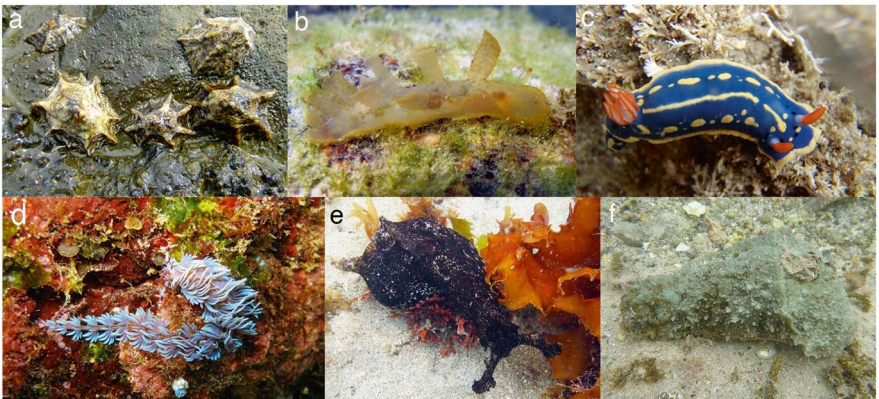


**Phylum: Platyhelminthes.** Left: *Pseudobiceros gratus*. Right: *Pseudostylochus obscurus*.

**Fig. 6.4** Marine animals collected around Japan



**Phylum: Mollusca.** a: *Liolophura japonica*. b: *Pinctada imbricate*.  
 c: *Saccostrea kegaki*. d: *Thylacodes adamsii*.  
 e: *Lunella correensis*. f: *Monodonta confuse*.  
 g: *Hydatina physis*. h: *Cellana toreuma*

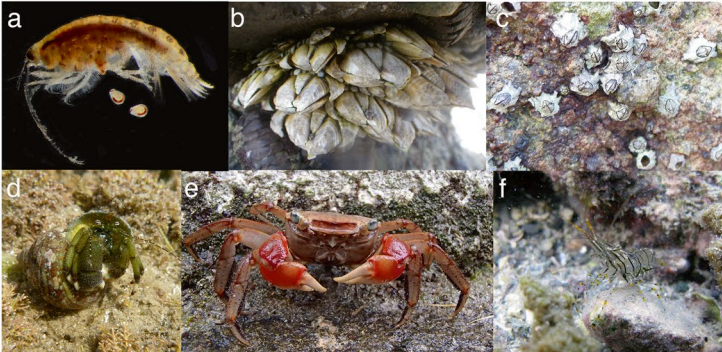


**Phylum: Mollusca (continued).** a: *Patelloida saccharina*. b: *Melibe viridis*.  
 c: *Hypselodoris festiva*. d: *Pteraeolidia semperi*.  
 e: *Aplysia kurodai*. f: *Dolabella auricularia*

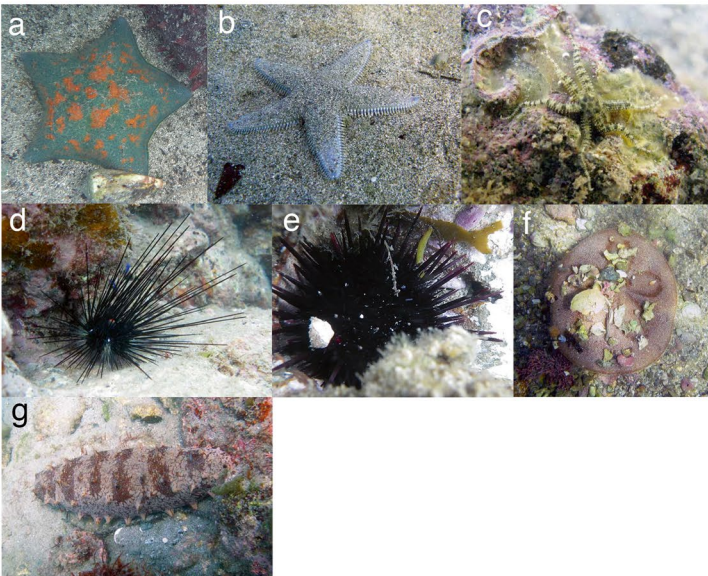
**Fig. 6.4** (continued)



Phylum: Annelida. a: *Sabellastarte* sp. b: *Acrocirrus validus*. c: Tube clusters of *Spirobranchus kraussii*

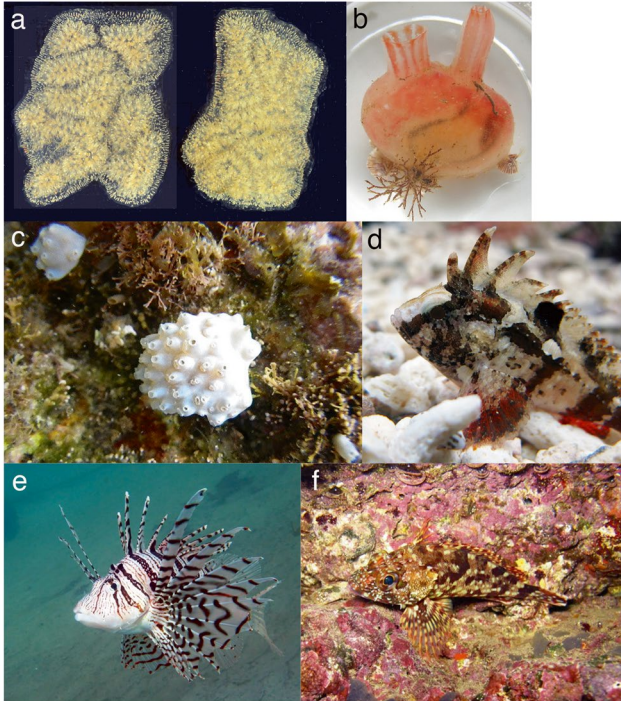


Phylum: Arthropoda. a: *Byblis japonicus*. b: *Capitulum mitella*. c: *Chthamalus challenger*. d: *Pagurus filholi*. e: *Chiromantes haematocheir*. f: *Palaemon paicificus*



Phylum: Echinodermata. a: *Patiria pectinifera*. b: *Astropecten scoparius*. c: *Ophiactis savignyi*. d: *Diadema setosum*. e: *Heliocidaris crassisпина* f: *Clypeaster japonicus*. g: *Apostichopus japonicus*

Fig. 6.4 (continued)



**Phylum: Chordata.** a: *Botryllus scalaris*. b: *Herdmania momus*. c: *Polycitor proliferus*. d: *Paracentropogon rubripinnis*. e: *Pterois lunulate*. f: *Sebastiscus marmoratus*.

**Fig. 6.4** (continued)

## References

- Nishimura, S. (1992). *Guide to seashore animals of Japan with color pictures and keys I*. Osaka: Hoikusha.
- Nishimura, S. (1995). *Guide to seashore animals of Japan with color pictures and keys II*. Osaka: Hoikusha.
- Okada, Y., Uchida, S., & Uchida, R. (2004a). *New illustrated encyclopedia of the fauna of Japan I*. Tokyo: Hokuryukan.
- Okada, Y., Uchida, S., & Uchida, R. (2004b). *New illustrated encyclopedia of the fauna of Japan II*. Tokyo: Hokuryukan.
- Okada, Y., Uchida, S., & Uchida, R. (2004c). *New illustrated encyclopedia of the fauna of Japan III*. Tokyo: Hokuryukan.



# Distribution of Organisms on the Seashore

# 7

Koetsu Kon

## Abstract

Marine organisms are found on various types of seashores. The shore features often change gradually according to their degree of exposure to wave action. With decreasing exposure, the substratum changes from rocks in the most exposed/open regions to silts/clays in very sheltered conditions. Some organisms, called ecosystem engineers or foundation species, form biogenic habitats such as mussel beds, oyster reefs, salt marshes, mangrove forests, seagrass meadows, kelp forests, and coral reefs. Marine organisms have latitudinal limits. The climate in Japan ranges from sub-arctic to subtropical, and includes most temperate climatic zones; thus, the distribution of marine organisms depends on the climatic zones present. Biogenic habitats are also influenced by climate; for instance, intertidal salt marsh in a temperate zone is normally replaced by mangrove forest in a subtropical region. Likewise, kelp forest in sub-arctic/temperate zones is replaced by coral reefs in tropical regions. This section briefly describes typical seashore habitats for marine organisms, with a focus on rocky/sediment shores and biogenic habitats, such as kelp forests, salt marshes, mangrove forests, seagrass beds, and coral reefs.

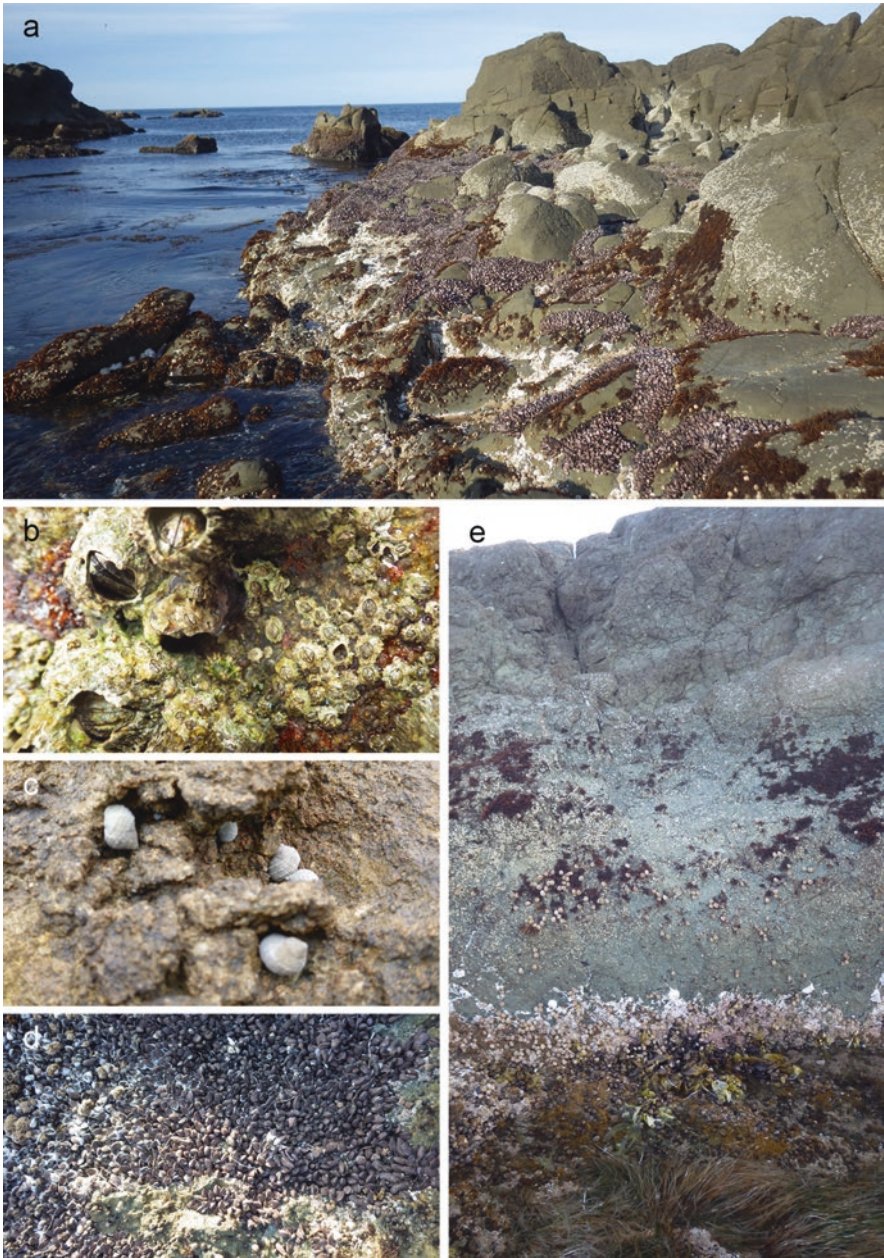
## 7.1 Rocky Shore

Rocky shores are found on most wave-exposed coastlines where rock predominates (Fig. 7.1). On these shores, solid rock provides an attachment surface for sessile organisms, where epibenthic macrophytes and macrofauna encrust the rock surface, along with mobile fauna. Crevasses or dimples in the rocks create a

---

K. Kon (✉)

Shimoda Marine Research Center, University of Tsukuba, Shimoda, Shizuoka, Japan  
e-mail: [kon@shimoda.tsukuba.ac.jp](mailto:kon@shimoda.tsukuba.ac.jp)



**Fig. 7.1** A rocky shore at Usujiri, Hokkaido, Japan (a). Dominant sessile organisms *Tetraclita japonica* and *Chthamalus challengerii* (b). Utilization of rock dimple by *Nodilittorina radiata* (c). Mussel beds providing habitats for cryptic animals (d). Zonation pattern of an intertidal rocky shore (e)



more complex structure, and this creates a three-dimensional habitat for cryptic species. Mussel beds or oyster reefs, which sometimes occupy rock surfaces, also provide complex interstitial spaces between their shells for smaller organisms.

Generally, in intertidal areas, clear zonation patterns are found, showing an obvious vertical distribution pattern of organisms (Rafaelii and Hawkins 1999). According to the universal classification scheme of zonation, the shore is divided into three major zones: the high-shore zone, called the supralittoral fringe; a broad mid-shore area, called the midlittoral zone; and a low-shore zone, referred to as the infralittoral fringe.

## 7.2 Kelp Forest

Wave-exposed rocky subtidal shores are often occupied by dense macroalga vegetation (Fig. 7.2). In particular, brown seaweeds, in the order Laminariales, form kelp forests throughout temperate and sub-arctic zones. In Japan, most shore habitats are temperate, and thus kelp forests are common along the coast. These



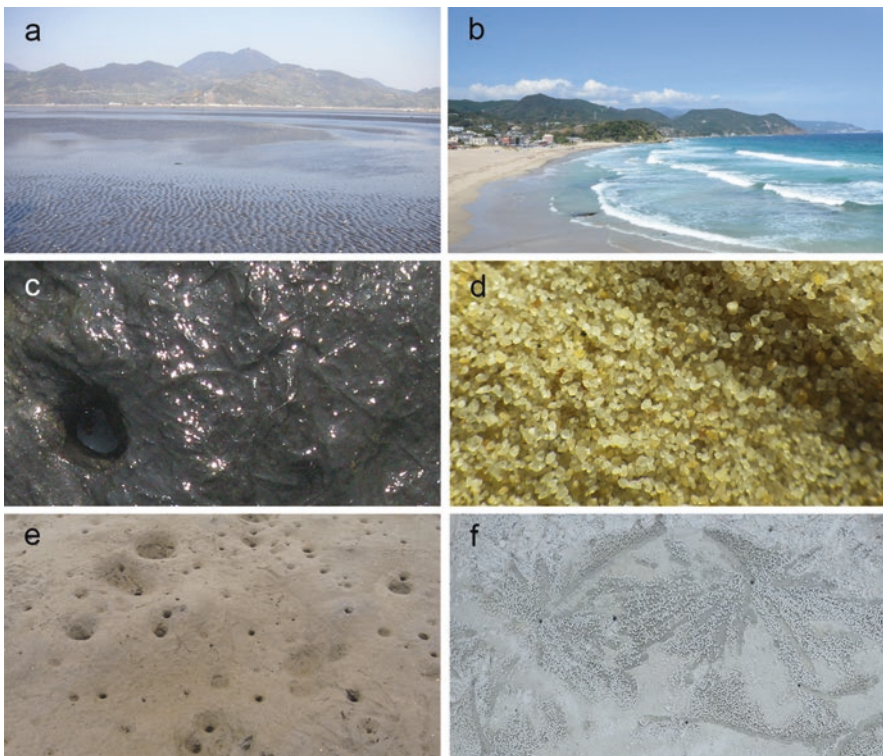
**Fig. 7.2** A kelp forest at Oura Bay, Izu Peninsula, Japan (a). Animals utilize the seaweed body as refuge site (b), or habitat substratum (c)

ecosystems have high biological production (Mann 1973), which in turn provide many ecosystem services.

Various marine organisms are found in kelp forests. Seaweeds provide habitat for smaller sessile organisms such as epiphytic diatoms, polyzoans, hydrozoans, and colonial ascidians. Larger mobile fauna, including gastropods and crustaceans, also utilize kelp. Kelp forests provide a complex three-dimensional environment, which functions as a refuge from predators. Kelp also acts as a feeding ground for herbivorous gastropods, echinoids, and fish. Consumption by sea urchins sometimes removes large parts of kelp forests, while consumption by other gastropods and fish has little effect.

### 7.3 Sediment Shore

Sediment shores are coastal shorelines where sand/mud accumulates (Fig. 7.3). These shores are located in sheltered/closed regions; nevertheless, the degree of wave exposure, which characterizes the beach features, can differ among shores.



**Fig. 7.3** A sheltered shore (mud flat) at Shirakawa estuary in Ariake Bay (a), and an exposed shore (sandy beach) at Yumigahama in Izu Peninsula, Japan (b). Substratum components of shores (c, mud flat; d, sandy beach). Burrows of infaunal species on the sediment surface (e, mud flat; f, sandy beach)

Wave-exposed beaches accumulate larger particles (sand) and are referred to as sandy beaches. The most sheltered/closed beaches, called mud flats, consist of smaller particles (silt/clay).

Organisms are three-dimensionally distributed above and below the sediment on sediment shores. Floral distribution is limited to the surface and/or the thin top-layer and is dominated by benthic microalgae. In contrast, most faunal species are distributed within the substratum, and there are dominant macrofaunal and meiofaunal groups. Generally, the species richness, abundance, and biomass of the macrofaunal community increase from exposed to sheltered shores (Allen and Moore 1987), because most species are unable to cope with the highly unstable habitats caused by wave disturbance.

## 7.4 Salt Marsh

Intertidal soft sediment is sometimes occupied by salt-tolerant grasses. In the temperate regions of Japan, salt marshes are mainly constituted of reed (*Phragmites australis*) colonies, which are commonly found in brackish areas (Fig. 7.4).



**Fig. 7.4** A salt marsh constituted by common reed (*Phragmites australis*) colonies at Shinhamako, Tokyo Bay, Japan (a). Epiphytes on common reed stems (b). A sesamid crab utilizing common reed as a food source and refuge site (c)

In salt marshes, reed grasses provide a physical structure above the ground (i.e., stems and blades), which is composed of soft sediment. The organisms in this habitat are distributed three-dimensionally from the sediment to the aboveground macrophyte bodies. The grass stems/blades harbor a large number of epiphytic microorganisms (e.g., microalgae). Microorganisms, as well as the detritus from reed grass, support abundant primary consumers, including polychaetes, amphipods, and decapods. Furthermore, the complex structure of reed grass (i.e., dense stems and leaves) provides refuge from predators for various epifaunal species, while underground grass roots support the burrow constructions of some infaunal species (Bertness and Miller 1984).

## 7.5 Mangrove Forest

In subtropical and tropical zones, intertidal soft sediments are often occupied by mangroves with salt-tolerant trees (Fig. 7.5). Mangrove forests comprise 54–73 plant species worldwide. In Japanese mangroves there are 14 plant species, including some that are non-native (Tropical Coastal Ecosystems Portal 2018). The mangroves in Japan



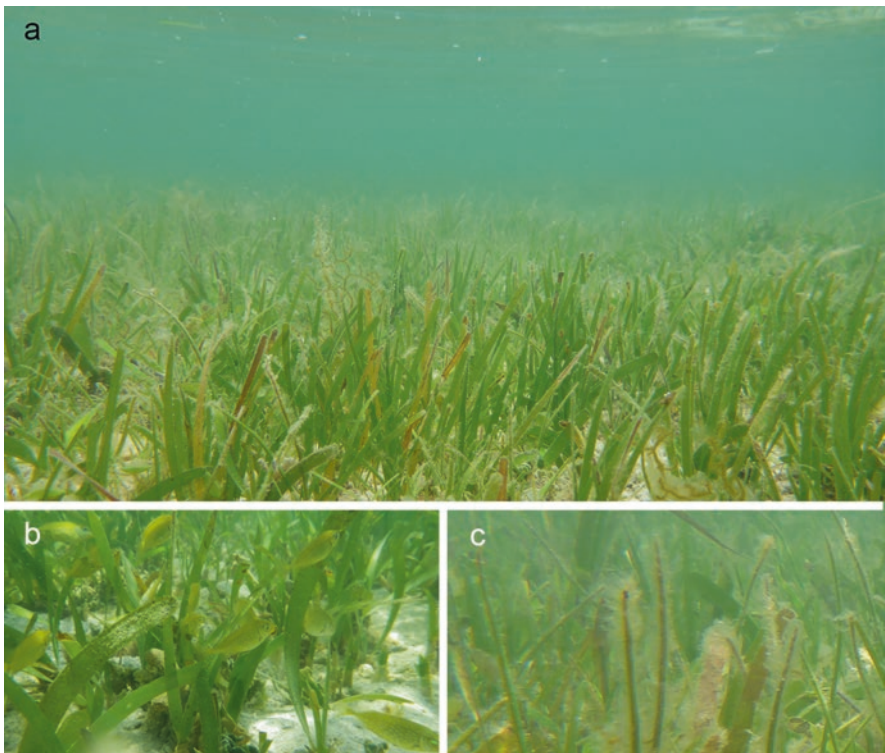
**Fig. 7.5** A mangrove forest in Funaura Bay, Iriomote Island, Okinawa, Japan (a). Mangrove roots provide a home for various benthic invertebrates (b). *Terebralia palustris* feeding on mangrove leaf litter (c)

are the most northerly of the Indo-West Pacific biogeographic region, and accordingly, their distribution is limited to small areas in the south of the country.

Mangrove forests provide unique habitats for both aquatic and terrestrial organisms and achieve a high biological production. Mangrove trees are the largest source of primary production, with macro/microalgae contributing a minor proportion. Various invertebrates (such as polychaetes, bivalves, gastropods, and crustaceans) are distributed widely, from the underground sediment to aboveground macrophyte bodies. Invertebrates benefit from the increased food availability, shelter from predators, physical defense from harsh environments, and habitat provided by mangroves (Nagelkerken et al. 2008).

## 7.6 Seagrass Bed

Seagrasses are flowering plants (angiosperms) which grow in marine and brackish areas in upper subtidal zones. Seagrasses can develop dense vegetation, referred to as seagrass beds or seagrass meadows. Seagrass beds are found throughout the coast of Japan; *Zostera* spp. are dominant in temperate zones, while various species are found in subtropical zones (Fig. 7.6).



**Fig. 7.6** A seagrass bed in Nagura Bay, Ishigaki Island, Okinawa, Japan (a). Seagrasses function as nursery grounds and support an abundance of juvenile fish (b: photo by Yamada H). Dense epiphytes on seagrass leaves (c)

Seagrass beds harbor various marine organisms; for example, juvenile and adult fish, crustaceans, and gastropods. Epiphytic microalgae are common above the substratum, while polychaetes, bivalves, and nematodes burrow into the sediment. In particular, seagrass meadows support invertebrate larvae and juvenile fish by functioning as nursery grounds. These species stay in seagrass beds during their early life stages, and then move to coral reefs and other ecosystems as they mature. Seagrasses provide refuge from predators, and their leaves allow attachment of epiphytic microorganisms.

## 7.7 Coral Reef

Coral reefs develop on subtidal shores, normally at greater depths than seagrass beds, in subtropical and tropical zones. Reefs consist of hermatypic coral colonies that have hard carbonate exoskeletons, and their distribution is limited to small areas in southern Japan (Fig. 7.7). However, small patches of coral can be found up to the warm temperate zone (e.g., Boso Peninsula).



**Fig. 7.7** A coral reef at Sesoko, Okinawa, Japan (a). Corals form a fringing reef along the coastline (b). The complex structure of coral branches provides a habitat for various marine organisms (c)

Shallow coral reefs form one of the most diverse ecosystems in the world; they provide a habitat for at least 25% of all marine species (Spalding and Grenfell 1997), including sea turtles, fish, cephalopods, gastropods, bivalves, polychaetes, crustaceans, echinoderms, sponges, tunicates, and other cnidarians. Faunal species are widely distributed around the coral exoskeleton structures; they use the interstitial spaces among coral branches as refuge sites, utilize the hard exoskeletons as attachment substrates, and forage around the structures. Although coral reefs sustain a high primary production to support high faunal consumption, conspicuous plants are rare due to significant grazing pressure.

---

## References

- Allen, P. L., & Moore, J. J. (1987). Invertebrate macrofauna as potential indicators of sandy beach stability. *Estuarine, Coastal and Shelf Science*, 24(1), 109–125.
- Bertness, M. D., & Miller, T. (1984). The distribution and dynamics of *Uca pugnax* (Smith) burrows in a New England salt marsh. *Journal of Experimental Marine Biology and Ecology*, 83(3), 211–237.
- Mann, K. H. (1973). Seaweeds: Their productivity and strategy for growth. *Science*, 182(4116), 975–981.
- Nagelkerken, I., Blaber, S. J. M., Bouillon, S., Green, P., Haywoodf, M., Kirton, L. G., et al. (2008). The habitat function of mangroves for terrestrial and marine fauna: A review. *Aquatic Botany*, 89(2), 155–185.
- Tropical Coastal Ecosystems Portal. (2018). *Lists of Mangrove flora*. Retrieved May 10, 2019, from [http://www.nies.go.jp/TroCEP/mangrove\\_flora/index.html](http://www.nies.go.jp/TroCEP/mangrove_flora/index.html)
- Rafaelii, D., & Hawkins, S. (1999). *Intertidal ecology* (2nd ed.). London: Kluwer.
- Spalding, M. D., & Grenfell, A. M. (1997). New estimates of global and regional coral reef area. *Coral Reefs*, 16(4), 225–230.

---

**Part II**

**Cell and Developmental Biology**





Kazuo Inaba

## Abstract

Life forms originated from the sea, and it is thought that they probably came from deep in the ocean at hydrothermal vents. Life forms started from the generation of small organic compounds, such as amino acids, and then self-replicable nucleic acid, RNA, until finally DNA emerged. The most critical event for life was the compartmentalization of these replicable units by lipid membrane. Starting from these protocells, cells underwent functional evolution; symbiosis, and multicellularization. Marine organisms became diversified, as seen in the Cambrian explosion, but have retained the basic cellular mechanisms from ancient unicellular organisms into more complicated multicellular organisms.

Many of the basic mechanisms for cellular activity have been studied using marine organisms. The concept of fertilization was first established using sea urchins in the late 1800s by pioneer scientists, such as K. Fon Baer, Oskar Hertwig, and Hermann Fol, and later in the early 1990s by Jacques Loeb and Frank Lillie. The exocytosis of a vesicle in sperm prior to fertilization, the acrosome reaction, was found in sea urchins by Jean Clark Dan (1952). Later a protein essential for the interaction between sperm and egg, named bindin, was identified by Vic Vacquier and Gary Moy (1977) in sea urchin sperm. One of the important cytoskeletal elements that constitutes microtubules, tubulin, was found and named by Hideo Mohri (1968) using sea urchin sperm. Another electrophysiological mechanism for the events required after fertilization was also clarified using marine invertebrates. It is relatively easy to handle and observe the sperm and eggs from marine invertebrates,

---

K. Inaba (✉)

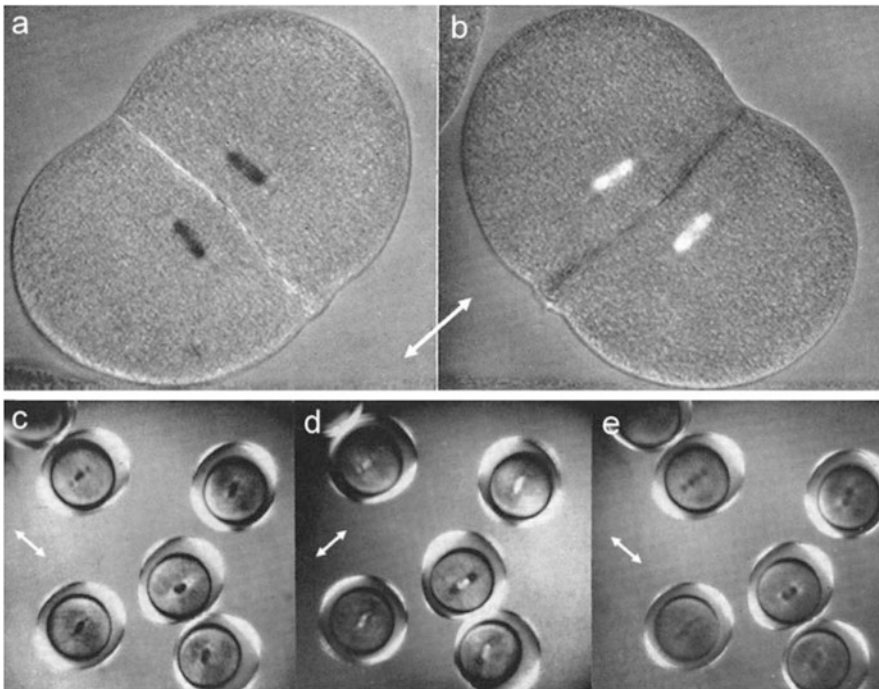
Shimoda Marine Research Center, University of Tsukuba, Shimoda, Shizuoka, Japan  
e-mail: [kinaba@shimoda.tsukuba.ac.jp](mailto:kinaba@shimoda.tsukuba.ac.jp)

© Springer Nature Singapore Pte Ltd. 2020

K. Inaba, J. M. Hall-Spencer (eds.), *Japanese Marine Life*,  
[https://doi.org/10.1007/978-981-15-1326-8\\_8](https://doi.org/10.1007/978-981-15-1326-8_8)

which gives a good opportunity for students to observe these gametes and the moment of fertilization in real time (see Sect. 3.2).

Egg development of marine invertebrates has provided several experimental advantages for understanding the mechanism of cell division and differentiation. This is mostly from the advantages that they are transparent enough to be observed under a light microscope in some species and that they undergo cell division synchronously. Other advantages are that they show different egg cleavages based on the size and position of dividing cells (blastomeres) and their cell fates. As for the cell division or mitosis, eggs of sea urchin, jelly fish, and some other eggs of marine invertebrate can easily provide sufficient experimental materials for studying intracellular structures and their behaviors. Some pioneer studies were done using the eggs of marine invertebrates, including those by Katsuma Dan, Shinya Inoue (Fig. 8.1), and Yukio Hiramoto. Taking advantages of the synchronicity for cell division, a key protein controlling cell cycle, cyclin, was found in sea urchin and surf



**Fig. 8.1** Visualization of a 'live' mitotic spindle in marine invertebrates. After the initial report on the live observation of mitotic spindle in sea urchin eggs by W. J. Schmidt (1939) with a polarizing microscope, Shinya Inoue visualized the birefringent spindle and aster of jellyfish (a, b) and sand dollar (c–e) eggs much clearer with his handmade polarizing microscope ('Shinya-Scope') at Misaki Marine Biological Station (Inoué and Dan 1951; Inoué 2016). Shinya's spirits are inherited to many cell biologists including those in MBL and a Japanese scientist Hidemi Sato, who continued his work at Shinya's lab at Sugashima Marine Biological Laboratory, Nagoya University, Japan. The figure was reproduced from Inoué (2008) with permission

clam eggs by Tim Hunt and his colleagues (Evans et al. 1983), by which a thousand embryo with synchronous cell division was obtained and used for biochemical analysis of the cell cycle. It is worth noting that Tim found cyclin during a physiology course at the Marine Biological Laboratory at Woods Hole. Another important piece of work related to the discovery of cyclin was the finding of maturation-promoting factor (MPF) in starfish oocyte. These studies were led by Haruo Kanatani who found MPF from a series of studies on the hormonal regulation of oocyte maturation in starfish (see Chap. 9).

Marine organisms have also been contributing to our understanding of the principles behind developmental biology, in particular through the study of marine invertebrates (Chap. 10). Observation of the development of marine animals first started during a course aimed at pursuing Darwinism, held at the Stazione Zoologica Napoli (SZN), Italy, which was founded by Anton Dohrn. SZN is where many of the important first observations of development in marine invertebrates were carried out. The descriptions of unique development in some marine invertebrates also include works by Japanese scientists, including Naohide Yatsu (nemertean) and Taku Komai (ctenophores). The fashion of research then moved towards experimental biology in order to understand the mechanisms behind how one egg differentiates into several tissues and organs, and then develops into the larva and adult. Key research in the early history of developmental biology includes the development of separated blastomeres in ascidians (Laurent Chabry), sea urchins (Hans Driesch; Sven Hörstadius), ctenophores (Driesch and Tomas Hunt Morgan), and tusk shells (Edmund B. Wilson), and tracing cell lineage and fates in ascidians (Edwin Conklin) and sea urchins (Sven Hörstadius). These pioneer works in developmental biology were mostly carried out in marine stations. After the initial studies on the molecular embryology of sea urchins by Alberto Monroy, scientists are now trying to understand the developmental mechanisms of marine invertebrates at the level of gene regulation, as seen in the later accomplishments of a series of studies lead by Nori Satoh (ascidians) and Eric Davidson (sea urchins).

Comparative studies demonstrate that the embryos in the early stages of development show similar morphology in closely related species, as in the theory of recapitulation by Ernst Haeckel, and therefore comparative embryology gives an important insight into phylogenetics (Chap. 13). Although it is not always easy to describe the developmental process in some marine organisms (due to the difficulties in collection, handling, and culture), the description of the developmental process is essential for a basic understanding of the activity and ecological strategies of marine organisms, as well as for basic information in the fisheries sciences. For example, fishes were the first form of vertebrate and their developments are deeply connected to the evolution of vertebrates. Model organisms, such as zebrafish and medaka, have been contributing much to the understanding of vertebrate development through the use of both transgenic fish and natural or gene-manipulated mutants based on their genetic information. The latter was pioneered by artificial insemination and developmental description of a fresh water fish medaka by Tokio Yamamoto (1939). In fisheries science, the handling of gametes, artificial fertilization and cultivation are all indispensable techniques for aquaculture,

cryopreservation of gametes and embryos, and species conservation. Many fishes have unique sexual behavior, reproductive strategies, and environmental adaptation. The precise observation and description of their development is essential for the identification of species at embryonic and larval stages in field samples, and ultimately leads to a greater understanding of fish ecology (Chap. 11).

Another indispensable example for the developmental biology of marine organisms is the seaweeds. Seaweeds (macroalgae) have traditionally been treated as marine plants, but most are phylogenetically distinct from land plants (see Chaps. 4 and 5). Seaweeds are indispensable in the maintenance of marine ecosystem functioning due to their production of oxygen, carbon circulation, and provision of the habitat for other many marine organisms, particularly for larvae lifestages. As first demonstrated by Camille Sauvageau (1915) in *Saccorhiza bulbosa* and later in some Japanese species of *Laminariales* by Tiyoiti Kanda (1936), algae show a unique life cycle including the production of sporophytes and gametophytes into the sea, which is the basis for the classification of marine algae. Needless to say, they remain an indispensable aspect of Japanese food culture since the olden days. Biologically they provide a unique clue for studying the evolutionary transition of reproduction from isogamy to oogamy (Chap. 12).

For practical field courses in the field of marine cellular and developmental biology, you will be able to experience a kind of small world within an organism where several dramatic cellular changes can rapidly occur. These changes are rather fast, when compared to those in marine ecosystem, but nonetheless will have direct relevant for all the marine organisms in the sea, and are essential for determining their roles and lives within the ocean. When observing such cellular phenomena, the scientist can either focus on the much smaller molecular world and how underlying molecules drive these changes, or into the much wider ecosystem-level and consider how those changes support and underpin the huge and diverse ocean itself.

---

## References

- Inoué, S. (2016). *Pathways of a cell biologist: Through yet another eye*. Singapore: Springer.
- Inoué, S., & Dan, K. (1951). Birefringence of the dividing cell. *Journal of Morphology*, 89, 423–456.
- Dan, J. C. (1952). Studies on the acrosome I. Reaction to egg water and other stimuli. *Biol Bull*, 103, 54–66.
- Evans, T., Rosenthal, E. T., Youngblom, J., Distel, D., & Hunt, T. (1983). Cyclin: a protein specified by maternal mRNA in sea urchin eggs that is destroyed at each cleavage division. *Cell*, 33, 389–396.
- Kanda, T. (1936). On the gametophytes of some Japanese species of Laminariales. *Scientific papers of the Institute of Algological Research, Faculty of Science, Hokkaido Imperial University*, 2, 155–193.
- Mohri, H. (1968). Amino-acid composition of “tubulin” constituting microtubules of sperm flagella. *Nature*, 217, 1053–1054.
- Sauvageau, C. (1915). Sur le développement et la biologie d’une Laminaire (*Saccorhiza bulbosa*). *Comptes rendus de l’Académie des Sciences [Paris]*, 160, 445–448.

- 
- Schmidt, W. J. (1939). Doppelbrechung der Kernspindel und Zugfasertheorie der Chromosomenbewegung. *Chromosoma*, 1, 253–264.
- Vacquier, V., & Moy, G. (1977). Isolation of bindin: The protein responsible for adhesion of sperm to sea urchin eggs. *Proceedings of the National Academy of Sciences of the United States of America*, 74, 2456–2460.
- Yamamoto, T. (1939). Changes of the cortical layer of the egg of *Oryzias latipes* at the time of fertilization. *Proceedings of the Imperial Academy (Tokyo)*, 15, 269–271.



# Gametes and Fertilization

# 9

Kazuo Inaba, Hitoshi Sawada, Manabu Yoshida,  
Kogiku Shiba, and Maki Shirae-Kurabayashi

## Abstract

Reproduction underpins the life cycles, population dynamics, and ecology of marine organisms which have a wide variety of strategies, including sexual and asexual, gonochorism and hermaphroditism, as well as internal or external fertilization. It is often easy to collect a large quantity of gametes from species with external fertilization. In some species, such as many Echinodermata, female gametes (oocytes and eggs) are semitransparent, which makes it possible to observe changes in intracellular structures during fertilization. For these reasons, gametes from marine organisms have contributed to the general knowledge of biology, e.g., the first observation of sperm penetration into an egg and studies on the motile machinery of flagella (microtubules and dyneins), hormonal regulation of spawning in marine invertebrates, and oocyte maturation and cell cycles. Sexual maturation in marine organisms varies among species and their habitats; however, most Japanese species are seasonal and spawn once a year. For experiments using gametes and their fertilization, it is important to know the time of the spawning or copulation. In this chapter, we focus on the gametes and fertilization of marine species, especially marine invertebrates. Reproduction of marine algae is described in Chap. 12.

**Electronic supplementary material** The online version of this chapter ([https://doi.org/10.1007/978-981-15-1326-8\\_9](https://doi.org/10.1007/978-981-15-1326-8_9)) contains supplementary material, which is available to authorized users.

K. Inaba (✉) · K. Shiba  
Shimoda Marine Research Center, University of Tsukuba, Shimoda, Shizuoka, Japan  
e-mail: [kinaba@shimoda.tsukuba.ac.jp](mailto:kinaba@shimoda.tsukuba.ac.jp)

H. Sawada · M. Shirae-Kurabayashi  
Sugashima Marine Biological Laboratory, Nagoya University, Toba, Mie, Japan

M. Yoshida  
Misaki Marine Biological Station, University of Tokyo, Miura, Kanagawa, Japan

## 9.1 Gonad Development

The anatomy and position of gonads are shown for a range of marine organisms in Fig. 9.1. Gonads usually form after about 1 year of age in most marine animals, but the time to full sexual maturation differs widely. Some ascidians, such as *Ciona* spp., begin to bear gametes 2–3 months after metamorphosis and settlement, but sea urchins undergo sexual maturation at 2–3 years of age or older. Some fish change gender; for example, Japanese black seabream (*Acanthopagrus schlegelii*) are male at 1–3 years old, but become female at 4 years old. The timing of spawning is generally regulated by several external and internal cues, such as light, tide, hormones, and neuropeptides.

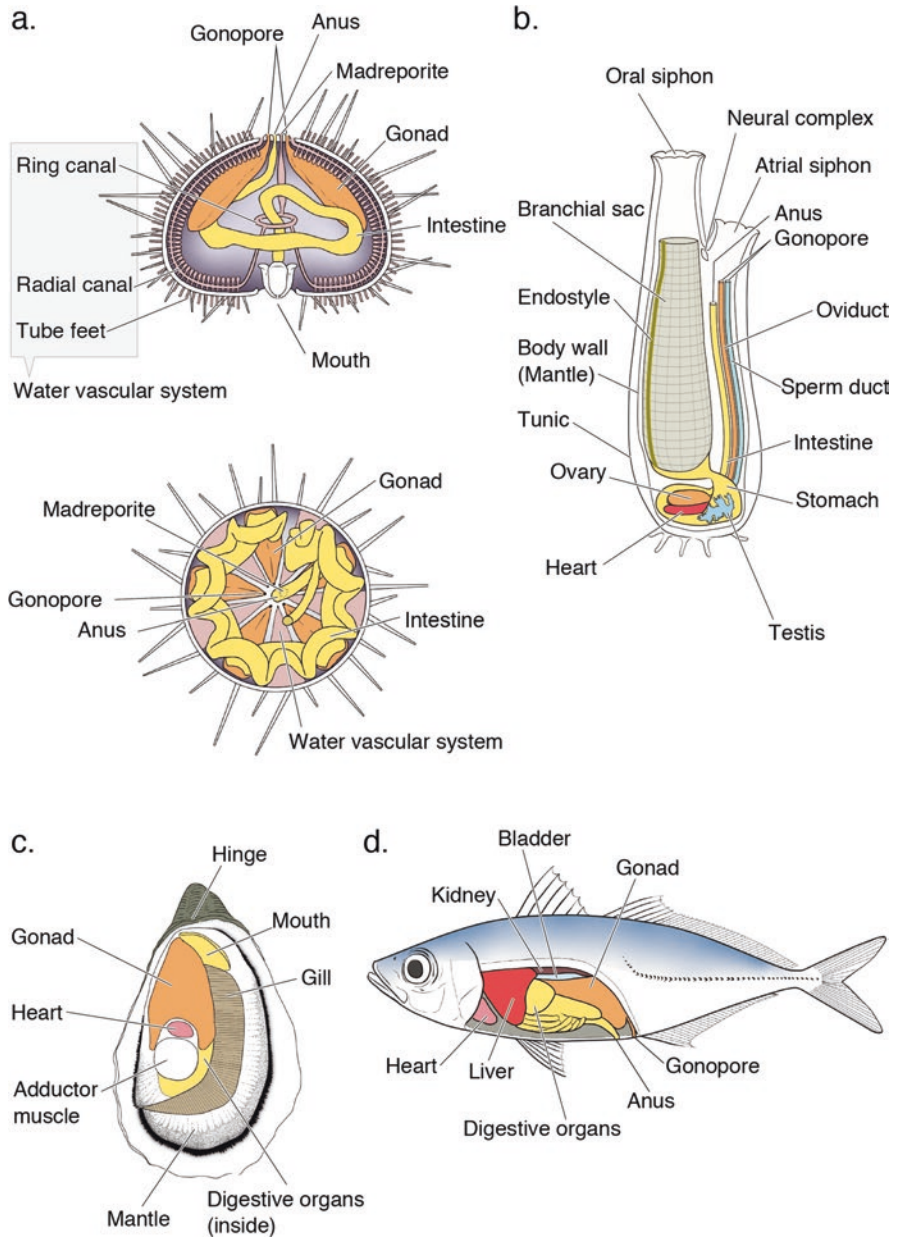
To observe insemination, it is necessary to collect sperm and eggs from sexually ripe individuals. Information on the reproductive seasons of the marine organisms that are useful for gonadal and fertilization observation and experimentation are listed in Table 9.1. For other species, it is recommended to refer to any published articles or survey the process of gonadal maturation in each animal. In fish, reports on the gonad–somatic index (GSI; gonad weight/body weight  $\times$  100) would be a good reference to obtain mature gonads. Gonad size usually correlates with gamete maturation, but it is necessary to check their maturity by morphological observation. Naturally or artificially spawned gametes are usually suitable to use for insemination. Recently, some marine invertebrates with genome information, such as *Ciona intestinalis* (type A) (recently also called *Ciona robusta*) and *Hemicentrotus pulcherrimus*, are available year-round through the National BioResource Project or from marine stations.

---

## 9.2 Sperm and Eggs

**Sperm** Usually mature sperm have three parts: the head (acrosome + nucleus), midpiece (mitochondria), and tail (flagella) (Fig. 9.2). Sperm from some animals are atypical, such as those in ascidians (no midpiece; mitochondrion laterally attached to the nucleus), teleosts (no acrosome), and decapods (aflagellate). Mature sperm are collected from the gonopores after injection with 0.5 M KCl or 1 mM acetylcholine (sea urchins), sperm duct after dissection (*Ciona*), testis after dissection (molluscs, starfish, and fish), and gonopore by squeezing (fish). Sperm quality can be checked by its morphology and motility.

**Eggs** Mature eggs have meiotic stages prior to fertilization: e.g., prophase I (clams), metaphase I (starfishes, ascidians, mussels), metaphase II (teleosts), and after meiosis II (jellyfishes, sea urchins). They are collected by similar procedures to those used to collect sperm. Extracellular structures, or in some case accessory



**Fig. 9.1** Anatomical illustration of gonads in marine animals. (a) Sea urchin (*Heliocidaris crassispina*). (b) Ascidian (*Ciona intestinalis*). (c) Bivalve (*Crassostrea gigas*). (d) Teleost (*Trachurus japonicus*)



**Table 9.1** Spawning seasons of some marine invertebrates in Japan

Animal group	Species	Reproductive season (peak)/place
Echinoderms	<i>Hemicentrotus pulcherrimus</i>	Dec–Mar (Jan–Feb)/Misaki, Shimoda
	<i>Strongylocentrotus nudus</i>	Sep–Oct/Asamushi
	<i>Heliocidaris crassispina</i>	Jun–Sep (Jul–Aug)/Shimoda, Jun–July/Misaki
	<i>Pseudocentrotus depressus</i>	Oct–Dec (Nov)/Misaki
Ascidians	<i>Ciona intestinalis</i> <sup>a</sup>	Sep–Nov (Oct)/Onagawa
	<i>Ciona savignyi</i>	Mar–July, Oct–Dec/Misaki
		Sep–Nov (Oct)/Onagawa
	<i>Halocynthia roretzi</i>	Nov–Mar (Jan)/Asamushi
Bivalves	<i>Herdmania momus</i>	Jul–Sep (Aug)/Shimoda
	<i>Mytilus galloprovincialis</i>	Dec–May (Feb–Mar)/Asamushi
	<i>Crassostrea gigas</i>	Jul–Sep (Aug)/Shimoda

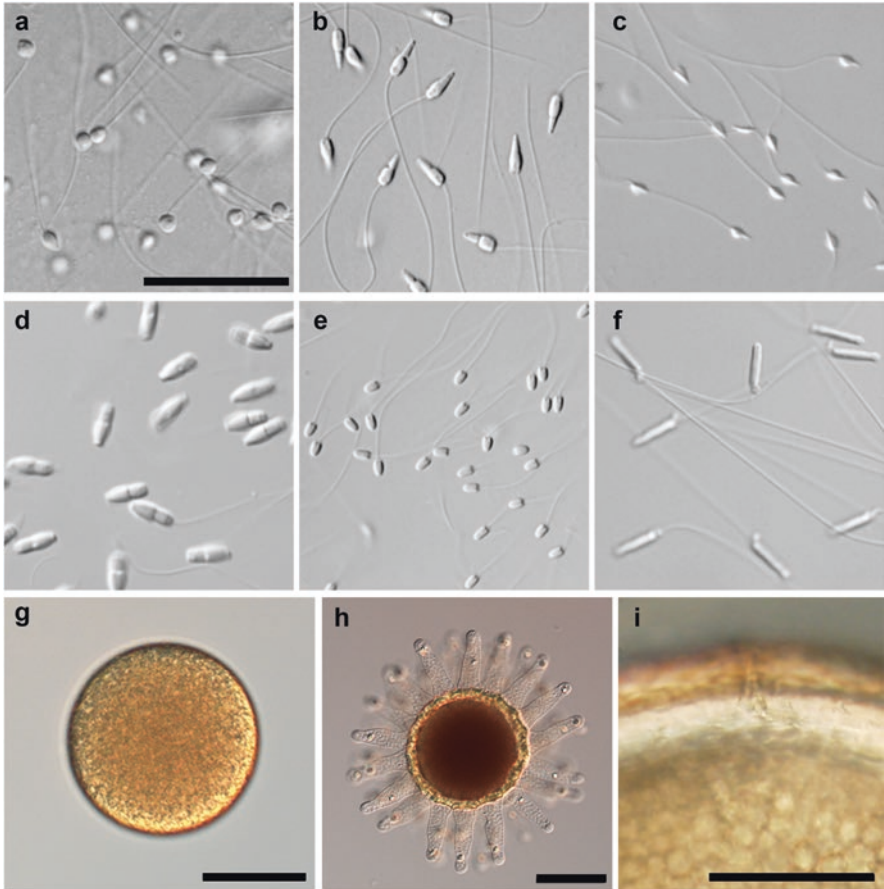
<sup>a</sup>*Ciona intestinalis* (type A) (recently also called *Ciona robusta*). Cultured animals are available year-round through the National BioResource Project

cells, called egg coats, vary among animals. A vitelline membrane (also called chorion in fish and ascidians) surrounds the egg, and its thickness varies among species. Sea urchin eggs are coated in gelatinous material called the egg jelly outside the vitelline membrane. Teleost eggs have a micropyle for sperm entrance in the chorion. In some teleosts, the chorion becomes sticky to adhere to the substratum. Eggs are often enclosed by an egg capsule in some species and are deposited onto various substrata, including rock, seaweed, and sandy seabed (typically seen in gastropods).

### 9.3 Fertilization

In marine species that have external fertilization, sperm initiate motility when they are spawned in response to the changes in several conditions from internal body to the external environments. Sperm motility is activated by egg-derived substances, which also change the symmetry of flagellar waveforms and attract sperm by chemotaxis (Shiba et al. 2008; Mizuno et al. 2012; Movie 9.1). Internal fertilization is seen in several groups of marine animals, including snails and fish. In this type of reproduction, sperm are ejaculated into the female tract. Sperm of these species exhibit several interesting biological strategies, including sperm dimorphism, sperm storage, and sperm competition.

Sperm reach the egg plasma membrane after several events on the egg coat (species-specific recognition, self/nonself recognition in some species, acrosome reaction, and penetration). Interactions between sperm and egg at fertilization are shown for sea urchins in Fig. 9.3. The fertilization membrane is formed by modification of the vitelline coat with the contents of the cortical granules, including transglutaminase and protease (Movie 9.2). The fertilization membrane helps prevent polyspermy, as does depolarization of the egg plasma membrane after sperm–egg

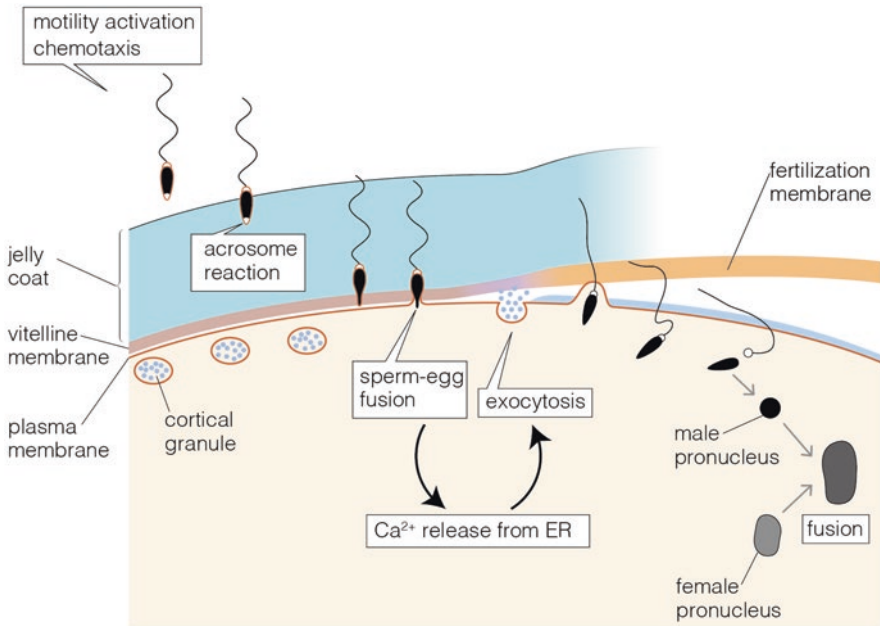


**Fig. 9.2** Diversity in the structures of sperm (a–f) and eggs (oocytes) (g–i) (a) Comb jelly (*Bolinopsis mikado*). (b) Sea urchin (*Hemicentrotus pulcherrimus*). (c) Ascidian (*Ciona intestinalis*). (d) Sea snail (*Omphalius pfeifferi*). (e) Pufferfish (*Takifugu niphobles*). (f) Sturgeon (*Acipenser baerii*). (g) Egg of the sea urchin *Hemicentrotus pulcherrimus*. (h) Egg of the ascidian *Ciona intestinalis*. (i) The region of a micropyle in the egg of the flounder *Pleuronectes yokohamae*. Scale bar, 20  $\mu\text{m}$  (a–f); 100  $\mu\text{m}$  (g–h)

fusion. Sperm bring several components into the egg, among which phospholipase C zeta induces an increase in intracellular  $\text{Ca}^{2+}$  and triggers subsequent post-fertilization events, such as mitosis.

## 9.4 Handling Gametes

In sea urchins, sperm and eggs are obtained by injection with 0.5 M KCl or 1 mM acetylcholine into the body cavity of the male and female using a syringe. In *Ciona* spp. and related ascidians, gametes are obtained from the sperm duct and oviduct,



**Fig. 9.3** The process of fertilization in sea urchins. Prior to fertilization, sperm are activated and attracted to the egg via a component in the egg jelly. After the acrosome reaction, the sperm penetrate through the egg jelly, bind to the vitelline membrane and then to the plasma membrane, and finally fuse with the egg. The vitelline membrane changes into the fertilization envelope and detaches from the egg surface. The sperm nucleus decondenses to form a pronucleus and then fuses with the female pronucleus. Several signaling events occur in both the sperm and egg before and after fertilization

respectively, by dissection. Fish sperm and eggs are obtained by squeezing the abdomen of individuals at the peak of the breeding season but can also be obtained by dissection. In general, gametes are obtained from the sperm duct/oviduct or directly from the gonads and can be used for inseminations; however, for this, they need proper treatments to enable activation and maturation (Inaba and Mizuno 2009).

## 9.5 Experiment 1: Sperm Motility and Its Regulation

In the testis, spermatogonia are differentiated into spermatozoa via the spermatocyte and spermatid. Spermatogenesis is completed in the testis but spermatozoa obtained from the testis cannot fertilize immediately. Sperm function and motility are well regulated to ensure the fertilization of eggs of the same species. Most spermatozoa in the testis are immotile and obtain motility in the sperm duct. After release from the sperm duct, motility initiates outside of the body or inside the female. Afterwards, sperm motility activation events, such as increased flagellar

beat frequency, amplitude of waveforms, and duration of motility, occur. The mechanisms of sperm motility initiation and activation are variable between organisms (Inaba 2003; Morisawa and Yoshida 2005; Dzyuba and Cosson 2014). Here, we describe the procedure of an experiment to learn about the molecular mechanism of sperm motility regulation.

### 9.5.1 Experiment 1–1: Sperm Motility Activation by Egg-Derived Factors

#### Materials

Ascidians (*Ciona intestinalis*, *Ciona savignyi*, *Phallusia mammillata*, *Phallusia nigra*, etc.); Sea urchins (*Heliocidaris crassispina*, *Hemicentrotus pulcherrimus*, *Pseudocentrotus depressus*, *Strongylocentrotus purpuratus*, *Diadema setosum*, etc.).

#### Solutions

Artificial seawater (ASW): 462.01 mM NaCl, 9.39 mM KCl, 10.81 mM CaCl<sub>2</sub>, 48.27 mM MgCl<sub>2</sub>, 10 mM HEPES (pH 8.0).

Ca<sup>2+</sup>-free seawater (CFSW): 478.23 mM NaCl, 9.39 mM KCl, 48.27 mM MgCl<sub>2</sub>, 10 mM HEPES (pH 8.0).

Low-pH seawater: Same reagents as ASW but pH 7.0.

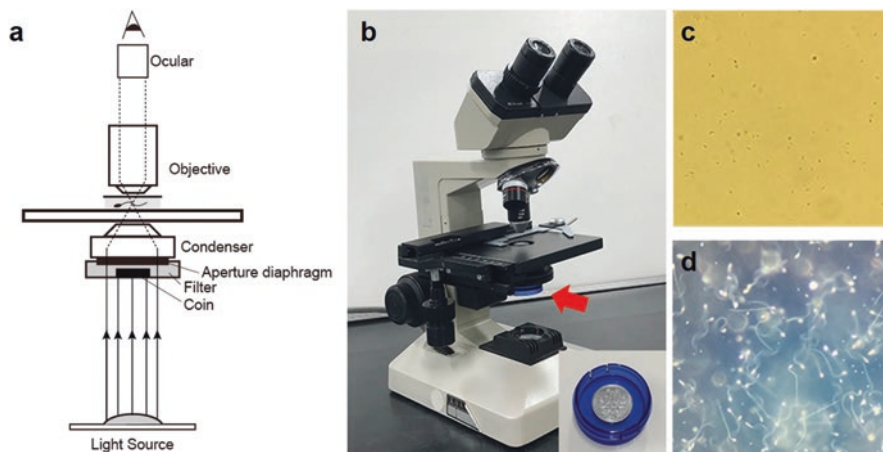
Egg seawater: Incubate eggs in a microtube for 1–2 h and collect supernatant in a new microtube.

#### Methods

1. Collect gametes from ascidians or sea urchins. For ascidians, collect gametes directly from the oviduct or sperm duct by dissection. For sea urchins, collect gametes by injection with 0.5 M KCl into the body cavity (Wessel and Vacquier 2004; Inaba and Mizuno 2009). Keep sperm in a microtube without SW on ice and eggs in a microtube with 0.5–1.0 ml of ASW at 20–25 °C.

Note: Do not contaminate the eggs with the sperm through the sperm pipette.

2. Place a drop (10–20 μl) of test solution onto a 1% bovine serum albumin (BSA)-coated glass slide. Take very small amount of sperm on the tip of the micropipette, add the drop onto the slide and mix gently. BSA is used to avoid sperm adhering.
3. Immediately observe the sperm behavior under the lab-made dark-field microscope (Fig. 9.4). Check the sperm motility, swimming velocity, trajectory (circular or straight), and duration of motility. Use a six-grade evaluation to compare sperm motility as below:  
Score 5: 100–80% motile, Score 4: 80–60% motile, Score 3: 60–40% motile, Score 2: 40–20% motile, Score 1: 20–0% motile, Score 0: immotile.
4. Compare the sperm motility between each solution and discuss the regulatory mechanism of sperm motility.



**Fig. 9.4** Microscopic system for observation of sperm motility (a) Diagram of light path through the dark-field microscope. The coin prevents the transmitted light to enter the objective, instead the light scattered from tiny samples, such as sperm, goes into the objective, visualize them brighter and clearer against the black background. (b) The modified conventional dark-field microscope. The coin placed in the center of the filter (arrow and in box) blocks the transmitted light into the objective. (c) Image of *Ciona* sperm observed by a simple microscope with transmitted light. (d) Image of *Ciona* sperm observed by the modified microscope with this easy dark-field system

Optional: Add calcium ionophore (e.g., 10  $\mu\text{M}$  A23187) or a phosphodiesterase inhibitor (e.g., 1 mM theophylline) to each solution and observe the effect on sperm motility.

## 9.5.2 Experiment 1–2: Sperm Motility Activation by Osmotic Changes

### Materials

Marine fishes (*Sillago japonica*, *Thalassoma cupido*, etc.); Freshwater fishes (*Nipponocypris temminckii*, etc.).

### Solutions

Na1–6: 0, 100, 200, 300, 400, or 500 mM NaCl and 20 mM Tris-HCl (pH 8.0);

M1–5: 200, 400, 600, 800, or 1000 mM mannitol and 20 mM Tris-HCl (pH 8.0).

Note: Prepare the solutions Na2–5 or M2–4 by mixing Na1 and Na6, or M1 and M5, respectively.

### Methods

1. Collect semen from the urogenital opening by squeezing the abdomen or inserting a pipette into the sperm duct (Inaba and Mizuno 2009). Keep semen in a microtube on ice.

Note: Wipe around the urogenital opening using tissue paper before collecting semen to avoid SW or freshwater.

2. Place a drop (10–20  $\mu$ l) of test solution onto a 1% BSA coated glass slide. Take very small amount of sperm on the tip of the micropipette, add the drop onto the slide and mix gently.
3. Immediately observe sperm behavior, as above in Experiment 1–1.
4. Compare the sperm motility between each solution and discuss the regulatory mechanism of sperm motility in fishes.

### How to Make the Customized Dark-Field Microscope (See Fig. 9.4)

The dark-field illumination method allows the imaging of particularly small samples to be displayed brighter and clearer against a black background. The specimen under the microscope is illuminated by oblique light rather than direct light, and therefore this method is useful to observe small cells, such as sperm. You can modify a microscope into a dark-field microscope with a slight improvement to the condenser, as follows:

1. Remove the filter attached under the condenser and the aperture diaphragm.
2. Carefully place a coin in the center of the filter and place the filter onto the microscope. For the 10 $\times$  objective lens, a coin with  $\sim$ 15 mm diameter (e.g., one yen or one cent coin) is recommended. For higher magnification lenses, a larger coin should be used.
3. Adjust the placement of the coin while looking at the image of the sperm under the microscope.

Note: Open the diaphragm to the maximum.

---

## 9.6 Experiment 2: Gamete Collection and Fertilization in Ascidians

*Ciona intestinalis* is a cosmopolitan species and is widely used for studies on reproductive and developmental biology. The spawning period of species in the genus *Ciona* is longer than that of those in other genera (year-round, except for in August and September). Furthermore, they have a short life cycle (3 months), which is useful for genetic studies. In *C. intestinalis*, wild-type and many transgenic lines are supplied from the National BioResource Project (NBRP) (<http://marinebio.nbrp.jp>), supported by Japan Agency for Medical Research and Development (AMED) of Japan.

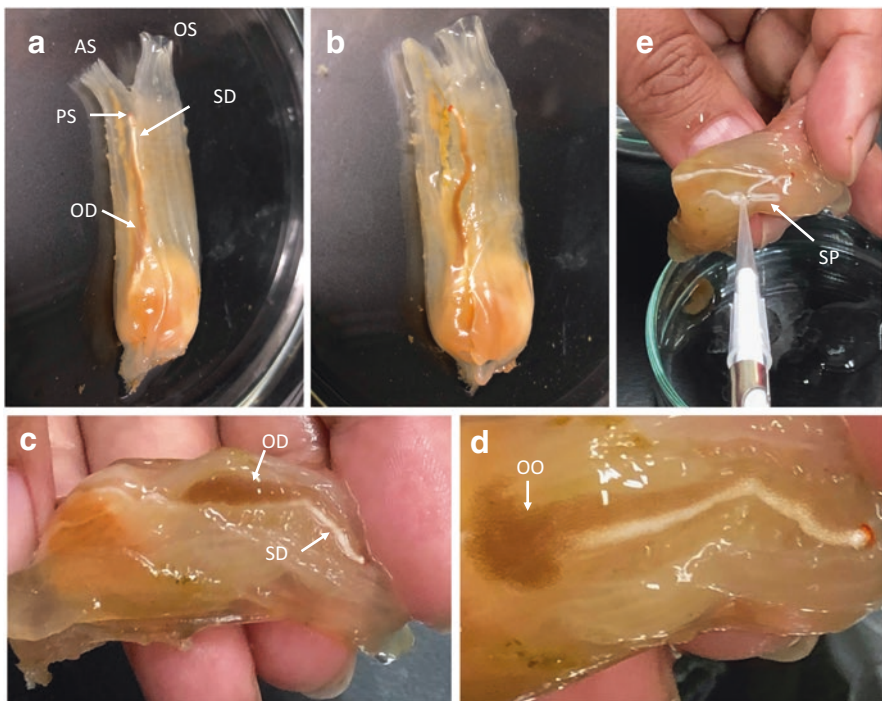
### Materials

1. Filtrated seawater (FSW) or buffered ASW (ex. 462.01 mM NaCl, 9.39 mM KCl, 10.81 mM CaCl<sub>2</sub>, 48.27 mM MgCl<sub>2</sub>, and 10 mM HEPES (pH 8.2)) (Saito et al. 2012);
2. Sexually matured *C. intestinalis*.
3. Glass Petri dishes and Pasteur pipettes (or autopipette).

4. Microtubes to store sperm (1.5 ml).
5. Microscope (at least 4×, 10×, and 40× objectives).

### Collection of Gametes

*Ciona* is a hermaphroditic animal, and the gonads consist of a distinct ovary and testis. An oviduct and a sperm duct are located along the dorsal side of the intestine (see Figs. 9.1b and 9.5). The oviduct lies dorsal to the sperm duct and terminates at the same level. The end of the genital ducts is usually marked by an orange-red spot, which can be seen through the open atrial siphon. The mature sperm duct and oviduct can be identified by them being filled with sperm (white) and eggs (brown), respectively, through the transparent test (or tunic). Eggs and sperm are collected separately from the ducts. Eggs are collected by making a longitudinal incision through the test on the dorsal side, starting just above the atrial siphon, after wiping the body with paper. Care should be taken in cutting the layers underneath the test, since too deep a cut can excise the gonoducts, causing loss of gametes.



**Fig. 9.5** (a) Photograph of the ascidian *Ciona intestinalis*. OD, oviduct; SD, sperm duct; PS, pigment spot; AS, atrial siphon, OS, oral siphon. (b) The inside of the body after cutting tunic and body wall. (c) Exposure of an oviduct (OD) and a sperm duct (SD). (d) Oocytes (OO) released from an incised oviduct. (e) Collecting spilled sperm (SP) after cutting the sperm duct. See also Fig. 1A of Christiaen et al. (2009)

Eggs can be collected from the oviduct using a Pasteur pipette, and should be quickly transferred into a Petri dish containing FSW or ASW. Several thousand eggs can usually be collected from a single mature individual. For fertilization experiments, it is better to keep them at 20 °C in a monolayer and use within 1 h of collection. *C. intestinalis* is hermaphroditic but self-sterile. Therefore, sperm and eggs should be obtained from two different individuals for the fertilization experiment. Care should be taken to collect 'dry' sperm by introducing the autopipette tip into the sperm duct or sucking up the drops coming from the broken sperm duct.

### Fertilization Experiment

1. Appropriate sperm dilution is essential for successful fertilization.
2. Sperm preparation: A sperm dilution series is useful for estimating how few sperm are needed to fertilize eggs. It is important to use the same sperm concentration for each fertilization experiment. Use autopipettes to perform the sperm dilution. Mix each sample gently, and diluted sperm samples should be kept on ice before use.
3. Egg preparation: Pour the egg suspension into a 50 ml beaker filled with seawater and let the eggs settle. Wash the eggs by decantation and gently resuspending with seawater once.
4. Insemination: Place a drop of egg suspension onto a glass depression slide and add the sperm of different individual at an adequate concentration. Usually, the multi-well dishes (48- or 24-well) are used for fertilization experiment by adjusting the final volume to 300  $\mu$ l or 1 ml in each well of the respective multi-well dishes. After insemination, fertilized eggs should be incubated at 20 °C for 1.5 h. The fertilization ratio is determined by counting the number of two-cell embryos and the total embryos/eggs, and expressed as follows:  $(\text{number of two-cell embryo})/(\text{number of total embryos/eggs}) \times 100$ .
5. Self-incompatibility experiment: A small volume of egg suspension is mixed with acidic seawater (pH 2.6) for 1.5 min, followed by hand-driven centrifugation for 30 s to precipitate the eggs. Remove the supernatant and add a sufficient amount of buffered seawater (pH 8.2) to the precipitated eggs. Acid treatment makes the eggs self-fertile. The other protocol for fertilization experiment is the same as the above procedure.

---

## 9.7 Experiment 3: $\text{Ca}^{2+}$ Wave at the Fertilization in Sea Urchins and Ascidians

The change in  $[\text{Ca}^{2+}]_i$  is as an essential factor regulating various cellular events. In egg activation,  $[\text{Ca}^{2+}]_i$  transients have been observed in the fertilized eggs of all species investigated (Miyazaki and Ito 2006; Stricker 1999), and seem to be critical for initiating several events related to egg activation and cell cycle control (Miyazaki and Ito 2006; Runft et al. 2002). Initially, the  $[\text{Ca}^{2+}]_i$  transients in the egg are induced by sperm-egg binding or fusion. In some species, including mammals, a soluble



cytoplasmic factor in the sperm (the sperm factor) initiates the  $[Ca^{2+}]_i$  transients when the factor intrudes into the egg cytoplasm after sperm–egg fusion (Harada et al. 2007; Kyozuka et al. 1998; Saunders et al. 2002; Stricker 1999; Swann 1990). Alternatively, those of the amphibian *Xenopus laevis* egg are induced by the egg surface sperm receptor protein (Sato et al. 2006). The progression of  $[Ca^{2+}]_i$  transients in the egg is generally taxonomic-specific (Stricker 1999).

Though  $[Ca^{2+}]_i$  transients are derived from the extracellular environment in some protostomes, most  $[Ca^{2+}]_i$  transients in deuterostomes are derived from intracellular  $Ca^{2+}$  stores and are regulated by two mechanisms: inositol 1,4,5-trisphosphate ( $IP_3$ )-induced  $Ca^{2+}$  release (IICR) mediated by the  $IP_3$  receptor ( $IP_3R$ ), and  $Ca^{2+}$ -induced  $Ca^{2+}$  release (CICR) mediated by the ryanodine receptor (RyR). Increases in  $[Ca^{2+}]_i$  at fertilization are due to both the IICR and the CICR in sea urchin eggs (Rakow and Shen 1990). On the other hand, IICR seems to be the main mechanism of  $[Ca^{2+}]_i$  elevation in another animals. Unfertilized ascidian eggs are arrested at metaphase I, and fertilization induces two series of  $[Ca^{2+}]_i$  transients (Kyozuka et al. 1998; Yoshida et al. 1998). The  $[Ca^{2+}]_i$  transients are driven by IICR, and they are likely to be required for metaphase–anaphase transition in meiosis (Yoshida et al. 1998).

The first  $Ca^{2+}$  indicator is Quin-2, which is a derivative of the  $Ca^{2+}$  chelator BAPTA (Tsien 1980); nowadays, there are many  $Ca^{2+}$  indicators with various dissociation constants and colors. For indicators, Fluo-4 and Calcium Green-1 are easy to handle when observing  $Ca^{2+}$ -transients in the eggs. On the other hand, Fura-2 is the most popular ‘ratiometric’ indicator and is utilized for the quantitative measurement of  $Ca^{2+}$ , even though two ultraviolet excitation lights are required (Figs. 9.6 and 9.7).

### Observation of $Ca^{2+}$ Oscillation in the Fertilized Ascidian Egg

Animal	<i>C. intestinalis</i> (ascidian)
	<i>Hemicentrotus pulcherrimus</i> (sea urchin)

### Materials

ASW: 460 mM NaCl, 10 mM KCl, 9 mM  $CaCl_2$ , 36 mM  $MgCl_2$ , 17 mM  $MgSO_4$  and 10 mM HEPES (pH 8.2);

Dechorionating medium: 1% sodium mercaptoacetate and 0.05% actinase E in ASW (pH 9);

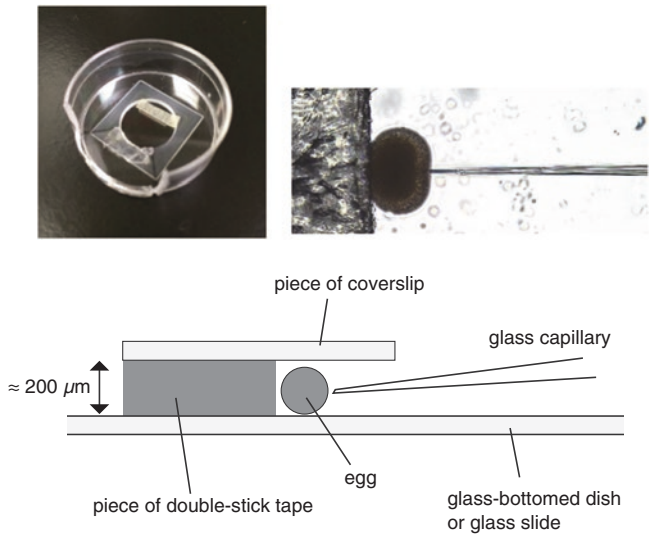
Glass needle ( $\varphi = 1\text{--}5\ \mu\text{m}$ );

Calcium indicators: Calcium Green-1 and Fura-2.

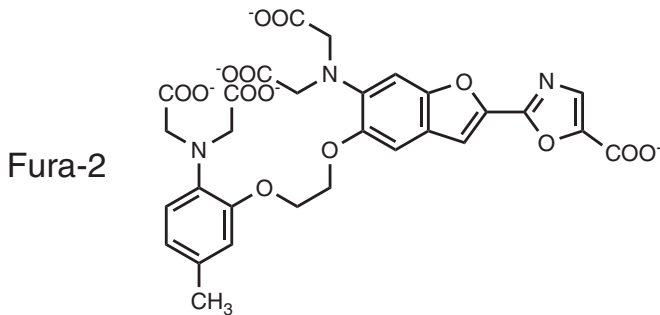
### Methods

1. Obtain semen and eggs from the gonoducts of the ascidian *C. intestinalis* by dissection and keep them on ice and at 18 °C, respectively. Dilute semen about 2000–10,000 times in ASW. Remove the vitelline coat and follicle cells of the

a

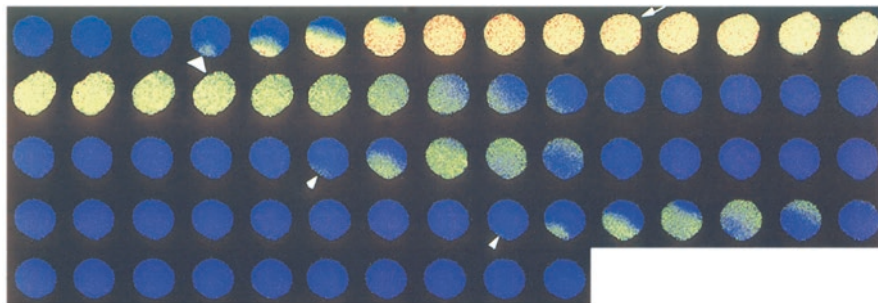


b



**Fig. 9.6** (a) Microinjection of a fluorescent probe into the egg. Upper left, a chamber for microinjection into the ascidian eggs. Upper right, an image of the moment of microinjection into an egg. Lower, a diagram of the microinjection chamber. In order to hold the eggs during injection, we use the chamber. Photo of the ascidian egg during microinjection. (b) Molecular structure of the typical low-molecular-weight  $\text{Ca}^{2+}$  probe Fura-2. Most low-molecular-weight  $\text{Ca}^{2+}$  probes consist of  $\text{Ca}^{2+}$  chelator and chromophore groups

eggs by immersing them in the dechorionating medium. Rinse the eggs with ASW three times after dechorionation. Since the dechorionated eggs are fragile, they should be kept on an agar- or albumin-coated dish.



**Fig. 9.7** Imaging of  $\text{Ca}^{2+}$  oscillation patterns of a fertilized ascidian egg using Fura-2. Images collected every 5 seconds are sequenced left-to-right and top-to-bottom. The changes of  $\text{Ca}^{2+}$  concentration are shown in pseudo-colored images, where yellow/red and blue indicate high and low  $\text{Ca}^{2+}$  concentration, respectively. Thick arrowhead indicates the position of sperm entry. Increase of  $\text{Ca}^{2+}$  induces egg deformation (the onset indicated by an arrow). Thin arrowheads indicate the start positions of second and third  $\text{Ca}^{2+}$  oscillations. This figure is cited from Fig. 2 of Yoshida et al. (1998) (see Movies 9.3 and 9.4 for references)

2. Obtain the semen and eggs of the sea urchin *Hemicentrotus pulcherrimus* by injecting with 0.1 ml of 0.5 M KCl or 1 mM acetylcholine. Rinse the eggs with ASW two times.
3. Microinject the dyes into the eggs using the glass needle. Usually the injection volume of dye is 1/100–1/30 the volume of the egg. Do not use an acetoxymethyl ester form of the indicators when you introduce the indicators into the egg. Usually, eggs of marine animals have active multi-drug resistant transporters, so it is difficult to introduce them.
4. Transfer the dye-injected eggs to another chamber and observe  $[\text{Ca}^{2+}]_i$  with a fluorescent microscope with the imaging application. The excitation and emission wavelengths of the indicators are Ex 490 nm/Em 530 nm (Calcium Green-1), and Ex 340 and 380 nm/Em 510 nm (Fura-2). Observe the differences in the patterns of  $\text{Ca}^{2+}$  waves between the two animals.

## References

- Christiaen, L., Wagner, E., Shi, W., & Levine, M. (2009). The sea squirt *Ciona intestinalis*. *Cold Spring Harbor Protocols*, 2009(12), 138. <https://doi.org/10.1101/pdb.em0138>
- Dzyuba, V., & Cosson, J. (2014). Motility of fish spermatozoa: From external signaling to flagella response. *Reproductive Biology*, 14(3), 165–175. <https://doi.org/10.1016/j.repbio.2013.12.005>
- Harada, Y., et al. (2007). Characterization of a sperm factor for egg activation at fertilization of the newt *Cynops pyrrhogaster*. *Developmental Biology*, 306, 797–808. <https://doi.org/10.1016/j.ydbio.2007.04.01>
- Inaba, K. (2003). Molecular architecture of the sperm flagella: Molecules for motility and signaling. *Zoological Science*, 20(9), 1043–1056.
- Inaba, K., & Mizuno, K. (2009). Purification of dyneins from sperm flagella. In S. M. King & G. J. Pazour (Eds.), *Methods in cell biology* (Vol. 92, pp. 49–63). Amsterdam: Elsevier.

- Kyozuka, K., Deguchi, R., Mohri, T., & Miyazaki, S. (1998). Injection of sperm extract mimics spatiotemporal dynamics of  $\text{Ca}^{2+}$  responses and progression of meiosis at fertilization of ascidian oocytes. *Development*, *125*, 4099–4105.
- Miyazaki, S., & Ito, M. (2006). Calcium signals for egg activation in mammals. *Journal of Pharmacological Sciences*, *100*, 545–552.
- Mizuno, K., Shiba, K., Okai, M., Takahashi, Y., Shitaka, Y., Oiwa, K., et al. (2012). Calaxin drives sperm chemotaxis by  $\text{Ca}^{2+}$ -mediated direct modulation of a dynein motor. *Proceedings of the National Academy of Sciences of the United States of America*, *109*, 20497–20502. <https://doi.org/10.1073/pnas.1217018109>
- Morisawa, M., & Yoshida, M. (2005). Activation of motility and chemotaxis in the spermatozoa: From invertebrates to humans. *Reproductive Medicine Biology*, *4*(2), 101–114. <https://doi.org/10.1111/j.1447-0578.2005.00099.x>
- Rakow, T. L., & Shen, S. S. (1990). Multiple stores of calcium are released in the sea urchin egg during fertilization. *Proceedings of the National Academy of Sciences of the United States of America*, *87*, 9285–9289.
- Runft, L. L., Jaffe, L. A., & Mehlmann, L. M. (2002). Egg activation at fertilization: Where it all begins. *Developmental Biology*, *245*, 237–254. <https://doi.org/10.1006/dbio.2002.0600>
- Saito, T., Shiba, K., Inaba, K., Yamada, L., & Sawada, H. (2012). Self-incompatibility response induced by calcium increase in sperm of the ascidian *Ciona intestinalis*. *Proceedings of the National Academy of Sciences of the United States of America*, *109*, 4158–4162.
- Sato, K., Fukami, Y., & Stith, B. J. (2006). Signal transduction pathways leading to  $\text{Ca}^{2+}$  release in a vertebrate model system: Lessons from *Xenopus* eggs. *Seminars in Cell & Developmental Biology*, *17*, 285–292. <https://doi.org/10.1016/j.semcdb.2006.02.008>
- Saunders, C. M., et al. (2002). PLC zeta: A sperm-specific trigger of  $\text{Ca}^{2+}$  oscillations in eggs and embryo development. *Development*, *129*, 3533–3544.
- Shiba, K., Baba, S. A., Inoue, T., & Yoshida, M. (2008).  $\text{Ca}^{2+}$  bursts occur around a local minimal concentration of attractant and trigger sperm chemotactic response. *Proceedings of the National Academy of Sciences of the United States of America*, *105*, 19312–19317. <https://doi.org/10.1073/pnas.0808580105>
- Stricker, S. A. (1999). Comparative biology of calcium signaling during fertilization and egg activation in animals. *Developmental Biology*, *211*, 157–176. <https://doi.org/10.1006/dbio.1999.9340>
- Swann, K. (1990). A cytosolic sperm factor stimulates repetitive calcium increases and mimics fertilization in hamster eggs. *Development*, *110*, 1295–1302.
- Tsien, R. Y. (1980). New calcium indicators and buffers with high selectivity against magnesium and protons: Design, synthesis, and properties of prototype structures. *Biochemistry*, *19*, 2396–2404.
- Wessel, G. M., & Vacquier, V. D. (2004). Isolation of organelles and components from sea urchin eggs and embryos. In C. A. Ettensohn, G. A. Wray, & G. M. Wessel (Eds.), *Methods in cell biology* (Vol. 74, pp. 491–522). Amsterdam: Elsevier.
- Yoshida, M., Sensui, N., Inoue, T., Morisawa, M., & Mikoshiba, K. (1998). Role of two series of  $\text{Ca}^{2+}$  oscillations in activation of ascidian eggs. *Developmental Biology*, *203*, 122–133. <https://doi.org/10.1006/dbio.1998.9037>



Shunsuke Yaguchi, Yoshiaki Morino, and Yasunori Sasakura

## Abstract

Marine invertebrates are used in developmental, cell, and evolutionary biology, and some critical biological phenomena have been found using these organisms. For example, one of the most important cell-cycle regulator proteins, cyclin, was found in a sea urchin (Evans et al., *Cell* 33:389–396, 1983); the cell-fate determinant, *macho-1*, was first identified in ascidians (Nishida and Sawada, *Nature* 409:724–729, 2001); and it was clearly demonstrated, using spiralian, that the acquisition of a novel gene set could produce new developmental processes (Morino et al., *Nature Ecology & Evolution* 1:1942–1949, 2017). Due to the easy accessibility of their habitats and easily obtained gametes, marine invertebrates have been used for science and education in marine biological stations worldwide. In this chapter, we summarize methods for the use of marine invertebrates to study developmental biology with a focus on sea urchins, ascidians, and gastropods.

## 10.1 Sea Urchins

Two species are widely used for developmental biology courses in marine stations in Japan. *Hemicentrotus pulcherrimus* (Fig. 10.1, left) breeds between December and April, and *Heliocidaris crassispina* (Fig. 10.1, right) breeds between June and September. Other species, such as *Temnopleurus hardwickii*, *Temnopleurus*

---

S. Yaguchi (✉) · Y. Sasakura  
Shimoda Marine Research Center, University of Tsukuba, Shimoda, Shizuoka, Japan  
e-mail: [yag@shimoda.tsukuba.ac.jp](mailto:yag@shimoda.tsukuba.ac.jp)

Y. Morino  
Graduate School of Life and Environmental Sciences, University of Tsukuba,  
Tsukuba, Ibaraki, Japan



**Fig. 10.1** Commonly used sea urchins in developmental biology courses in Japanese marine stations. Left, *Hemicentrotus pulcherrimus*; right, *Heliocidaris crassispina*. Bar = 1.0 cm

*reevesii*, *Scaphechinus mirabilis*, and *Clypeaster japonicus*, are also used, each with different breeding seasons.

### 10.1.1 How to Collect Sea Urchins

*Hemicentrotus pulcherrimus* and *Heliocidaris crassispina* live in the intertidal and shallow subtidal zone, so students are able to collect the adult sea urchins by hand at low-tide time under supervision by marine station staff. If a particular number of sea urchins are required for the course, it is better to ask the staff to collect prior. Because some sea urchin species, including *Hemicentrotus pulcherrimus* and *Heliocidaris crassispina*, are protected under fishing rights, permission from the Japan Fisheries Cooperative is required.

### 10.1.2 How to Collect and Fertilize Gametes and Grow Embryos

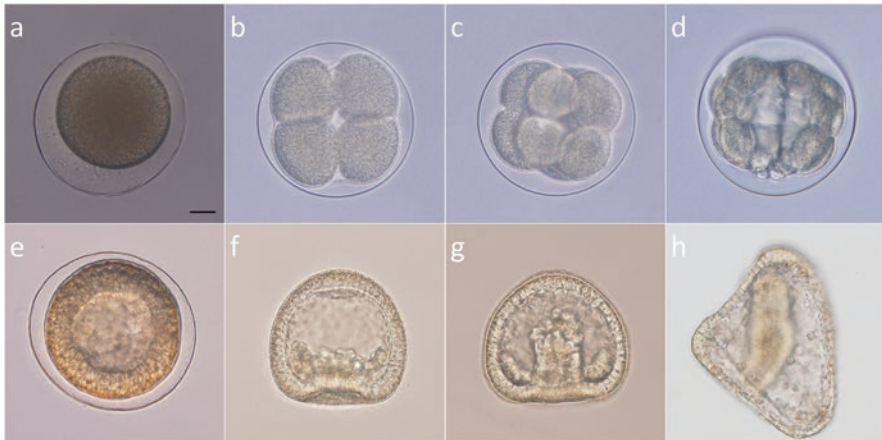
The eggs and sperm of sea urchins are easily obtained in marine laboratory courses. In addition, the fertilization and development of embryos/larvae are easily observed under a microscope. The following protocol explains how to grow sea urchin embryos/larvae from eggs and sperm.

#### Methods

1. Remove Aristotle's lantern (mouth/teeth) and discard the body cavity fluid.
2. Set the adult upside down in a beaker filled with filtered sea water (FSW).
3. Pour 0.5 M KCl into the body cavity and wait for a few minutes.
  - (a) If yellowish eggs are spawned, leave the adult in the beaker until the egg stream stops. Wash the eggs discarding the supernatant seawater and pouring clean seawater into the beaker, repeating three times. Store the eggs at 4 °C

for *Hemicentrotus pulcherrimus* and about 20–25 °C for *Heliocidaris crassispina* until use.

- (b) If white sperm appear, transfer the adult to a 6–10 cm plastic or glass dish and wait until the dry sperm accumulates on the dish. Transfer the dry sperm to a 1.5 ml microtube using a pipette and store at 4 °C until use.
5. To fertilize the eggs, suspend the stored eggs in a beaker filled with FSW at a final concentration of less than 10% volume/volume. Add 1 ml of FSW-diluted sperm (0.2–0.5  $\mu$ l dry sperm) to 100 ml of egg suspension, and wait for 10 min.
6. Discard the supernatant and add new FSW to wash out the extra sperm, repeating several times. Store the fertilized eggs at the appropriate temperature (15–18 °C for *Hemicentrotus pulcherrimus*, and 20–25 °C for *Heliocidaris crassispina*). Because too many eggs interfere with normal development, eggs should be settled as a single layer at the bottom of a glass beaker with plenty of FSW.
7. Observe and sketch the development of sea urchins under a microscope (ref. Fig. 10.2 for *Hemicentrotus pulcherrimus* development). The following are examples of observation and sketching points:
  - Compare the unfertilized and fertilized eggs.
  - When and how are the fertilized eggs divided?
  - Characterize the blastomeres.
  - When and how do the embryos start to move?
  - When and how do they hatch?
  - Characterize the mesenchyme cells.
  - Characterize the gut structure.
  - Characterize the spicules.



**Fig. 10.2** Early development of *Hemicentrotus pulcherrimus*. (a) Fertilized egg, (b) 4-cell stage, (c) 8-cell stage, (d) 32-cell stage, (e) unhatched blastula, (f) early gastrula, and (g) prism larva. Bar = 20  $\mu$ m

### 10.1.3 Experiment 1

#### Observation of the Jelly Coat and Jelly Canal

Unfertilized eggs of sea urchins are covered with a jelly coat, the main components of which are a fucose sulfate polysaccharide and a sialoprotein (SeGall and Lennarz 1979). The jelly coat is invisible under normal conditions because of its transparency. In addition, it is reported that there is a jelly canal at the animal pole of the eggs (Schroeder 1980). The following protocol is to visualize the jelly coat and jelly canal (modified from Maruyama et al. 1985).

#### Methods (Fig. 10.3)

1. Obtain eggs directly (dry eggs) from the gonopores of a 0.5 M KCl-treated adult female with a glass pipette, and transfer them onto a small glass/plastic dish.
2. Apply one drop of black ink (Bokuju in Japanese) around the eggs.
3. Gently pour FSW into the dish.
4. Observe the eggs under a microscope.

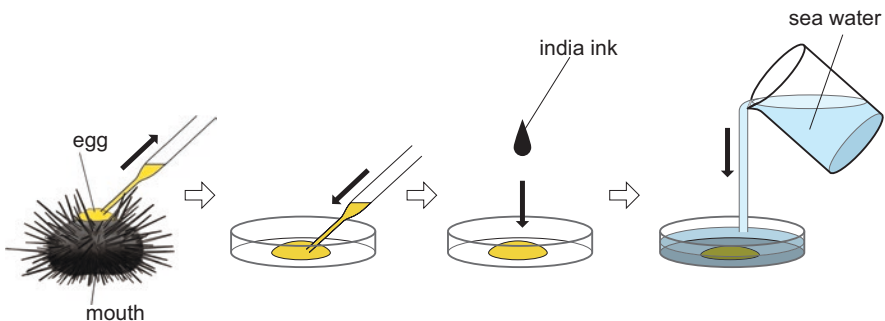
The following are examples of observation points:

- How thick is the jelly coat?
- How can you decide the location of the jelly canal on the egg?
- Without ink, you might realize the presence of jelly coat. Explain this.
- What happens to the jelly coat at fertilization?

### 10.1.4 Experiment 2

#### Fertilization Between Different Species

Unfertilized sea urchin eggs are activated by multiple stimuli. For example, the fertilization envelope is elevated with the intracellular introduction of FSW by



**Fig. 10.3** How to visualize the jelly coat and canal. (a) Collect dry eggs with a pipette. (b) Transfer the eggs onto a glass/plastic dish. (c) Add a drop of black ink (Bokuju in Japanese). (d) Gently pour FSW into the dish, and observe the eggs under the microscope



scratching the cell membrane. An attack by sperm of different species could be an alternative. In addition, when several unknown conditions are in place, cleavage and development occur normally, resulting in swimming embryos being obtained. In fact, hybrid species are sometimes reported in both natural and experimental conditions (MacBride 1912; Brandhorst and Davenport 2001). The following protocol can be used to make a hybrid between different species.

### Methods

1. Prepare dry sperm and eggs of species A (e.g., *Heliocidaris crassispina*) as described in Sect. 10.1.2.
2. Prepare dry sperm and eggs of species B (e.g., *Clypeaster japonicus*).
3. Fertilize egg A with sperm A (control) or B.
4. Fertilize egg B with sperm B (control) or A.  
Examples of experimental conditions:
  - Change the concentration of sperm or eggs.
  - Change the temperature of the FSW.
  - Change the pH of FSW.
  - Change the concentration of ions (e.g., Na<sup>+</sup>, Ca<sup>2+</sup>, or Mg<sup>2+</sup>) in the FSW.
5. If a fertilization envelope is observed, pick up and transfer the fertilized eggs to a new dish or glass beaker filled with FSW.
6. Observe the development of the hybrids, compared to that of the controls.  
Examples of experimental conditions and observation points:
  - Change the temperature for culturing hybrids.
  - How does the cleavage occur?
  - Are there any differences in the morphology, gastrulation, mesenchyme cells, and spicule patterns between the hybrids and controls?

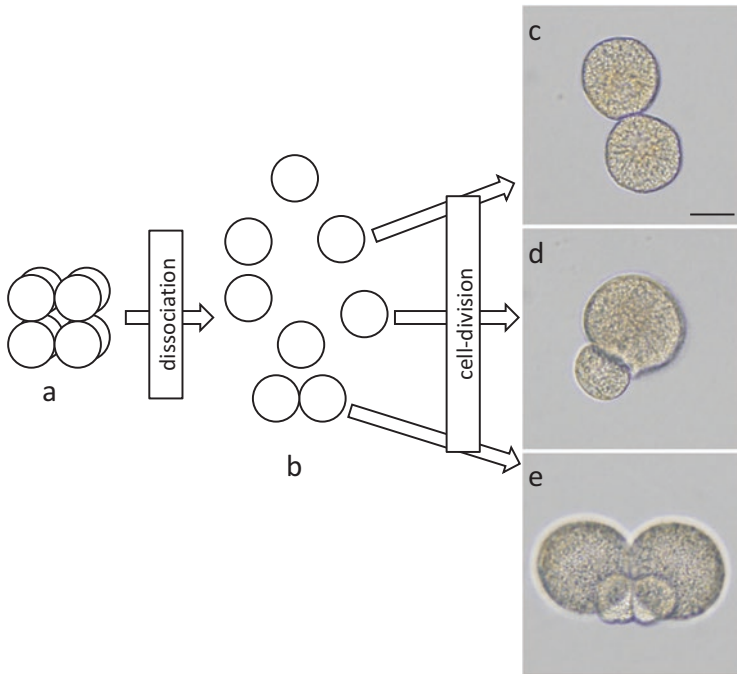
## 10.1.5 Experiment 3

### Isolation of Blastomeres and Culturing the Embryoids

Although sea urchin embryos undergo regulative development, the cell fate of each blastomere is gradually restricted during development. To analyze the developmental potency of each blastomere, a number of researchers have performed blastomere-isolating experiments, in which they use finely pulled glass needle to detach each blastomere under a microscope. This technique is powerful but also requires plenty of experience. Therefore, not all people could succeed in this type of experiment. On the other hand, the following protocol, modified from the method described in Wikramanayake et al. (1995), is relatively easy for students on marine biology courses.

### Methods (Fig. 10.4)

1. Fertilize the eggs with sperm under the conditions of 1 mM 3-amino-1,2,4 triazole (ATA) FSW to keep the fertilization envelope soft.
2. Collect 8-cell stage embryos in a 15 ml tube.



**Fig. 10.4** Blastomere isolation. (a) Schematic image of the 8-cell stage. (b) Schematic image for the dissociated 8-cell-stage embryo into each blastomere(s). After one more cell division, the blastomere will be cleaved into a (c) mesomere pair and a (d) macromere and micromere pair. Embryoids derived from two or more blastomere sets are sometimes obtained. Bar = 20  $\mu\text{m}$

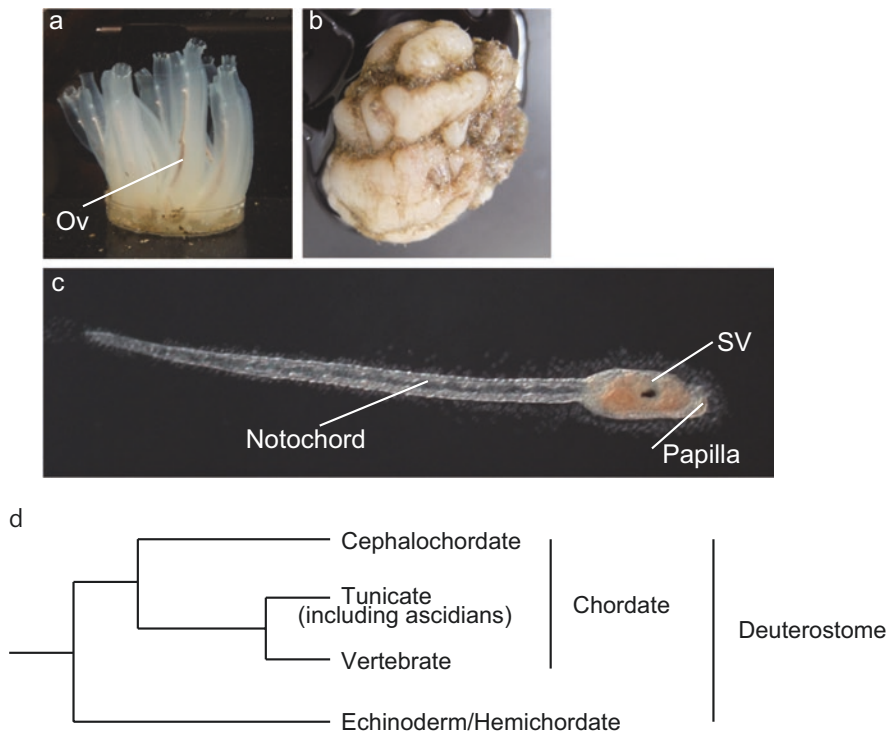
3. Remove the FSW, and wash eggs with  $\text{Ca}^{2+}\text{Mg}^{2+}$ -free SW twice.
4. Wait for about 5 min (depending on the batch).
5. Remove the  $\text{Ca}^{2+}\text{Mg}^{2+}$ -free SW and add 5 ml of  $\text{Ca}^{2+}$ -free SW and close the lid.
6. Shake the tube a few times by hand.
7. Check a part of the dissociated blastomeres under the microscope. If the dissociation is not enough, incubate the sample for another 5 min in  $\text{Ca}^{2+}$ -free SW and repeat shaking. If the cell membrane is broken, shorten the  $\text{Ca}^{2+}\text{Mg}^{2+}$ -free SW incubation time.
8. Transfer the dissociated blastomeres with  $\text{Ca}^{2+}$ -free SW to a 10 cm or 15 cm plastic dish filled with FSW. This dish should be coated with a thin layer of serum (e.g., lamb, bovine, goat, and horse) and dried before use.
9. Pick up the blastomeres with a micropipette and transfer to a FSW-filled 96-well plate coated with 0.5% agarose gel. It is recommended that the FSW contains 50  $\mu\text{g}/\text{ml}$  kanamycin.
10. Wait until the occurrence of the next cleavage, judge the original tier of the blastomere(s), and label it on the well.
11. Let the embryoids grow for as long as possible and observe them under the microscope.

12. Discuss the cell-fate and developmental potency of each blastomere at the 8-cell stage.

## 10.2 Observation of Ascidian Embryogenesis

Tunicates are marine invertebrate chordates that are the closest living relatives of vertebrates (Dehal et al. 2002; Delsuc et al. 2006). As the phylogenetic position suggests, tunicates have the characteristics specific to chordates, such as a dorsally located central nervous system and tubular notochord (Fig. 10.5). Because all tunicate species found so far live in the ocean, the observation of tunicates provides students with the precious opportunity to understand the chordate body plan, its developmental mechanisms, and evolution.

Ascidians form the largest group in the tunicates, and collecting reproductively mature adults, isolating gametes, and performing in vitro fertilization are easy for many species. Thus, ascidians are frequently used as materials for developmental biology. Here, we introduce a basic program using ascidians in our marine course.



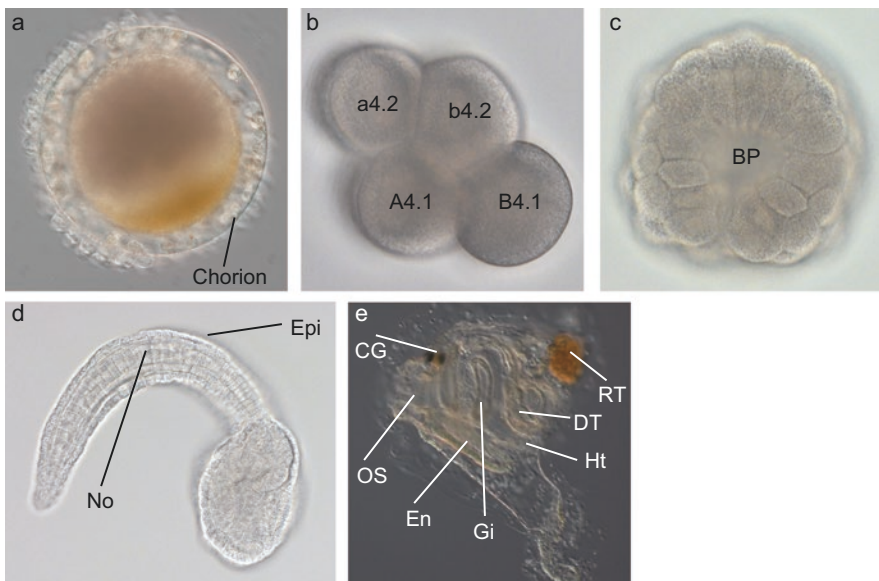
**Fig. 10.5** Ascidians. (a) Adults of *Ciona intestinalis*. Ov oviduct. (b) An adult of *Styela plicata*. (c) A larva of *Ciona intestinalis*. SV sensory vesicle with otolith and ocellus. (d) The phylogenetic relationship of deuterostomes

The purpose of this program is for students to learn the body plan of chordates, mosaic model of cell-fate decision, morphogenetic movement, and metamorphosis; all of which are representative topics in developmental biology.

### 10.2.1 Observation of Myoplasm

In the mosaic model of ascidian embryogenesis, the cell fates of some tissues are determined by substances found in specific regions of eggs and early embryos (reviewed in Nishida 2005). The larval muscle is the representative tissue whose fate is determined by such a maternal factor. Fertilized ascidian eggs and cleaving embryos have a specific cytoplasm named myoplasm. Myoplasm is segregated into the blastomeres that are destined to be larval muscle (Conklin 1905).

The color of myoplasm is different among ascidian species. The myoplasm of *Styela plicata* exhibits a vivid yellow color and is easy to observe in live embryos (Fig. 10.6a). In Japan, *Styela plicata* is a common ascidian and its collection is easy in the summer. Therefore, we recommend using this ascidian for myoplasm observation. If it is difficult to collect this species, you can use alternative species, such



**Fig. 10.6** Embryogenesis of ascidians. (a) A fertilized egg of *Styela plicata* with the chorion. (b) An 8-cell-stage embryo of *Ciona intestinalis*, lateral view. The names of the blastomeres are shown. B4.1 is a posteriorly located blastomere, some of whose daughter cells are differentiated into muscle. Note that the chorion was removed prior to photographing in (b–d). (c) A gastrula embryo. BP blastopore. (d) A tail bud embryo. No notochord, Epi epidermis. (e) A juvenile. CG cerebral ganglion, DT digestive tube, En endostyle, Gi gill, Ht heart, OS oral siphon, RT regressed tail

as *Styela clava* or *Boltenia villosa*. Here, we describe a method for the collection of gametes from *Styela plicata* adults.

### Methods

1. Cut an adult along its midline.
2. Isolate the gonad and place it in a 9-cm plate filled with seawater. The gonad of *Styela plicata* can be recognized by the white color of the testis. The ovary is the brownish zones between the testes.
3. Leave for several tens of minutes. During the incubation, mature sperm will exude around the gonad. Collect dense sperm with a pipette and store on ice.
4. Both mature and immature eggs will be ejected around the gonad. Transfer the mature eggs onto another plate with seawater. Immature eggs have a large germinal vesicle at the center. Mature eggs are somewhat bigger than immature eggs and the germinal vesicle is invisible.
5. Mix the eggs and sperm to start fertilization. Ascidians are hermaphroditic and have self-sterility. It is thus usually better to mix sperm and eggs isolated from different individuals. However, surgically isolated *Styela plicata* eggs are frequently fertilized with self-sperm during isolation.
6. Observe myoplasm and its segregation pattern to specific blastomeres that are fated to differentiate into muscle.

## 10.2.2 Observation of Embryogenesis of *Ciona intestinalis*

The model ascidian species, *Ciona intestinalis*, is used worldwide as experimental material for molecular biology, and the delivery system of its wild-type animals has been established in some nations, including Japan (Sasakura et al. 2009). Because the system guarantees us to be able to obtain reproductively mature *Ciona* adults in a reproducible manner, we recommend using *Ciona* to observe ascidian embryogenesis.

### Methods

1. Prepare two reproductively mature *Ciona* adults. The white and brownish lines are the spermiduct and oviduct, respectively (Fig. 10.5a). Cut the body along the oviduct with fine scissors while taking care not to injure the oviduct or spermiduct. Pierce the oviduct with the tip of some scissors and collect the eggs on a plate filled with seawater.
2. Repeat the procedure to collect the eggs from two animals. Before dealing with the other animals, make sure to wash your hands and instruments with tap water to inactivate any contaminated sperm. This is necessary to prevent untimely fertilization.
3. Collect sperm from the spermiduct with a pipette and preserve it on ice until use.
4. Divide eggs between a few 9-cm plates. Usually, one *Ciona* adult has too many eggs to culture on one plate. Reducing the number of eggs per plate will prevent embryogenesis from going wrong due to a high density of embryos.

5. Fertilize the eggs to start embryogenesis. Dilute the sperm with seawater to be somewhat cloudy. Add a few drops of diluted sperm to the plate with the unfertilized eggs. Immediately pipette the eggs to facilitate simultaneous fertilization. Record the time of insemination.
6. Check for the occurrence of fertilization. Unfertilized eggs are a perfect sphere. After fertilization, eggs change their shape due to the ooplasmic segregation (Sardet et al. 1989). After this event, fertilized eggs become oval and the shape change is a signature of fertilization. If the morphological change does not occur, repeat insemination with sperm from a different individual.
7. Observe under a microscope (Fig. 10.6b–d).  
Examples of observation points are as follows:
  - Shape of unfertilized eggs with chorion, follicle cells, and test cells;
  - Measure time of cleavages after fertilization to make a developmental table;
  - Shape of embryos at the cleaving stages;
  - Gastrulation;
  - Neurulation;
  - Tail bud formation.
8. Because *Ciona* larvae have representative characteristics specific to chordates (Fig. 10.5c), it is important to sketch the larva to understand the chordate body plan.  
The points of the sketch will be as follows:
  - The number of adhesive papillae.
  - Shape of otolith and ocellus.
  - Sensory vesicle.
  - Endoderm.
  - Muscle.
  - Primordia of the oral and atrial siphons.
9. Observation of juvenile (Fig. 10.6e). The transparency of *Ciona* juveniles, with functional organs, such as the endostyle, gill, heart, stomach, and digestive tube, provides students with an excellent chance to deepen their understanding of tissue/organ composition in adult ascidians. Ascidian hearts do not possess the cardiac valve and the direction of blood circulation changes periodically; this can also be observed. When using *Ciona* juveniles in a marine course, you may need to prepare them prior to the course; it takes at least 1 week for *Ciona* to reach the stage appropriate for observation.

### 10.2.3 Electroporation

Introduction of exogenous DNA into a living organism is used to examine gene functions, for labeling cells, and indicating tissue development and function. Generally, transgenic techniques require a long time and advanced skills, such as microinjection; these aspects make it difficult to carry out the experiments during a marine course. An important advantage of using *Ciona* is the ease of introducing exogenous DNA by electroporation (Corbo et al. 1997). Thus, *Ciona* is an ideal

animal to learn the methodology of transgenic techniques. Various methods of transgenic techniques in ascidians are available in Sasakura (2018).

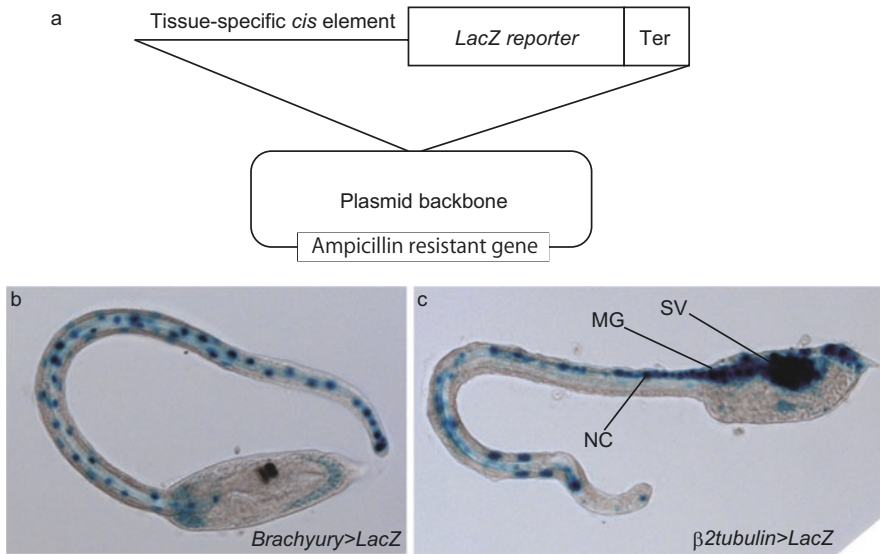
### Methods

1. Collect the unfertilized eggs and sperm as described above.
2. Pour 10 ml of dechoronation solution (1% sodium thioglycolate and 0.05% actinase E in seawater) into a 6-cm plate coated with gelatin. Then, add 300  $\mu$ l of 2 M NaOH. Homogenize the liquid by pipetting.
3. Transfer unfertilized eggs onto the plate with the activated dechoronation solution. Gently mix the eggs while avoiding a bubbly appearance. Continue pipetting periodically.
4. Observe the eggs with a stereoscopic microscope. The chorion becomes yellowish in the solution. Dechorionated eggs are brownish smooth balls.
5. When most eggs are dechorionated, gather the dechorionated eggs by slowly rotating the plate. Then, quickly transfer the eggs into another gelatin-coated plate filled with seawater. Repeat this step once more.
6. Dissolve a few microliters of dry sperm into seawater to activate the sperm. Add a few milliliters of diluted sperm into the plate containing the dechorionated eggs.
7. Observe fertilization with a stereoscopic microscope. The eggs will rotate due to the collision with the sperm. If no action is observed add diluted sperm from another animal. The occurrence of fertilization can be recognized by the morphological change in the eggs. Leave for 15 min after insemination if fertilization successfully occurs.
8. Collect the fertilized eggs and wash them with 0.693 mM D-mannitol in seawater (Mannitol-SW) once. Use a 10 ml glass centrifuge tube and hand rotator for this purpose. After the eggs sink by gentle rotation, discard the Mannitol-SW and add an appropriate volume of fresh Mannitol-SW by calculating as follows: one electroporation requires eggs in 300  $\mu$ l of Mannitol-SW.
9. Mix 30–60  $\mu$ g of DNA (in 80  $\mu$ l of 1 $\times$  Tris-EDTA [TE] buffer) with 420  $\mu$ l of Mannitol-SW. Add the DNA solution to a 4 mm cuvette. Then, add 300  $\mu$ l of Mannitol-SW with eggs into the cuvette. Mix gently by pipetting several times and insert the cuvette into the shock pod. Push the start button to start pulsing. When using the Gene Pulser II (Bio-Rad, CA, USA), the recommended parameters of the pulse are 50 V and 20 ms.
10. Recover the eggs into a gelatin-coated plate filled with seawater. Exchange the seawater once to reduce the remaining DNA. Culture overnight at 18 °C.

When a fluorescent protein is used as the reporter gene in the electroporated plasmid, students can observe its expression in living embryos using a fluorescent microscope. When *lacZ* is used as the reporter gene, staining is necessary prior to observation (Fig. 10.7; Hikosaka et al. 1992).

### Methods

1. Collect embryos in a 1.5 ml test tube. Add a 1/10 volume of formalin. After gentle mixing, incubate for 15 min.



**Fig. 10.7** Electroporation. (a) The schematic illustration of the reporter construct. Ter, transcription termination signal sequence. (b–c) Expression of  $\beta$ -galactosidase in larvae into which a lacZ expression construct was electroporated at the 1-cell stage. The name of the construct is shown at the bottom of the panels. (b)  $\beta$ -galactosidase is expressed in the notochord. (c)  $\beta$ -galactosidase is expressed in the nervous system. MG motor ganglion, NC nerve cord, SV sensory vesicle

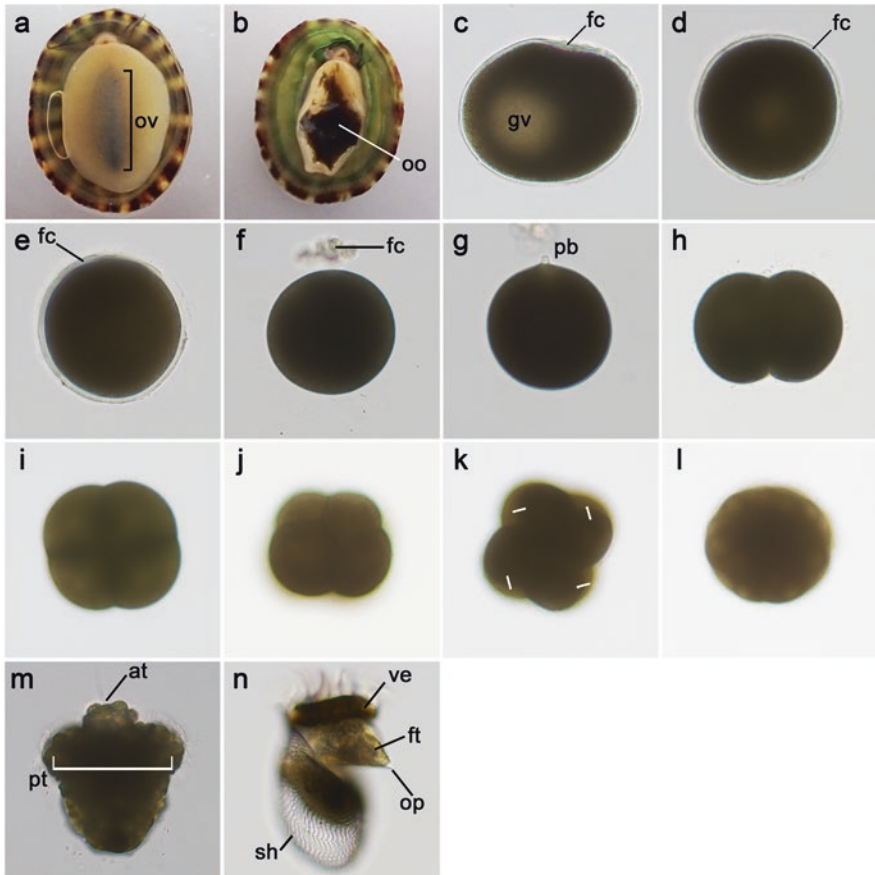
2. Wash embryos with phosphate buffered saline with 0.1% Tween 20 (PBST) twice. Usually, 200  $\mu$ l is sufficient to wash the embryos. Spin down the embryos gently before removing the liquid. Carrying out the washing step under a stereoscopic microscope will prevent the loss of embryos.
3. Wash once with the staining solution (1 mM  $MgCl_2$ , 3 mM potassium ferricyanide, 3 mM potassium ferrocyanide in PBST. Store at 4  $^{\circ}C$  before use).
4. Add 200  $\mu$ l of staining solution, and then add 2  $\mu$ l of X-gal (10 mg/ml).
5. Incubate for 30–60 min at 37  $^{\circ}C$ . If the signal is weak, extending the incubation time will yield a better result without increasing the background signal.

In our marine course, we use the reporter constructs expressing *lacZ* in the notochord, neural tissue, and muscle (Fig. 10.7). The constructs are available from the National BioResource Project in Japan (<http://marinebio.nbrp.jp/ciona/>).

### 10.3 Spiralian Development

The Spiralia are a superphylum of protostomes, characterized by stereotypical early development, such as spiral cleavage and conserved fate of blastomeres (Lambert 2010; Laumer et al. 2015). Many molluscan species have orthodox spiralian development. Here, we introduce a method of artificial fertilization and early





**Fig. 10.8** Early development of *Nipponacmea fuscoviridis* (a, b) Adult female specimen of *Nipponacmea fuscoviridis* with mature ovary. *ov* ovary, *oo* oocytes. (c) Untreated, immature egg. *ft* follicle cells, *gv* germinal vesicle. (d) Egg 10 min after ammonia treatment. The eggs become spherical and the germinal vesicle fades. (e) Egg 30 min after treatment. The germinal vesicle has broken down and is invisible. (f) Egg 50 min after treatment. The follicular cells have disappeared. (g) Egg 30 min after fertilization. The first polar body is released. *pb*, polar body. (h) The 2-cell stage, 1 h post-fertilization (hpf). (i) The 4-cell stage, 1 h and 20 min post-fertilization (mpf). (j) The 8-cell stage, 1 h and 45 mpf, lateral views with the animal pole uppermost. The animal blastomeres are smaller than the vegetal blastomeres. (k) The 8-cell stage; view from the animal pole. The shifted arrangement of the animal and vegetal blastomeres is caused by the oblique direction of cleavage. (l) The morula stage, 3 hpf, lateral view. (m) Early trochophore larva, 5.5 hpf. *at* apical tuft, *pt* prototroch. (n) Veliger larva, 24 hpf. *ve* velum, *ft* foot, *op* operculum, *sh* larval shell

development for the limpet *Nipponacmea fuscoviridis* (phylum Mollusca, class Gastropoda), which inhabit the intertidal zone of rocky shores in Japan (Fig. 10.8a). *Nipponacmea fuscoviridis* is useful for observing the early development of spiralian as they are common on Japanese coasts and it is easy to culture adult specimens in laboratory aquaria (Deguchi 2007). Unlike many spiralian species, which

have a limited reproductive season, *Nipponacmea fuscoviridis* can be fertilized artificially for more than half of the year. The artificial fertilization procedure for this species is established and simple (Deguchi 2007) and the speed of development is rapid; therefore, it is possible to observe development within a short period of time.

### 10.3.1 Obtaining Gametes

The gonads ripen several times per year. For example, specimens collected from Hiraiso shore (Ibaraki, Japan) in January–February, June–July, and October–November, 2018 had mature gonads. From the ventral side, the mature ovary appears black or dark green (Fig. 10.8a), and the testes look yellowish white.

#### Methods

1. Cut the midline of the body of a female specimen to obtain oocytes (Fig. 10.8b) and place them in 10 ml of ASW. These immature oocytes remain in the first meiotic metaphase. Immature eggs are not spherical, surrounded by follicular cells, and the germinal vesicle can be seen (Fig. 10.8c).
2. To obtain mature eggs, add 200  $\mu$ l of 250 mM  $\text{NH}_4\text{Cl}$  and 500 mM Tris (pH 9.0) to ASW containing the oocytes (final concentration: 5 mM  $\text{NH}_4\text{Cl}$  and 10 mM Tris) and incubate for 10 min (Deguchi 2007).
3. Wash the oocytes three times in ASW.

The ammonia treatment induces egg maturation; the eggs become round, the germinal vesicle breaks down, and the follicular cells detach (Fig. 10.8d–f). The maturation process occurs rapidly, so the eggs should be observed immediately after starting the ammonia treatment. Most eggs become suitable for fertilization after 40–60 min of ammonia treatment at room temperature (20–25 °C).

Examples of observation points are as follows:

- Transition of egg shape;
- Follicular cells;
- Germinal vesicle breakdown (GVBD).

### 10.3.2 Fertilization

#### Methods

1. Cut the midline of the male body and dilute the sperm in ASW. Untreated sperm do not move actively.
2. To activate the sperm, add a few drops of 250 mM  $\text{NH}_4\text{Cl}$  and 500 mM Tris (pH 9.0) to ASW containing the sperm. The sperm will start swimming rapidly after this treatment.
3. Mix the activated sperm and eggs to fertilize the eggs. Incubate for 10 min.
4. Wash the fertilized eggs three times in ASW to remove the remaining sperm.

Development proceeds normally about 20–25 °C. We usually culture the embryos in ASW at 22 °C.

An example of an observation points is as follows:

- Comparison of sperm movement before and after activation by ammonia.

### 10.3.3 Early Development

The first polar body is released about 30 min post-fertilization (mpf) (Fig. 10.8g). The first cleavage occurs at about 1 h post-fertilization (hpf) (Fig. 10.8h). After the first cleavage, a new cleavage occurs every 20–25 min (Fig. 10.8h–k). In the 8-cell stage, two general features of spiralian development can be observed: (1) the animal daughter blastomeres are smaller than the vegetal daughter blastomeres (Fig. 10.8j) and (2) cleavage proceeds at an oblique angle relative to the animal–vegetal axis (Fig. 10.8j, k). The embryos reach the morula stage at about 3 hpf (Fig. 10.8l). At 5–6 hpf, the embryos start swimming with cilia cells on the prototroch (Fig. 10.8m). The larval shell forms on the dorsal side at 12–14 hpf. Maintaining a low density (<10 specimens/ml) decreases the failure rate of normal shell formation. The shells of veliger larvae cover their posterior bodies (Fig. 10.8n). Although adult limpets lack an operculum, the veliger larvae have an operculum on the foot (Fig. 10.8n).

Examples of observation points are as follows:

- Polar bodies;
- First and second cleavage;
- Spiral and unequal cleavage at the 8-cell stage;
- Start of swimming;
- The larval shell and velum at the veliger larval stage;
- Presence of the operculum.

**Acknowledgments** We thank M. Kiyomoto, T. Sato, D. Shibata, M. Ooue, T. Kodaka, J. Takano, and M. Yamaguchi for collecting and keeping the adult sea urchins. We thank Y. Satou, M. Yoshida, R. Yoshida, C. Imaizumi, and S. Aratake for providing wild-type *Ciona* through the National BioResource Project, Japan. We further thank K. Mita for providing photographs of *Ciona* embryos. We thank H. Wada and N. Hashimoto for helping with the collection of limpets and constructing the protocol for the artificial fertilization of limpets.

---

## References

- Brandhorst, B. P., & Davenport, R. (2001). Skeletogenesis in sea urchin interordinal hybrid embryos. *Cell and Tissue Research*, 305, 159–167.
- Conklin, E. G. (1905). Organ forming substances in the eggs of ascidians. *Biological Bulletin*, 8, 205–230.

- Corbo, J. C., Erives, A., Di Gregorio, A., Chang, A., & Levine, M. (1997). Dorsoventral patterning of the vertebrate neural tube is conserved in a protochordate. *Development*, *124*, 2335–2344.
- Deguchi, R. (2007). Fertilization causes a single  $\text{Ca}^{2+}$  increase that fully depends on  $\text{Ca}^{2+}$  influx in oocytes of limpets (phylum Mollusca, class Gastropoda). *Developmental Biology*, *304*, 652–663.
- Dehal, P., et al. (2002). The draft genome of *Ciona intestinalis*: Insight into chordate and vertebrate origins. *Science*, *298*(5601), 2157–2167.
- Delsuc, F., Brinkmann, H., Chourrout, D., & Philippe, H. (2006). Tunicates and not cephalochordates are the closest living relatives of vertebrates. *Nature*, *439*(7079), 965–968.
- Evans, T., Rosenthal, E. T., Youngblom, J., Distel, D., & Hunt, T. (1983). Cyclin: A protein specified by maternal mRNA in sea urchin eggs that is destroyed at each cleavage division. *Cell*, *33*, 389–396.
- Hikosaka, A., Kusakabe, T., Satoh, N., & Makabe, K. W. (1992). Introduction and expression of recombinant genes in ascidian embryos. *Development, Growth & Differentiation*, *34*, 627–634.
- Lambert, J. D. (2010). Developmental patterns in spiralian embryos. *Current Biology*, *20*, R72–R77.
- Laumer, C. E., Bekkouche, N., Kerbl, A., Goetz, F., Neves, R. C., Sørensen, M. V., et al. (2015). Spiralian phylogeny informs the evolution of microscopic lineages. *Current Biology*, *25*, 2000–2006.
- MacBride. (1912). Hybrid Sea-urchins. *Nature*, *89*, 450.
- Maruyama, Y. K., Nakaseko, Y., & Yagi, S. (1985). Localization of cytoplasmic determinants responsible for primary mesenchyme formation and gastrulation in the unfertilized egg of the sea urchin *Hemicentrotus pulcherrimus*. *Journal of Experimental Zoology*, *236*, 155–163.
- Morino, Y., Hashimoto, N., & Wada, H. (2017). Expansion of TALE homeobox genes and the evolution of spiralian development. *Nature Ecology & Evolution*, *1*, 1942–1949.
- Nishida, H. (2005). Specification of embryonic axis and mosaic development in ascidians. *Developmental Dynamics*, *233*, 1177–1193.
- Nishida, H., & Sawada, K. (2001). Macho-1 encodes a localized mRNA in ascidian eggs that specifies muscle fate during embryogenesis. *Nature*, *409*, 724–729.
- Sardet, C., Speksnijder, J. E., Inoue, S., & Jaffe, L. (1989). Fertilization and ooplasmic movements in the ascidian egg. *Development*, *105*, 237–249.
- Sasakura, Y. (2018). Advances in experimental medicine and biology. In *Transgenic ascidians* (p. 1029). Singapore: Springer.
- Sasakura, Y., Inaba, K., Satoh, N., Kondo, M., & Akasaka, K. (2009). *Ciona intestinalis* and *Oxycomanthus japonicus*, representatives of marine invertebrates. *Experimental Animals*, *58*, 459–469.
- Schroeder, T. E. (1980). The jelly canal marker of polarity of sea urchin oocytes, eggs, and embryos. *Experimental Cell Research*, *128*, 490–494.
- SeGall, G. K., & Lennarz, W. J. (1979). Chemical characterization of the component of the jelly coat from sea urchin eggs responsible for induction of the acrosome reaction. *Developmental Biology*, *71*, 33–48.
- Wikramanayake, A. H., Brandhorst, B. P., & Klein, W. H. (1995). Autonomous and non-autonomous differentiation of ectoderm in different sea urchin species. *Development*, *121*, 1497–1505.



# Development of Marine Fish: Several Procedures for the Observation of Embryonic Development

# 11

Etsuro Yamaha, Rie Goto, Taiju Saito, Eisuke Takahashi, Takahiro Matsubara, and Katsutoshi Arai

## Abstract

The technologies of developmental biology have been improving over the past 30 years. Full genome sequencing enables between species comparisons, and genomics have revealed continuous genetic relationships between species. Genetic manipulation, such as modification of specific genes and genetic improvements, has been getting easier by gene editing technology, if fresh fertilized fish eggs are prepared and cultured. On the other hand, micro-manipulation, such as micro-operation of embryos, also opens a new possibility of surrogate production. Gametes have been induced through germ-line chimera induced artificially by germ-cell transplantation between different species. In this context, the intercellular interaction between species with different genomes is an important subject to be analyzed. In this section, general methods are described for artificial fertilization and cultivation in teleosts, and a few methods useful for experimental embryology are introduced. Then, observation procedures and development are described in several species. Finally, some experiments are introduced to study embryonic mechanisms in freshwater species. These experiments may be possible in other species if chorion can be removed at the early embryonic stage.

**Electronic supplementary material** The online version of this chapter ([https://doi.org/10.1007/978-981-15-1326-8\\_11](https://doi.org/10.1007/978-981-15-1326-8_11)) contains supplementary material, which is available to authorized users.

E. Yamaha (✉) · E. Takahashi  
Field Science Center for Northern Biosphere, Hokkaido University, Nanae, Japan

R. Goto · T. Saito · T. Matsubara  
South Ehime Fisheries Research Center, Ehime University, Ainan, Japan

K. Arai  
Institute for the Advancement of Higher Education, Hokkaido University, Sapporo, Japan

## 11.1 Introduction

The technologies of developmental biology have been improving over the past 30 years. Particularly, full genome sequencing enables between species comparisons, and genomics have revealed continuous genetic relationships between species. In teleosts, full genome sequences have been performed in several species, such as pufferfish (*Fugu rubripes*), rainbow trout (*Oncorhynchus mykiss*), zebrafish (*Danio rerio*), and medaka (or Japanese rice fish, *Oryzias latipes*). Genetic information from these organisms is useful for analyzing the genetic relationships with other species.

In teleosts, germ-line chimerism has been induced by germ-cell transplantation between different species. By using this technique, it is possible to develop breeding methods, such as genetic improvement and cellular selection techniques. In surrogate propagation, transplanted donor germ cells are required to differentiate the gametes in the host gonadal environments. Therefore, the intercellular interaction between germ cells and somatic cells is an important subject to be analyzed between species with different genomes. It is important to elucidate the mechanism(s) of embryonic induction during morphogenesis.

Fertilized eggs have holoblastic cleavage in some ancient teleost species, such as *Polypterus* spp. and sturgeon, while almost all other teleosts have discoidal cleavage during the early stages of development. The embryonic development of holoblastic species is very similar to that of amphibians. The embryonic development of discoidal species is different to that of reptilian and avian species. In addition, discoidal eggs show two types of yolk distribution: a single yolk mass and yolk granules in a single egg. The yolk in the former type is enclosed with a limited membrane and separated from the egg cytoplasm. In the latter type, yolk granules, which are also enclosed with a limiting membrane, are scattered in the egg cytoplasm. This difference in yolk distribution affects the cleavage pattern of development, especially the formation of the yolk syncytial layer (YSL), described later in this chapter. After fertilization, the egg cytoplasm moves to the animal pole side, while the yolk granules move to the vegetal pole, resulting in the blastodisc with egg cytoplasm being formed around the animal pole.

The embryonic development of discoidal eggs is subdivided into the following periods in zebrafish: cleavage, blastula, gastrula, segmentation, pharyngula, and hatching. During these periods, epiboly, the movement and spreading out of blastoderm cells over the yolk, occurs. As egg sizes vary between species, the differentiation of organs depends on the period, not on the percentage of epiboly. The order of normal organogenesis is similar in the normal development of teleosts, but the speed is variable because of the egg size and environmental conditions, such as temperature and oxygen concentration. Therefore, observing the detailed staging of embryonic development with student experiments at marine stations is difficult. The comparative analysis of different stage embryos is effective to understand the differentiation of tissues and/or organs.

Synchronous cleavages occur throughout the blastoderm, then change to asynchronous cleavages at the mid-blastula transition. Three cell lineages, namely the enveloping layer (EVL), deep cell layer (DCL), and yolk syncytial layer (YSL), are

established around this stage. The EVL is an extra-embryonic epithelial monolayer covering the blastoderm. The DCL is the origin of the embryonic body itself. The YSL is thought to be the organizing center, inducing the mesoderm and endoderm cells in the teleost blastoderm. The YSL and underlying yolk are collectively called the yolk cell. Without the yolk cell, the blastoderm could not differentiate the normal embryonic body with the central nervous system. The establishment of the YSL during the early cleavage stage is different between eggs with one single yolk and those with many yolk granules. Observation is monotonous during the cleavage stage, but it is important in the differentiation of the three germ layers to partition the maternal cytoplasm with its determinants.

The blastoderm, with the EVL, DCL, and YSL, begins to spread out of yolk, and forms the germ ring and embryonic shield, called the gastrula. DCL cells around the marginal part internalize under the peripheral part of the blastoderm and form a thickened germ ring. The mesoderm and endoderm cells are internalized, and the remaining upper cells are ectoderm cells. One part of the internalized cells moves toward the animal pole, forming the embryonic shield. The embryonic shield marks the dorsal side of the embryo. The side of the animal pole is anterior and the marginal part of the embryonic shield is posterior. The dorsal/ventral, anterior/posterior, and right/left axes are clearly distinguishable after the appearance of the embryonic shield. Thereafter, the shield cells move toward the animal pole, and the upper ectoderm cells and internalized mesoderm and endoderm cells move dorsally and form the embryonic body. The dorsal part of the embryonic body, the ectoderm, is called the epiblast, and the ventral part, the mesoderm and endoderm, is called the hypoblast. The central part of the hypoblast, the axial mesoderm, differentiates the notochord along the anteroposterior axis.

Somites differentiate from the paraxial part of the hypoblast and increase in number from the anterior to posterior. This process is called somitogenesis. The number of somites is an indicator of the developmental staging during somitogenesis. The skeletal muscle, dermis, and spine are the main derivatives of somite. The differentiation of muscle is observable, but that of the latter two is difficult to distinguish from the outside. The differentiation of muscle is distinguishable by comparison between the anterior and posterior somites during somitogenesis, because of the striped pattern of the muscle fiber. The embryo begins to become motile after muscle differentiation.

Simultaneously, in the epiblast, the brain and sensory organs begin to differentiate during the somitogenesis stage. The brain first divides into three parts: the forebrain, midbrain, and hindbrain, and following this, the spinal cord is differentiated. Thereafter, the telencephalon and diencephalon, mesencephalon, and rhombencephalon and myelencephalon differentiate from the forebrain, midbrain, and hindbrain, respectively. Morphological observation of these brain derivatives is easy at the early stage but becomes difficult with the expansion of the brain ventricle. Morphogenesis of the eye and ear, the sensory organs, is fascinating. The eyes are originated from a horizontal extrusion of the forebrain, called the optic vesicle. The optic vesicle consists of two cell walls, and the cavity between the walls links the brain ventricle. The outer wall of the optic vesicle becomes thickened and invaginated, converting into an

optic cup. The lens originates from the thickening of the epithelium over the optic vesicle and falls into the cup. The outer and inner walls of the optic cup differentiate the sensory and pigmented retinas, respectively. The inner ear originates from the thickening of the sensory layer of the ectoderm, known as the otic placode. The placode cells invaginate and then form a vesicle. Thereafter, the ventral part of the vesicle thickens and forms a sensory layer, and an otolith located on it. Three semi-circular canals differentiate around the dorsal part of the vesicle. These processes can be observed from outside using a binocular microscope.

The establishment of the cardiovascular system is a very impressive period of development, but the initiation of the heartbeat and blood flow around the pharynx is difficult to detect from outside using a binocular microscope. The heartbeat starts just ventrally to the pharynx. Blood cells begin to differentiate around several parts of body, namely the central mesoderm and on the yolk sac.

The hatching stage is different among species. Embryos of many pelagic species, such as flatfish, hatch before the opening of the mouth and anus, while those of some demersal species, such as salmonids, hatch after the establishment of some juvenile characters. The timing of hatching is affected by environmental conditions, such as temperature and high density of eggs, even in the same batch of the same species.

During embryogenesis, germ-line cells differentiate from the blastomeres with maternal germplasm in teleosts. The germplasm is distributed throughout the zygote cytoplasm, colonized on the cleavage furrows at the early cleavage stages. Founders of germ cells, primordial germ cells (PGCs), are destined from the blastomeres that inherited germplasm and are established around the blastula stage. PGCs migrate from their original appearance position to the final gonadal region. It is impossible to observe the germplasm and PGCs during embryogenesis using a normal or binocular microscope. Recently, however, it has been possible to visualize these with GFP fluorescence by injecting artificial mRNA into the cytoplasm at the early cleavage stages. Visualized PGCs show fascinating movement, extrusion of filopodia and lamellipodia, under a fluorescent microscope during migration.

In this section, we describe the general method for artificial fertilization and cultivation, at first, and introduce a few methods useful for experimental embryology. Then, we describe the observation procedures and development of anchovy, herring, smelt fish, and ice goby, as some examples. Finally, we show some experiments to study embryonic mechanisms in freshwater species, such as zebrafish and goldfish. These experiments may be carried out on other species with demersal eggs whose chorions are removable at the early embryonic stage.

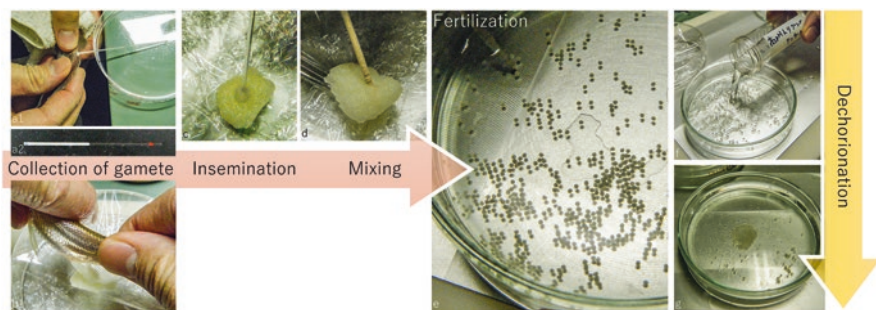
---

## 11.2 General Method

### 11.2.1 Parent Fish and Gametes

In the spawning season, gametes are obtained from mature fish captured at spawning grounds or cultured at fishery experimental stations. As egg properties, such as transparency, adhesion, ocean zone (pelagic/demersal), isolation/aggregation,





**Fig. 11.1** Flowchart of the fertilization (a–e) and dechoriation (f, g) of smelt fish. (a1) Collection of sperm from mature male into a microcapillary tube. (a2) Collected sperm. (b) Squeezed eggs on plastic wrap. (c) Insemination of sperm into the eggs. (d) Gentle mixing with a tooth pick. (e) Fertilization of eggs in the environmental water. (f) Treatment with enzyme solution. (g) Denuded eggs without chorions

and so on, are highly diverse, the choice of species is also important to observe morphogenesis.

Eggs are squeezed from mature females onto a sheet or into a vessel without contamination with environmental water, which activates the development (Fig. 11.1). Sperm are collected into a capillary tube or plastic cup, also without contamination. Generally, artificial fertilization is performed as follows: eggs inseminated with sperm are scattered into environmental water (seawater or freshwater, depending on the spawning habitat). After fertilization, additional washing with environmental water is recommended in order to remove excess sperm.

During cultivation, the daily removal of dead embryos and changing of water should be performed in order to prevent the deterioration of water quality. In the case of pelagic eggs, adding a small amount of salt to the culture medium makes the medium exchange easier, because of the floatation of surviving embryos. The more seawater allowed for cultivation, the higher the embryo survival rate. In the case of adhesive eggs, as the removal of dead eggs is laborious, a low-density cultivation is recommended. In both cases, as the hatching stage is subject to mass mortality, embryos should be cultivated in a large vessel. When observing the floating eggs with a microscope, it is difficult to observe from the side because of the oil droplet in the yolk. Better results may be obtained by incubating the embryos in Ringer's solution (see Goto et al. 2019).

### 11.2.2 Softening and Dechoriation

The chorions of several species are removable by hand and/or enzymatic procedures. In eggs without chorions, detailed observation of morphogenesis and organogenesis is easy. Embryonic manipulation, such as blastoderm and blastomere transplantation, is also available in denuded embryos. In addition to this, you can try to inject some artificial material, such as a fluorescent reagent,

artificial mRNA, or gRNA for genome editing, into the egg cytoplasm, if chorion softening and/or dechoriation are performed. Some methods for chorion softening and dechoriation are described for example species in following subsections. In closely related species, with the exception of those with floating eggs such as anchovy, the chorion may be removable using a similar treatment with slight modifications. We also summarize modifications to the dechoriation and/or chorion softening methods (Tables 11.1) and the developmental schedule (Table 11.2) for several fish species.

### 11.2.3 Microinjection

We have already described the procedures for microinjection for a few types of eggs, including the preparation of the injection needle, operation of manipulator, and treatment of fertilized eggs (Goto et al. 2019). Please refer to the relevant description for microinjection. Microinjection enables us to label some blastomeres or specific cells, such as PGCs. For tracing cell lineage, FITC-dextran is available, according to Kimmel and Low (1985). Five percent of FITC-dextran solution in 0.2 M KCl should be injected into one of the upper tiers of the blastomeres that are isolated. For histological tracing, a mixed solution of FITC-dextran and biotin-dextran-lysine is useful. Labeled cells are stained on

**Table 11.1** Handling procedures of chorion for micro-injection and micro-surgery

		References
1. Injection after removal		
Gobius fish, medaka	Manual removal	Saito et al. (2006), Iwamatsu (1988)
Zebrafish, loach, dace	Trypsin pH 7	Saito et al. (2006, 2010)
Goldfish, common carp	0.1% trypsin and 0.4% urea pH 7	Yamaha et al. (1986), Ito et al. (1999)
Medaka	Hatching enzyme	Sakai (1961)
Smelt fish	0.1% trypsin after high pH treatment	Takahashi et al. (2016)
2. Injection after softening or after inhibition of hardening		
Herring	Softening by 0.1% trypsin and 1% urea pH 7	Saito et al. (2006)
Salmonid species	Inhibition of hardening by glutathion reduced	Yoshizaki et al. (1989)
3. Direct injection without treatment just after fertilization		
Eel, barfin flounder, anchovy	Direct injection through chorion	Saito et al. (2011), Goto et al. (2015)
Salmonids species	Direct injection through micropyle	Guyomard et al. (1989)
4. Difficult		
Brown sole	Too small	
Greenling	Tough adhesive materials	

**Table 11.2** Rough developmental schedule of each fish species described in this chapter

Stage name	Time	Pond smelt	Ice goby (19°C)	Goldfish	J. anchovy <sup>a</sup>	Zebrafish	Characteristics (mainly referred from pond smelt)
Species	Herring						
Temperature	8–10 °C	10 °C	19 °C	20 °C	24 °C	28.5 °C	
<i>Cleavage period</i>							
Fertilization							Attach to matrix by outer layered adhesive membrane, forming perivitelline space
1-cell	2 h	2 h 30 min		40 min	0 min		Formation of the blastodisc on the animal pole
2-cells	3 h 40 min	5 h	45 min	1 h	24 min	45 min	Formation of the first cleavage furrow
4-cells		6 h 30 min	1 h 35 min	1 h 30 min	51 min	1 h	Blastodisc formed by 2 × 2 array blastomeres
8-cells		8 h	2 h 30 min	2 h 10 min	1 h 18 min	1 h 15 min	Blastodisc formed by 2 × 4 array blastomeres
16-cells		9 h 30 min	3 h 30 min	2 h 40 min	1 h 45 min	1 h 30 min	The fourth cleavage plane divided the monolayered blastomeres horizontally
32-cells		11 h	4 h 40 min	3 h 10 min	2 h 12 min	1 h 45 min	
64-cells		12 h 30 min	5 h 55 min	3 h 50 min	2 h 39 min	2 h	The number of blastomeres became uncountable by external appearance
Early blastula period							
128-cells		14 h		4 h 20 min	3 h 6 min	1 h 45 min	
256-cells		15 h 30 min		4 h 50 min	3 h 33 min	2 h 30 min	

(continued)



Embryonic body	3 days	1 day 3 h	20 h	12 h	10 h	Completion of the blastoderm covering on the yolk cell, embryonic body was formed
Bud	3 days 12 h	1 day 6 h				Embryonic body expand rapidly by drastic conversion and extension movement
<i>Segmentation period</i>						
5-somite	2 days 12 h	4 days	1 days 2 h	14 h	11 h 40 min	Beginning of somitogenesis, optic vesicle formation
9-somite	2 days 17 h	4 days 12 h	2 days 4 h	16 h	16 h	Kupffer's vesicle formation, beginning of optic cup formation
15-somite	3 days	5 days	2 days 11 h	20 h	14 h	Optic cup and lens placode formation, otic placode formation started
22-somite		5 days 12 h	3 days 8 h			
28-somite	3 days 13 h	6 days	4 days 12 h		17 h 30 min	Lens formation
34-somite		6 days 12 h				Beginning of eye pigmentation, extinction of Kupffer's vesicle
39-somite		7 days	5 days	2 days		Otoliths and nasal placode formation, tail part began to bend to right side of the body, mobility
44-somite		7 days 12 h				Actively moved tail part
50-somite	5 days 13 h	8 days	6 days	3 days	21 h 30 min	Pectoral fins formation, beginning of heart beating

(continued)

Table 11.2 (continued)

Stage name	Time	Pond smelt	Ice goby (19°C)	Goldfish			Characteristics (mainly referred from pond smelt)
Species	Herring					J. anchovy <sup>a</sup>	Zebrafish
Temperature	8–10 °C	10 °C	19 °C	20 °C	24 °C	24 °C	28.5 °C
54-somite		8 days 12 h					Beginning of caudal fin fold and intestinal tract formation
58-somite		9 days					Beginning of median fin fold formation
62-somite		9 days 12 h					Completion of somitogenesis, lumen of intestinal tract became observable from outside
<i>Pharyngula period</i>							
		10 days					Beginning of hatching glands formation at the middle region of dorsal body trunk and pigmentation at lower part of intestinal tract
		11 days					A lot of hatching glands appeared at dorsal body trunk
		12 days					Semicircular canals formation, anterior part of gut's lumen became large
		13 days					Many pigments were formed at the lower part of gut tract, liver could be observed from outside, formation of lateral line, tail part became straight shape
	11 days	15 days	8 days				Mouth opening and gill arch formation
		16 days					Weak peristaltic motion was observed in part of intestinal tract, hatching glands with reflective granules
		18 days					Open anus, beginning of hatching and swimming
<i>Hatching period</i>							
	11 days 6 h	20 days 12 h	13 days	5 days	27 h 40 min	2 days	More than half of embryos cultivated with chorion hatched

<sup>a</sup>Fertilized eggs of Japanese anchovy were obtained in the tank by natural spawning at around 35 min before embryo reached one cell stage

the histological sections by histochemical procedures, using an avidin-peroxidase complex. To visualize the germplasm and PGCs, artificially synthesized mRNA (*bucky ball*-GFP and *GFP-nos3* 3'UTR, respectively) should be injected, according to Saito et al. (2006, 2014).

The actual process of the injection is as follows. First, place the dish with eggs onto the stage of a stereomicroscope and position the tip of the injection needle. The needle tip should be leveled to the top end of the eggs. Then, apply small pressure with the microinjector to let the needle leak a small amount of the solution into the seawater. The operations of microinjection are very simple. Just move the egg to the center of the microscopic view and insert the needle into it. Move the tip of the needle back and forth using a micromanipulator. Repeat these steps until you obtain enough injected embryos. To identify the injected embryos, you may want to add tracer dye, such as FITC-dextran or rhodamine-dextran, into the solution. If the injector's pressure is properly applied to the needle, the leaking solution can be injected into the egg. Remove the needle from the egg when the diameter of the injected solution reaches 1/10–1/5 that of the egg. When the internal pressure of the egg is too high to inject the solution, we recommend using an injection needle with 'break', as described by Goto et al. (2019). You can see the process in barfin flounder (Fig. 11.2) and anchovy (Fig. 11.3a). There is also a movie showing the actual process of microinjection in goldfish (Movie 11.1).

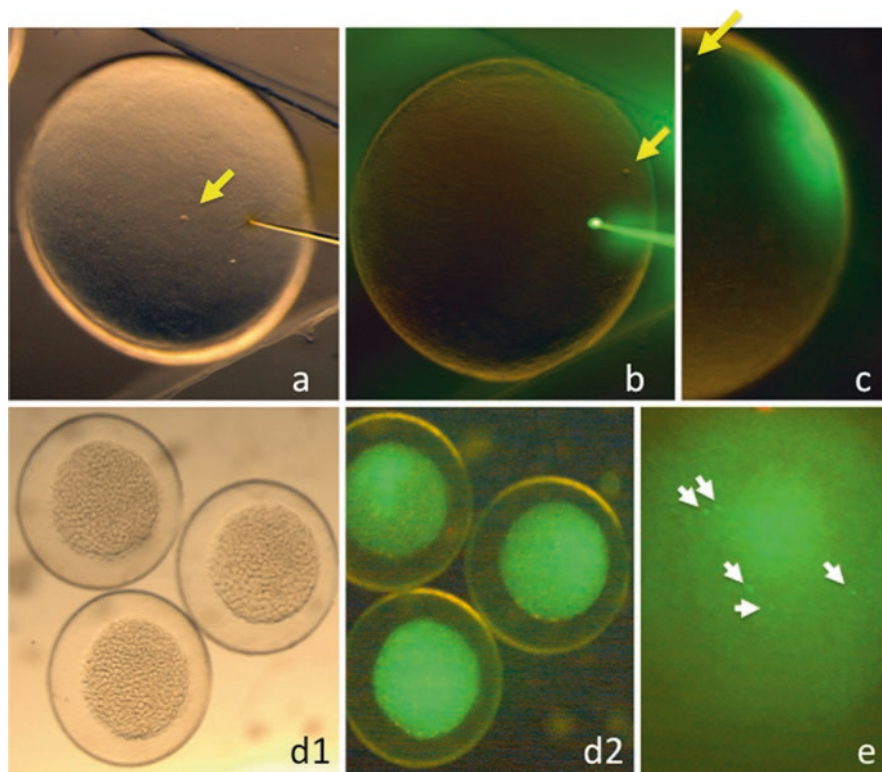
---

## 11.3 Experimental Procedures of Eggs and Embryos in Several Species

### 11.3.1 Japanese Anchovy (Floating Pelagic Eggs)

Japanese anchovy, *Engraulis japonicus*, is a marine pelagic fish that inhabits the north western and central Pacific, including the coastal areas of Japan. The reproductive characteristics of the Japanese anchovy differ, depending on the distribution area and are correlated with temperature and condition factor (Funamoto et al. 2004; Takasuka et al. 2005). The size at first maturity is estimated to be around 7 cm, and most fish mature at around 9 cm in body length (Funamoto and Wada 2004). Under captive conditions, sexual maturation occurs within 3–4 months at 22–28 °C (Yoneda et al. 2015). Although the reproductive characteristics of Japanese anchovy vary among stocks or rearing conditions, fertilized eggs can be reliably obtained at certain times, usually a few hours after dark, when fish are reared at a temperature of 20–26 °C (Yoneda et al. 2013; Pandey et al. 2017a, b). According to Yoneda et al. (2013), the range of ovulation cycle in each female varies from two to more days, depending on sea water temperature and nutritional condition. In our observations, during active spawning season, the cycle becomes shorter; the females likely spawn 3 or 4 days. The control of the full life-cycle of the Japanese anchovy is relatively easy compare to that of other marine species; therefore, this species is a suitable marine fish for developmental studies.

Adult fish can be maintained in a circular tank, with a recommendation of 100 fish/1000 L. A tank larger than 1000 L is preferable since fish can damage themselves by swimming into the walls of the tank. To maintain spawning adults, fish



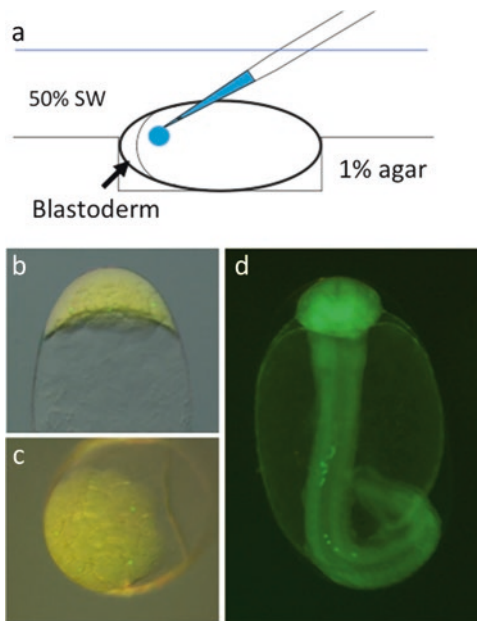
**Fig. 11.2** Injection with fluorescent reagent into a fertilized egg of barfin flounder. **(a)** Backlight view, showing the injection point of the fertilized egg. **(b)** Fluorescent view showing an injection with FITC-dextran. **(c)** Lateral fluorescent view showing the distribution of FITC-dextran in a fertilized egg. FITC solution is only distributed in the blastodisc. Yellow arrows indicate micro-pyles. **(d)** Blastula stage developed from injected eggs with GFP-*nos3* 3'UTR mRNA. **(d1)** Backlight view. **(d2)** Fluorescent view. Blastomeres with visualized germplasm are shown in the eggs when the chorions are removed. **(e)** Visualized primordial germ cells (PGCs) (white arrows) in dissociated blastomeres

should be reared in a flow-through seawater system with 300–500% exchange in a day, enough aeration with/without oxygen generator to keep dissolved oxygen between 5 and 7 mg/L and photoperiod of 14:10 L:D (Pandey et al. 2017a, b). Pellets were fed at about 3–5% of body weight per day over 12 h with an automatic feeder. The main spawning time was between 21:00 and 22:00 h when fish reared temperature at 19–21 °C and daylight from 6:00 to 20:00 h (Pandey et al. 2017a). Therefore, checking the spawning time by scooping surface seawater from rearing tank the day prior to the experiment is recommended. It is not suggested that a fish net is used to collect the eggs since the fertilized eggs of the Japanese anchovy are quite fragile and are easily damaged once exposed to air.

Once the spawning time is determined, observe the fish carefully and transfer a mature male and female (with swollen belly, a sign of ovulation) to the 1000 L tank

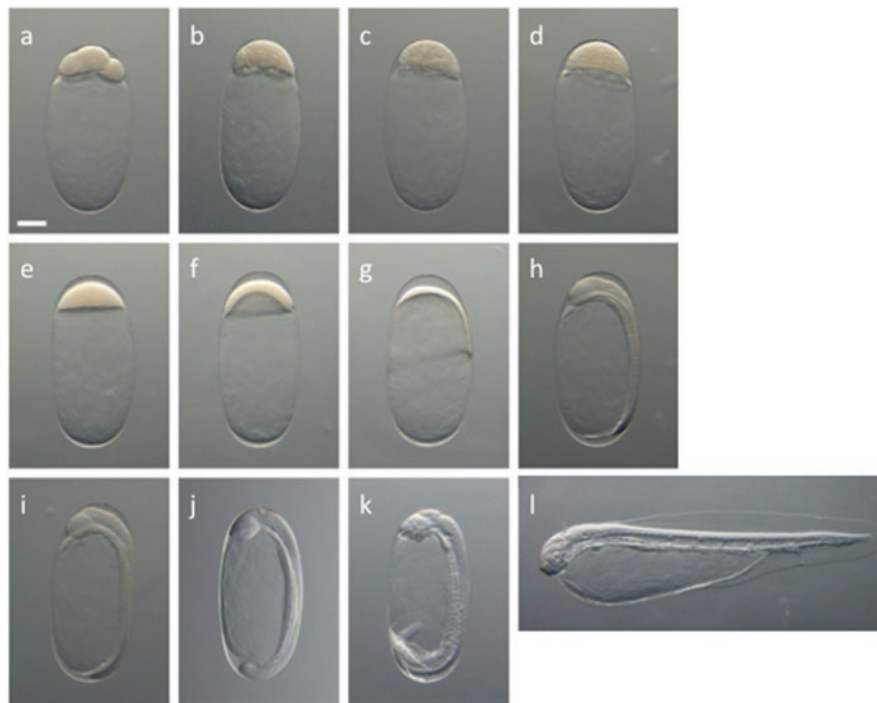


**Fig. 11.3** (a) Schematic illustration of microinjection in an anchovy egg, and (b and c) visualization of primordial germ cells (PGCs) by injecting bucky ball-GFP RNA or (d) GFP-*nos3* RNA. (b) A side view and (c) an animal polar view of an embryo at the 128-cell stage. (d) A ventral view of an embryo just before hatching. Green dots in the images are labeled as PGCs



15–30 min before the spawning time to prevent natural spawning in the original tank. To collect the sperm and ovulated eggs for artificial fertilization, anesthetize the fish with MS-222, and then place on a plastic sheet. To obtain the sperm, gently squeeze the abdomen of the male by hand, then collect the sperm with a pipette and dilute by 100 times with Hank's solution at 4 °C (Pandey et al. 2017b). In most cases, fish excrement appears before the sperm; wipe the excrement away before collecting the sperm. Sperm can be collected from the mature male at any time of day. However, Japanese anchovy sperm have a time-specific activation (circadian rhythm). Therefore, the best time to collect sperm with the highest mobility and movement velocity for fertilization is at spawning time. To collect the ovulated eggs, push the abdomen of the female and squeeze gently. Collected eggs should be kept in a 90 mm dish with a lid to prevent them drying out before fertilization. Mix the ovulated eggs with the diluted sperm in a container, then add seawater to activate the sperm and wait for 5 min. Remove the seawater from the container, add FSW supplemented with 0.01% streptomycin and penicillin, and incubate. Keep a maximum of a few hundred eggs in a 1 L beaker to avoid embryo deformity and delaying embryonic development.

The external appearance of each embryonic development stage is shown in Fig. 11.4. The developmental time described here for each stage is determined from the 1-cell stage. After fertilization, cytoplasmic movement begins and the formation of the blastoderm takes about 45 min at 16 °C, 40 min at 22 °C, and 33 min at 26 °C. The highest blastoderm with a flattened bottom is defined as the 1-cell stage. Cleavages repeat about every 15 min at 24 °C until the early blastula stage. It is noteworthy that the bottom of the blastoderm is slightly slanted in the embryo at the



**Fig. 11.4** External appearance of each embryonic development stage in Japanese anchovy, *Engraulis japonicus*. The (a) 4-cell, (b) 16-cell, (c) 128-cell, (d) 512-cell, (e) sphere, (f) germ ring, (g) 50% epiboly, (h) 100% epiboly, (i) 17–18-somite, (j) 32-somite, (k) pre-hatching, and (l) hatching stages

64-cell stage. The reason for this nonuniform shape and its developmental importance are unknown. The YSL formation is a good indicator for the embryonic staging of the blastula period in Japanese anchovy, as reported in other species. Because of the transparent body, the somites are difficult to determine during epiboly. The earliest somite observed here was in the 9-somite stage at 90% epiboly. Some of the embryos were hatched at 23 h 45 min at 24 °C and all embryos were hatched at 26 h.

### 11.3.2 Pacific Herring (Adhesive, Demersal Eggs)

Mature Pacific herring (*Clupea pallasii*) are caught around the northern coasts of the Pacific Ocean from winter to early spring. In nature, they scatter eggs and sperm in the seaweed beds of shallow seas, near to the coast. We obtain fish from the National Center of Stock Enhancement, Akkeshi, Hokkaido, Japan. It will likely be possible to obtain mature fish from a local fish market or fishermen. In our experience, it is possible to obtain eggs and sperm that are capable of fertilization from the fish in a fish market if they are caught on the same day as the experiment and kept on ice.

Fish must be kept on ice until use. You can easily distinguish between female and male by pushing their belly if they are fully matured: females and males will ooze yellowish eggs and white milt from their genital pores, respectively. To obtain eggs, squeeze a female abdomen while positioning its genital pore over a polypropylene sheet-lined plastic dish. Generally, you can obtain a lot of eggs from a single female, but in most cases 1 g of eggs is more than enough for experiments in the laboratory. The eggs need to be covered with the polypropylene sheet by folding it in order to avoid them drying out. Sperm are also obtained in a similar fashion, by squeezing the abdomen of the male. We used a 15 or 50 ml centrifuge tube for storage. The eggs and sperm must be kept on ice until use. In our experience, they keep their fertilization capability for several hours in this condition, but we did not test the limits of this. The dry method can be used to perform artificial fertilization. Transfer a small amount of eggs (100–200 eggs) to a new polypropylene sheet with a plastic tea spoon, add a small amount of sperm (1–5  $\mu$ l), and mix gently with the spoon. After that, place the mixture in FSW in a plastic dish (90 mm) and mix instantly so that they spread throughout the dish. The egg chorions of herring are very sticky and strongly adhere to the wall and bottom of the plastic dish just after transfer. Incubate at 4 °C in an incubator for 10 min and replace the fertilization solution twice with pre-chilled seawater to remove the excess sperm.

The stickiness of the eggs can be removed by incubating them with 1% urea and 0.1% trypsin in FSW for a few hours at 4 °C (Saito et al. 2006). With this treatment, the egg chorions become thin and the stickiness is removed, although the eggs remain attached to the bottom of the dish. After the treatment, replace the urea/trypsin solution with FSW three times. The microinjection of a solution, such as GFP-*nos3* 3'UTR mRNA, to visualize primordial germ cells (as described by Saito et al. 2006), will be possible after the de-stickiness treatment. For the microinjection, eggs should be attached to the central part of the plastic dish, preventing the vertical wall of the dish disturbing the approach of the needle to the eggs. Herring eggs contain 'yolk granules' rather than a single yolk, and the cytoplasm moves toward the animal pole as the embryo develops, so the solution can be injected into any part of the yolk at the 1- to 2-cell stage (Goto et al. 2019).

The embryonic development of the herring is very slow compared to that of model fish species, such as zebrafish and medaka. The embryo can be kept at a range of 3.5–15 °C (Kawakami et al. 2011), while replacing the FSW daily. Increasing the temperature accelerates the speed of embryonic development. Thus, it is relatively easy to adjust the developmental stage to your experiment/lecture plan, although there is no information about the speed of embryonic development for specific temperatures. Although it is slightly difficult, embryos can be dechorionated using a pair of fine forceps after the early somitogenesis period. Dechorionated embryos should be placed on an agar-coated (1% in seawater) dish filled with FSW supplemented with antibiotics (0.01% penicillin and 0.01% streptomycin) to prevent being damaged by the hard bottom of the dish. After the mid-somitogenesis period, the embryos will start to move. For photography and observation, you can add tricaine solution to the FSW at the same dose as the experiment for zebrafish (400 mg/100 ml).

### 11.3.3 Smelts (Adhesive Membrane, Demersal Eggs)

During the spawning season (spring), mature pond smelts can be obtained from river mouths at night. In Japan, eggs from the following four related species belonging to Osmeriformes are available for artificial fertilization: ayu (*Plecoglossus altivelis*), wakasagi (*Hypomesus nipponensis*), kyuriuo (*Osmerus mordax dentex*), and capelin (shishamo) (*Spirinchus lanceolatus*). Mature fish of kyuriuo can be also collected during the spawning season in Hokkaido, while ayu and shishamo cannot, because they are commercially important species. As several prefectural fisheries experimental stations propagate ayu seedlings, refer to your local stations.

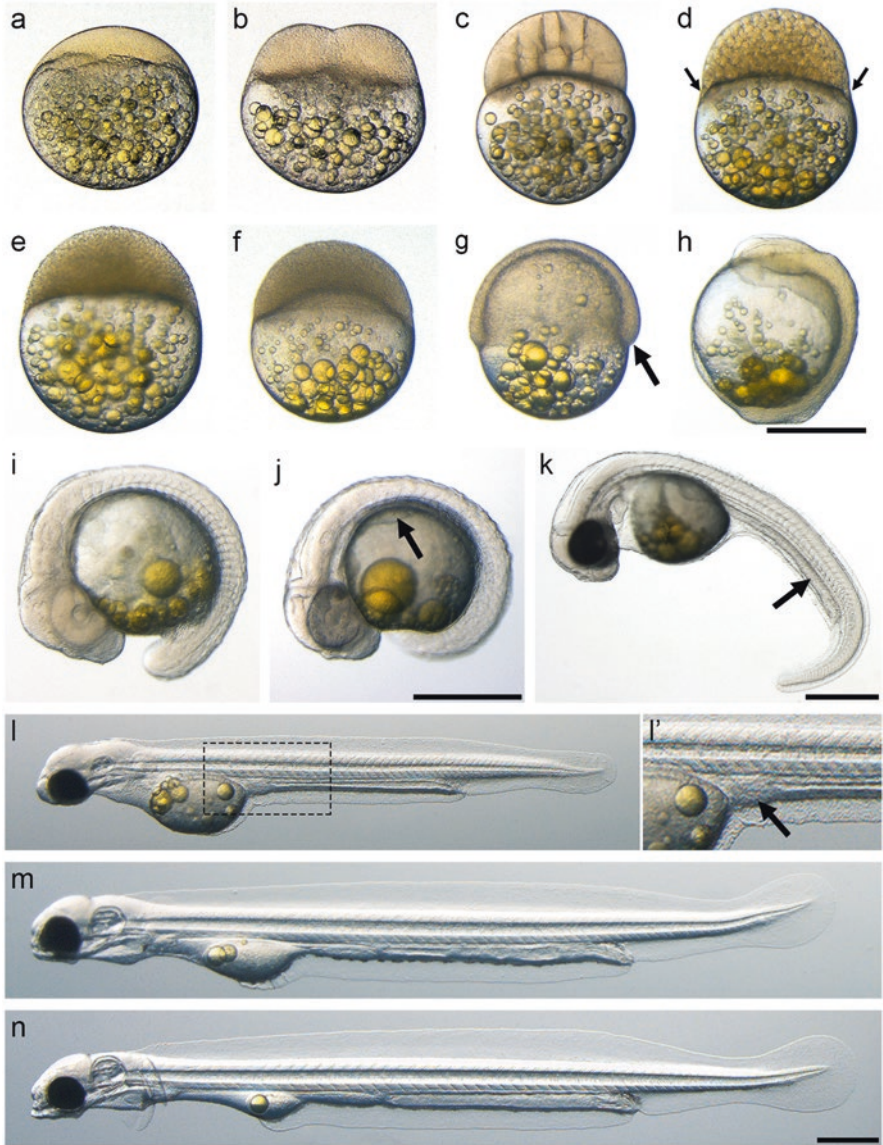
The collection of gametes and their fertilization are carried out by the dry method, the same as for Pacific herring. Inseminated eggs are scattered in a Petri dish filled with tap water. In this condition, fertilized eggs can be cultured under wide temperature conditions around 0–18 °C. Therefore, the rate of embryogenesis can be controlled by the culture temperature. Fertilized eggs can be dechorionated by treatment with 15 ml of smelt's Ringer's solution (SRS) containing 0.1% trypsin and 100 µl of 1 N NaOH for 1 min, followed by 30 ml of SRS containing 0.1% trypsin without NaOH. Three hours after treatment, the chorions of almost all of the eggs were removed. Therefore, the injection of artificial materials and operation of the embryo are possible for these denuded eggs. Please refer to Takahashi et al. (2016, 2017) for details of the experimental methods.

The embryonic development of pond smelt is shown in Fig. 11.5. During embryogenesis, the endodermal organs, e.g., the liver, pancreas, and digestive tract, can be easily observed because of the transparent body and late pigmentation. During the gonad formation, primordial germ cells first accumulate in the center of the body and then distribute asymmetrically as they interact with the endodermal organs. This characteristic makes pond smelt useful experimental animals because the interaction between the gonad and endodermal organs has not been studied in zebrafish due to their lack of stomach.

### 11.3.4 Ice Goby (Adhesive Threads)

The ice goby, *Leucopsarion petersii*, is a goby species that inhabits the inshore areas of Japan and Korea. They undertake anadromous migration to spawning in rivers from January to June. They are thought to be neotenic; they retain their larval form (transparent body, swim bladder, no scales, and a small pelvic fin) even when they reach the sexually mature stage. They spawn eggs on the top of small rocks in rivers. In Japan, you can purchase the fish from local fish dealers or directly from fishermen. Adult ice gobies are captured by a four-armed scoop net during their migration upstream in the spawning season. If you purchase them from a remote location, you can ask the dealer to put them in a plastic bag with oxygen and send them by refrigerated courier service (4 °C).

It is possible to induce the final maturation artificially in the laboratory. First, after receiving the fish, separate the males and females into separate tanks according



**Fig. 11.5** External appearance of the embryonic development stages of pond smelt, *Hypomesus olidus*. (a) 1-cell, (b) 2-cell, (c) 16-cell, (d) mid-blastula, (e) sphere, (f) 30% epiboly, and (g) embryonic shield (arrow) stages. (h) Appearance of the embryonic body, (i) optic cup, and (j) pigmentation of eye. (k) Hatching, (l) 14 days post-fertilization (dpf), lateral line primordium observed. (l') Higher magnification of (l). (m) Liver formation 18 dpf. (n) Opening of anus

to their pigmentation patterns: females have a line of pigment on both sides of their belly (see Fig. 11.1 in Arakawa et al. 1999). Then, the males must be kept in darkness in freshwater for 2 weeks at 19 °C in order to induce gonadal maturation.

Regarding the females, inject 25 units of human chorionic gonadotropin (hCG) into the body cavity to induce ovulation and culture in freshwater at 19 °C. Within 10 days, the eggs in the ovarian sac became round and swollen; this is a sign of ovulation. Anesthetize some females in tricaine solution in freshwater, and gently squeeze the belly to obtain unfertilized eggs, collecting them on a polypropylene sheet. Then, cover the eggs with the polypropylene sheet by folding it to avoid them drying out until use. Because it is quite difficult to squeeze the milt from mature males due to their small testes size, they should be sacrificed for insemination using an overdose of anesthesia, such as tricaine or 2-phenoxyethanol. Remove the testes and mince them into small pieces in a small amount of Hank's solution (about 50 µl). Then drop the sperm solution onto the unfertilized eggs and activate the sperm by adding small amount of freshwater (100–200 µl).

After fertilization, the chorion absorbs water and elongates to form an eggplant shape. The chorion can be removed easily with a pair of fine forceps in Ringer's solution. The embryos are very fragile compared to those of cyprinid species, such as goldfish and zebrafish; thus, microinjection should be performed in Ringer's solution supplemented with 1.6% albumen (chicken egg white solution). This albumen–Ringer's solution mixture is expected to work as an antibiotic (because of the lysozyme in the albumen) and aid the recovery of the embryos from injection damage. The ice goby eggs contain “yolk granules” rather than a single yolk. Usually, the embryo develops normally without problem with a volume of injectant 1/10 of the diameter of the egg (Saito et al. 2006). The dechorionated embryos need to be cultured in the same solution until the completion of epiboly. Without the albumen solution, the dechorionated embryos will sometimes adhere to the bottom of plastic dishes for an unknown reason, which causes the rupture of the yolk ball. Most ice goby embryos show latitudinal cleavage at the third cleavage to form eight cells, as seen in frogs and sea urchin embryos. Thus, it is possible to divide the tiers of blastomeres by using a fine glass-fiber needle and culturing them to study the function of the embryonic patterning determinants (Saito et al. 2002). For culturing embryos, temperature of 15–22 °C seems sufficient, although there is no literature confirming this. The normal developmental stages of ice goby are described in Arakawa et al. (1999).

### 11.3.5 Goldfish and Zebrafish (Adhesive, Demersal Egg)

Sperm are collected using an automatic micropipette with a crystal tip or glass capillary from anesthetized mature males of zebrafish or goldfish, respectively, and diluted with artificial seminal plasma at appropriate concentrations. Mature eggs are striped onto vinylidene chloride film and inseminated with diluted sperm. Inseminated eggs are scattered into the fertilization solution, tap water for zebrafish or urea water for goldfish, for fertilization. Fertilized eggs are easily dechorionated by using freshwater Ringer's solution containing 0.1% trypsin and 0.2% urea at about pH 7.0, adjusted using NaOH solution. Urea is not always required, but pH is an important factor for dechoriation in zebrafish. Goldfish chorions cannot be

removed without urea either in fertilization or dechoriation solution. Dechorionated eggs are incubated in 1% agar-coated Petri dishes filled with fresh-water Ringer's solution containing 1.6% albumin from chicken egg whites until the end of epiboly. Then, embryos can be cultivated in 1% agar-coated Petri dishes filled with 1.8 mM  $\text{CaCl}_2$  and 1.8 mM  $\text{MgCl}_2$  solution.

The embryonic stages of zebrafish and goldfish are precisely described in Kimmel et al. (1995) and Tsai et al. (2013), respectively. The simple developmental appearance of each stage for goldfish is shown in Fig. 11.6. As zebrafish embryos are highly transparent, the morphological changes are clearly observable during development. However, the optimal temperature for development is relatively limited; therefore, it is difficult to show the rich variety of developmental stages in student experiments over a limited time. In contrast, goldfish embryos can develop under a wide range of temperature conditions, from 10 to 30 °C, and thus it is possible to show these developmental stages to students. We cultured fertilized goldfish eggs at 10–24 °C condition and prepared the various developmental stages.

---

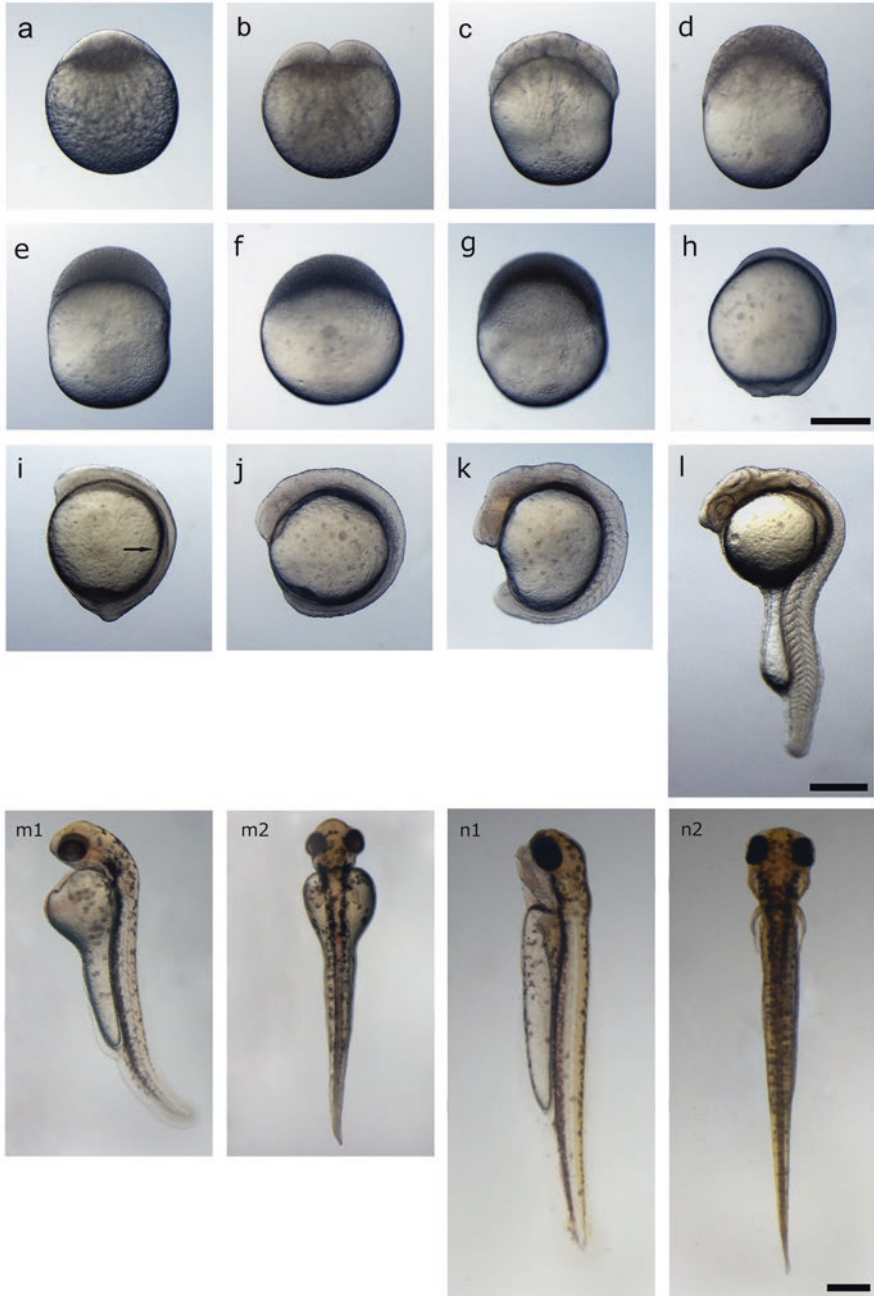
## 11.4 Observation and Experimental Analysis for Developmental Mechanisms

### 11.4.1 Cell Lineage

Cell labeling is useful for lineage tracing during development. For labeling, prepare an injection needle, from which a small amount of FITC solution is streaming out constantly, and settle its tip just at the surface of a single blastomere after the 64-cell stage in zebrafish and goldfish, and after the 8-cell stage in ice goby. After setting, tap the back of the needle holder gently, resulting that small amounts of fluorescent reagent is injected into the cell to label it (Fig. 11.7a). Descendants from a single-labeled cell can be traced thereafter under a fluorescence microscope. In the case of zebrafish, they begin to scatter after the beginning of epiboly, while in goldfish, they do so after the late-blastula stage (Fig. 11.7b). In goldfish, the labeled blastomeres begin to move just after the mid-blastula stage.

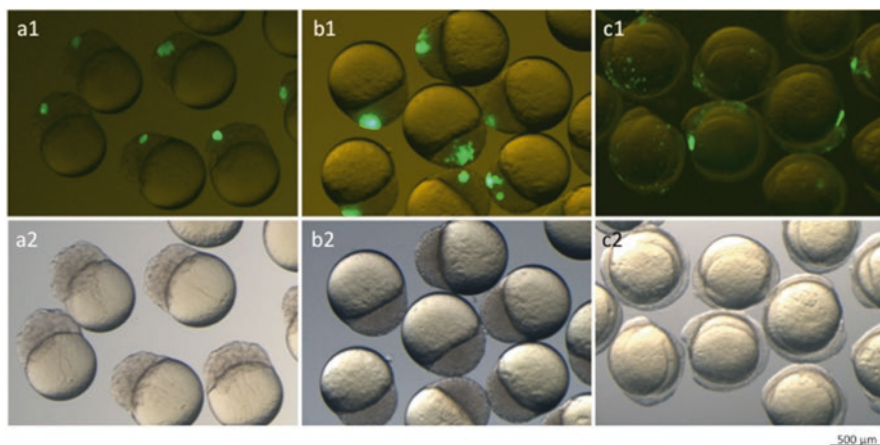
### 11.4.2 Showing YSL Function by Surgical Operation

Experimental embryology, such as experimental extirpation, has revealed the mechanisms controlling individual development by means of experiments on living organisms. It uses methods such as the marking, removal, transplantation, and isolation of body parts and organs. In some cases, these methods easily induce drastic morphological changes in development, disclosing the fundamental mechanisms of development. This is useful to raise the students' interest for development. In this sub-section, we describe an experiment to visualize YSL function during early development as an example of experimental embryology.



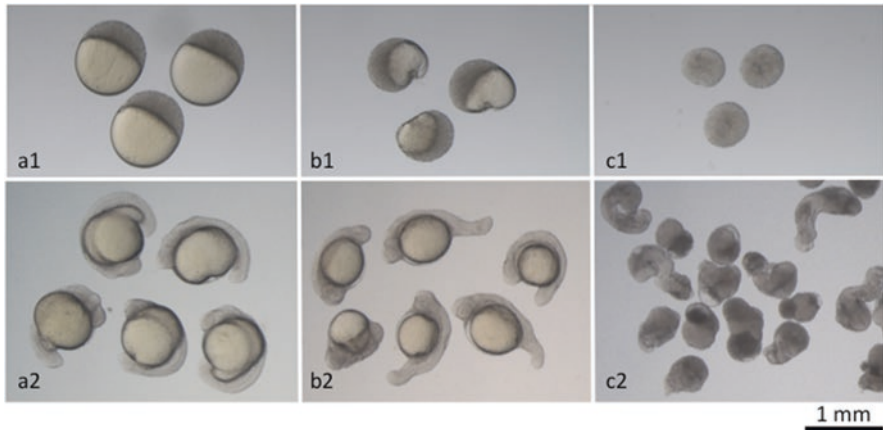
**Fig. 11.6** External appearance of the embryonic development stages of goldfish, *Carassius auratus*. (a) 1-cell, (b) 2-cell, (c) 64-cell, (d) mid-blastula, (e) oblong, (f) sphere, (g) 50% epiboly, (h) 100% epiboly, (i) 2-somite, (j) 8-somite, (k) 17-somite, and (l) 30-somite stages. (m1, m2). Lateral and dorsal view of heartbeat, and (n1, n2) lateral and dorsal view of hatching (by courtesy of Mr. Hirotarō Urushibata)





**Fig. 11.7** Cell labeling and tracing in zebrafish. (a) Immediately after injection with FITC into the upper tier of blastomeres. (b) Results at the mid-blastula stage. Descendants of labeled cells begin to scatter in some blastulae. (c) Results at 100% epiboly. Descendants of labeled cells scatter in the embryos. (a1–c1) Fluorescent view. (a2–c2) Backlight view

For the surgical operation, prepare a dissecting needle with thin glass-wool attached to the top (SD2) and an agar plate, such as a 90 mm glass dish filled with a 1 mm layer of 1% agar in Ringer's solution. Transport the blastulae without chorions to the agar plate filled with an appropriate amount of Ringer's solution. Two types of operation are performed in the blastulae using a dissecting needle. First is the isolation of the blastoderm from the yolk cell. Cut off the blastoderm from just above the yolk cell. The resultant blastoderm form a spherical cell-mass covered with an enveloping layer (Supplemental Movie 11.2). Second is the removal of yolk by injuring the yolk membrane or cutting off the vegetal yolk hemisphere. After healing the injury, the resultant embryos are small yolk cells covered with large blastoderms (Supplemental Movie 11.3). These two types of operated embryos and a control (without operation) are cultured independently in separated wells of a culture plate filled with the appropriate culture medium. In the case of zebrafish, freshwater Ringer's solution containing 1.6% albumin from egg white is used for the operation and as a cultivation medium for 1 day after the operation. After the completion of epiboly, the denuded eggs are cultured in a simpler culture medium; for zebrafish and goldfish, freshwater containing 1.8 mM  $\text{CaCl}_2$  and 1.8 mM  $\text{MgCl}_2$  is sufficient for cultivation. When the surgical operation is carried out at around the blastula stage, the functions of YSL are visualized in the morphology of the resultant embryos (Fig. 11.8). The separated blastoderm, from which the yolk cell is removed just after the mid-blastula transition, develops a rotationally symmetrical embryo. At the late-blastula stage, it develops abnormal embryos with segmented tissues and without the anterior differentiation of the brain. Separated embryos with a partial YSL and a small amount of yolk, which have recovered from the injury to the yolk cell, develop as almost normal embryos with optic vesicles. These results



**Fig. 11.8** Surgical operation at the blastula stage in zebrafish (**a1**, **b1**, **c1**) and the resultant embryos at the tail bud stage (**a2**, **b2**, **c2**). (**a1**, **a2**) Control embryos without extirpation of the yolk. (**b1**, **b2**) Operated embryos with extirpated vegetal half of yolk cell. (**c1**, **c2**) Operated embryos without yolk cell. This operation indicates the function of yolk cells with a YSL

suggest that yolk cells with a YSL induce the differentiation of the blastoderms gradually after the mid-blastula stage, and are required for normal development. This type of experiment is applicable to other species if the chorions are removable from the embryos.

### 11.4.3 PGC Visualization and Migration

The teleost germplasm and PGCs are visualized by injecting artificial mRNA, such as *bucky ball*-GFP mRNA and GFP-*nos3* 3'UTR mRNA, respectively, into the egg cytoplasm just after fertilization (Saito et al. 2008). Germplasm begin to visualize during the early cleavage stage along the ends of the cleavage furrows and the connected side between the upper and lower blastomeres (Fig. 11.3b, c). These signals disappear after the blastula stage. PGCs begin to visualize after the gastrula stage by GFP-*nos3* 3'UTR mRNA (Fig. 11.3d). Not all PGCs are always visualized by artificial mRNA; it is dependent on the distribution of the solution. The fluorescence strength of each PGC is different even in a single embryo, while auto-fluorescence is observed in somatic cells around the PGCs.

## 11.5 Conclusion

Recently, gene editing has attracted public attention, because of the easy modification of specific genes and rapid improvements to genetic breeding. Many marine teleosts, which are recognized as important species from a commercial viewpoint, have been gene-edited in order to introduce extraneous characters that are expected

to be useful in various applications for aquaculture. On the other hand, early-stage mortality is very high in marine teleosts. A limited number of modified embryos should be handled with care and grown to maturity. Therefore, handling techniques and observation abilities are required for researchers in this field. Marine stations are essential places for training to improve these techniques and abilities.

### Solutions

Artificial seminal plasma (zebrafish, goldfish, common carp, and other cyprinid fish): NaCl 5.61 g, KCl 5.23 g, CaCl<sub>2</sub>·2H<sub>2</sub>O 0.33 g, MgCl<sub>2</sub>·6H<sub>2</sub>O 0.22 g, and NaHCO<sub>3</sub> 0.2 g/L DW.

Urea water (fertilization solution for goldfish): 0.2% urea and 0.24% NaCl in tap water.

Dechoriation solution (goldfish and zebrafish): 0.1% trypsin and 0.2% urea in freshwater Ringer's solution maintained at about pH 7.0 (adjusted by NaOH solution).

Culture solution for dechorionated eggs: Ringer's solution containing 1.6% albumin from egg-white precipitate.

Freshwater Ringer's solution: 128 mM NaCl, 2.8 mM KCl, and 1.8 mM CaCl<sub>2</sub>.

SRS: 128 mM NaCl, 2.8 mM KCl, and 2.7 mM CaCl<sub>2</sub>.

Dechoriation solution for smelts: SRS containing 0.1% trypsin and 100 µl of 1 N NaOH.

---

### References

- Arakawa, T., Kanno, Y., Akiyama, N., et al. (1999). Stages of embryonic development of the ice goby (Shiro-uo), *Leucopsarion petersii*. *Zoological Science*, 16(5), 761–773.
- Funamoto, T., Aoki, I., & Wada, Y. (2004). Reproductive characteristics of Japanese anchovy, *Eugraulis japonicus*, in two bays of Japan. *Fisheries Research*, 70, 71–81.
- Goto, R., Saito, T., Kawakami, Y., et al. (2015). Visualization of primordial germ cells in the fertilized pelagic eggs of the barfin flounder *Verasper moseri*. *International Journal of Developmental Biology*, 59(10–12), 465–470.
- Goto, R., Saito, T., Matsubara, T., & Yamaha, E. (2019). Microinjection of marine fish eggs. *Methods in Molecular Biology*, 1874, 475–487.
- Guyomard, R., Chourrout, D., Leroux, C., et al. (1989). Integration and germ line transmission of foreign genes microinjected into fertilized trout eggs. *Biochimie*, 71, 857–863.
- Ito, Y., Sakai, H., Kondo, M., et al. (1999). Development of denuded eggs of common carp. *Suisanzosyoku*, 47(2), 257–261.
- Iwamatsu, T. (1988). A new technique for dechoriation and observations on the development of the naked egg in *Oryzias latipes*. *Developmental Biology*, 228(1), 83–89.
- Kawakami, T., Okouchi, H., Aritaki, M., et al. (2011). Embryonic development and morphology of eggs and newly hatched larvae of Pacific herring *Clupea pallasii*. *Fisheries Science*, 77, 183–190.
- Kimmel, C. B., Ballard, W. W., Kimmel, S. R., et al. (1995). Stages of embryonic development of the zebrafish. *Developmental Dynamics*, 203, 253–310.
- Kimmel, C. B., & Low, R. D. (1985). Cell lineage of zebrafish blastomeres III. Clonal analyses of the blastula and gastrula stages. *Developmental Biology*, 108(1), 94–101.

- Pandey, D., Ryu, Y. W., Goto, R., & Matsubara, T. (2017b). Morphological and biochemical changes in oocytes during final oocyte maturation in Japanese anchovy (*Engraulis japonicus*). *Aquaculture Science*, 65(1), 29–40.
- Pandey, D., Ryu, Y. W., & Matsubara, T. (2017a). Features of sperm motility and circadian rhythm in Japanese anchovy (*Engraulis japonicus*). *Fisheries and Aquaculture Journal*, 8, 2. <https://doi.org/10.4172/2150-3508.10000203>
- Saito, T., Fujimoto, T., Maegawa, S., et al. (2006). Visualization of primordial germ cells *in vivo* using GFP-*nos1* 3'UTR mRNA. *International Journal of Developmental Biology*, 50, 691–700.
- Saito, T., Goto-Kazeto, R., Arai, K., & Yamaha, E. (2008). Xenogenesis in teleost fish through generation of germ-line chimeras by single primordial germ cell transplantation. *Biology of Reproduction*, 78, 159–166.
- Saito, T., Goto-Kazeto, R., Fujimoto, T., et al. (2010). Inter-species transplantation and migration of primordial germ cells in cyprinid fish. *International Journal of Developmental Biology*, 54, 1481–1486.
- Saito, T., Goto-Kazeto, R., Kawakami, Y., et al. (2011). The mechanism for primordial germ-cell migration is conserved between Japanese eel and zebrafish. *PLoS One*, 6(9), e24460.
- Saito, T., Otani, S., Nagai, T., et al. (2002). Germ cell lineage from a single blastomere at 8-cell stage in shiro-uo (ice goby). *Zoological Science* 19(9):1027–1032.
- Saito, T., Pšenička, M., Goto, R., et al. (2014). The origin and migration of primordial germ cells in sturgeons. *PLoS One* 9(2), e86861.
- Sakai, Y. T. (1961). Method for removal of chorion and fertilization of the naked egg in *Oryzias latipes*. *Embryologia*, 5, 357–368.
- Takahashi, E., Kawakami, Y., Arai, K., & Yamaha, E. (2016). Dechoriation of fertilized eggs and embryonic development in arctic rainbow smelt *Osmerus eperlanus mordax*. *Fisheries Science*, 82, 639–652.
- Takahashi, E., Shimizu, Y., Urushibata, H., et al. (2017). Migration behavior of PGCs and gonad formation in primitive Euteleostei fish: Pond smelt *Hypomesus nipponensis*. *International Journal of Developmental Biology*, 61(6–7), 397–405.
- Takasuka, A., Oozeki, Y., Kubota, H., et al. (2005). Temperature impacts on reproductive parameters for Japanese anchovy: Comparison between inshore and offshore waters. *Fisheries Research*, 76(3), 475–482.
- Tsai, H. Y., Chang, M., Liu, S. C., et al. (2013). Embryonic development of goldfish (*Carassius auratus*): A model for the study of evolutionary change in developmental mechanisms by artificial selection. *Developmental Dynamics*, 242(1), 1262–1283.
- Yamaha, E., Usui, K., Onozato, H., & Hamada, K. (1986). A method of dechoriation in goldfish, *Carassius auratus*. *Nippon Suisan Gakkaishi*, 52(11), 291–298.
- Yoneda, M., Kitano, H., Selvaraj, S., et al. (2013). Dynamics of gonadosomatic index of fish with indeterminate fecundity between subsequent egg batches: Application to Japanese anchovy *Engraulis japonicus* under captive conditions. *Marine Biology*, 160, 2733–2744.
- Yoneda, M., Yamamoto, M., Yamada, T., et al. (2015). Temperature-induced variation in sexual maturation of Japanese anchovy. *Journal of the Marine Biological Association of the United Kingdom* 95(6):1271–1276.
- Yoshizaki, G., Oshiro, T., & Takashima, F. (1989). Preventing of hardening of chorion and dechoriation for microinjection into fish eggs. *Nippon Suisan Gakkaishi*, 55, 369.



# Development of Marine Macroalgae

# 12

Chikako Nagasato, Atsuko Tanaka, Kensuke Ichihara,  
and Taizo Motomura

## Abstract

Seaweeds include brown, green, and red algae. Their basic life cycle involves the alternation of generations between gametophytes and sporophytes. These two generations are mediated by sexual and asexual reproduction. The reproductive cells of seaweeds are released into the seawater without any support cells or tissues, easily allowing us to perform experiments and observe their different developmental stages. In this chapter, we introduce three experimental models for fertilization. First, we explore the zygotes of furoid brown algae as a model for asymmetrical cell division. Second, we look at the fertilization of *Ulva* species in green algae. In this example, gametes have two flagella and move towards a light source. In contrast, zygotes have quadriflagella and move in the opposite direction, away from a light source. Last, we examine the red alga, *Palmaria palmata*. The life cycle of this species is unique among red algae, and we explain the procedures necessary for obtaining a small female gametophyte and inducing fertilization. These three species are easy to handle and effectively demonstrate the different fertilization processes through these experiments. In preparation for conducting these experiments, it is important to understand the maturation period for each specimen and to obtain fresh material from the field.

---

C. Nagasato (✉) · K. Ichihara · T. Motomura  
Muroran Marine Station, Hokkaido University, Sapporo, Japan  
e-mail: [nagasato@fsc.hokudai.ac.jp](mailto:nagasato@fsc.hokudai.ac.jp)

A. Tanaka  
Faculty of Science, University of the Ryukyus, Nishihara, Japan

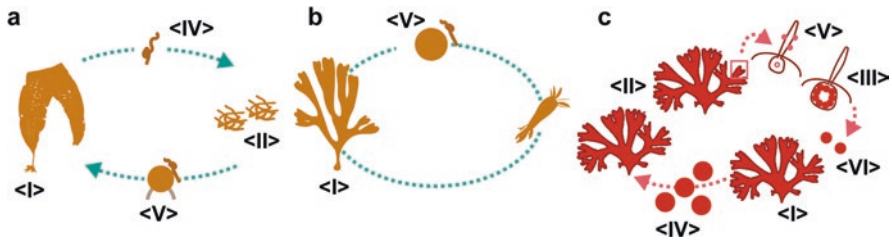
## 12.1 Overview

Seaweeds are macroscopic multicellular marine algae. They are divided into three groups (green, red, and brown algae) depending on their photosynthetic pigments (Fig. 12.1). Thousands of species have been described, including 1500 green algae, 6500 red algae, and 2000 brown algae (<http://www.seaweed.ie/index.php>). The main photosynthetic pigments are Chl *a* and *b* in green algae, Chl *a* in red algae, and Chl *a* and *c* in brown algae.

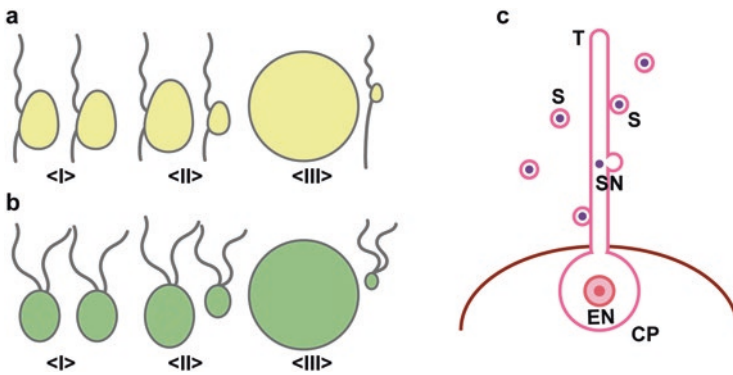
Seaweeds have life cycles that can be divided into haploid (only gametophytes), diploid (only sporophytes), and a combination of haploid and diploid (Fig. 12.2). When gametophytes and sporophytes are morphologically identical or different, the life history is referred to as isomorphic or heteromorphic, respectively. Red algae can have triphasic generations including sporophytes, gametophytes, and carposporophytes, which are diploid and live on the gametophyte. Large kelp (brown algae in the Laminariales) are sporophytes and the gametophytes are tiny filamentous thalli. Therefore, the life history of kelp clearly shows heteromorphic alternation between generations. *Sargassum* and *Fucus* (both brown algae) have diploid life histories, as they are sporophytes without gametophytes. The sporophytes and gametophytes of *Dictyota* (brown algae), *Ulva* (green algae), and *Enteromorpha* (green algae) have the same size and morphology. Both sexual and asexual reproduction occur in seaweeds, with a great diversity in the morphology of reproductive cells.



**Fig. 12.1** Various colored seaweeds in Muroran, Hokkaido, Japan (August). Brown algae (*Saccharina japonica*), green algae (*Ulva australis*), and red algae (*Neodilsea yendoana*, *Odonthalia corymbifera*). (Photo by Dr. Hiromori Shimabukuro, National Research Institute of Fisheries and Environment of Inland Sea, Fisheries Research Agency)



**Fig. 12.2** Seaweed life histories (a) Life history of *Saccharina* (heteromorphic, diplohaplontic alternation of generations). (b) Life history of *Fucus* (diploid). (c) Life cycle of *Chondrus* (triphasic life history). <I>: sporophyte, <II>: gametophyte, <III>: carposporophyte, <IV>: asexual reproductive cell (zoospore in *Saccharina* and tetraspore in *Chondrus*), <V>: sexual reproduction, <VI>: carpospore



**Fig. 12.3** Patterns of sexual reproduction among seaweeds. (a) Brown algae, (b) green algae, and (c) red algae. I: isogamy, <II>: anisogamy, <III>: oogamy. CP carpogonium, EN egg nucleus, S spermatium, SN spermatium nucleus, T trichogyne

## 12.2 Seaweed Reproduction

Sexual reproduction produces genetic variation in populations by fusing together genes from different parents. When male and female gametes have the same morphology and size this is called isogamy. In anisogamy female gametes become larger than male gametes, in oogamy there are motile sperm and non-motile eggs (Fig. 12.3). Red algae lack flagella so their reproductive cells are not able to move actively. In green algae, male and female gametes usually have two equal-length flagella (isokont), whereas brown algal gametes have two unequal-length flagella (heterokont). Gametes-bearing flagella of brown and green algae have phototaxis and/or chemotaxis to increase fertilization success. When male and female gametes fuse, a cell wall is synthesized just after fertilization. This differs from higher plants, in which fertilization is carried out by pollen and egg cells that are embedded in ovules. Sexual reproduction in red algae occurs only through oogamy, and fertilization in this group differs from that in brown and green algae. In red algae, male

gametes float until they encounter female gametophytes. Both male and female reproductive cells in red algae are not naked, but are covered with a mucilaginous cell wall; therefore, recognition and first contact must be carried out with these coverings.

In this chapter, we introduce procedures for inducing the release of gametes and gamete fusion in a laboratory setting to observe fertilization and track development. For this, we selected *Fucus* (brown algae), *Ulva* (green algae), and *Palmaria palmata* (red algae), for which fertilization occurs relatively easily in the laboratory.

---

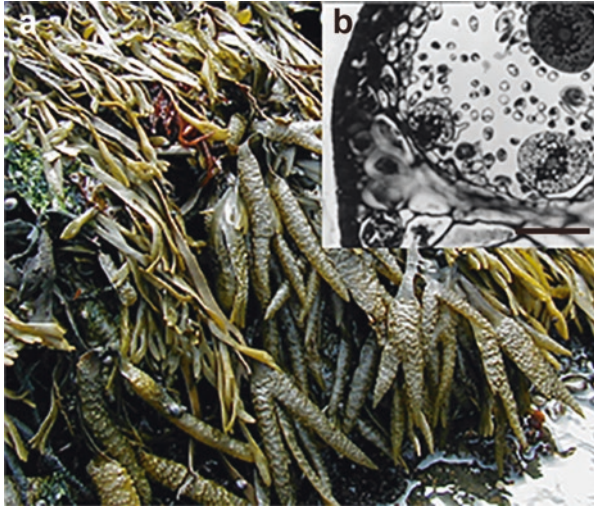
### 12.3 Experiment 1: Fertilization of Brown Algae (*Fucus*)

Three types of fertilization (isogamy, anisogamy, and oogamy) have been reported in brown algae. The maturation of the gametangium, which is seasonally induced by photoperiod and water temperature, and the timing of gamete release must be synchronized for successful fertilization. The fusion of gametes in seawater occurs as follows: female gametes (eggs) settle on the substratum and secrete pheromones, male gametes are attracted and cell fusion occurs. Following the release of gametes, fertilization is performed outside of the parent tissue, which makes studying fertilization and zygote development easier. *Fucus* zygotes have been used as a model system to study the fertilization and development of oogamous species for more than 100 years. Unequal cell division is an important event that occurs during primary zygote development, as the fate of each daughter cell is usually decided at this moment. The primary developmental axis causes unequal cell division by participating in the rearrangement of cytoplasm. Understanding zygote development is crucial to understand biological development.

*Fucus* zygotes possess some advantages for studying development: (1) large populations of zygotes can be obtained synchronously, (2) primary developmental axes can be experimentally manipulated during the initial hours of development, and (3) unilateral light can be used to induce polarization. Despite these advantages, problems with culturing and maturing *Fucus* zygotes in laboratory settings restrict their use in seasonal and local studies of natural thalli (Fig. 12.4). *Fucus* eggs are spherical and once a sperm fertilizes an egg, the zygote forms a rhizoid within 16 h. When zygotes are incubated in a culture chamber with unilateral light, large populations of fertilized eggs synchronously develop rhizoids from the shaded sides of the zygotes (Fig. 12.5). This shows that a primary embryonic axis is established during the initial hours and unilateral light induces polarization.

Following rhizoid formation, cell division occurs unequally and the dividing plane is formed perpendicular to the rhizoid's elongating axis. Unequal cell division causes daughter cells to develop into either thallus or rhizoid cells. Generally, unequal cell division is defined as cell division that creates two daughter cells possessing distinct appearances, properties, or fates. Cell polarity, which is the biased distribution of cell components (such as organelles, ions, and nucleic acids), is thought to contribute to unequal cell division.





**Fig. 12.4** Mature thalli of *Fucus distichus* in Muroran, Hokkaido, Japan. (a) Receptacles at the distal tips of thalli. (b) A section of conceptacle containing several oogonia and antheridia shown as dots on the thallus surface. Scale bar is 100  $\mu$ m



**Fig. 12.5** Rhizoid development of zygotes under uniform light

In this chapter, we observe the development of *Fucus* zygotes and attempt to identify when the position of rhizoid formation is determined by unilateral light.

### Methods

1. After washing mature *Fucus* thalli with distilled seawater, gently remove seawater on the surface of the thallus with a cotton gauze.

2. Incubate several thalli in a high-walled Petri dish at 18 °C with continuous light overnight.
3. Two hours before use, cover the Petri dish with foil or black cloth and keep it in a cooling chamber at 5 °C.
4. Pour cooled seawater into the Petri dish (Fig. 12.6). Eggs are released from the oogonia and sperm come out of the antheridia and start to swim around the egg. This can be recorded as the beginning of zygote development.
5. Replace distilled seawater repeatedly until the mucilage is removed. The zygote solution is now ready for the experiment.

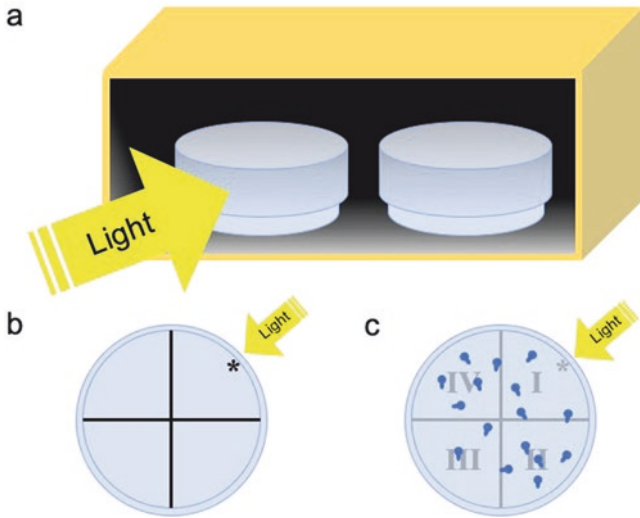
### Rhizoid Morphogenesis Polarized by Unilateral Light

This experiment aims to determine whether light is necessary for primary developmental axis formation and measure when polarization is fixed. The fate of the daughter cells is decided at the time of developmental axis fixation.

1. Make a dark box with one side opened prior to the experiment (Fig. 12.7).
2. Draw a cross on the bottom of a 35 mm plastic Petri dish and use the symbol to mark the section that will be initially illuminated with light (Fig. 12.7).
3. Prepare the other three Petri dishes as described in the previous step.
4. Mix the zygote solution with heated 0.5% agarose in distilled seawater (low-melting agarose is recommended) and rapidly pour 3 mL into each Petri dish.
5. The light conditions for incubation are shown below. Culture temperature should remain at 18 °C during incubation.
  - (a) Continuous unilateral light;

**Fig. 12.6** Induction of eggs and sperm release from receptacles of *Fucus distichus*. Scale bar is 2 cm





**Fig. 12.7** Preparing the experiment. (a) A dark box with one side opened. (b) Example of numbers clockwise on the bottom of a Petri dish for counting. (c) Example of germinated zygotes on a Petri dish

- (b) Continuous darkness;
  - (c) Orientate the Petri dish  $180^\circ$  after 12 h of incubation under unilateral light to change the illuminated side;
  - (d) Cover with foil to make the dish completely dark after 12 h of incubation under unilateral light.
6. After 24 h of incubation in total, observe the direction of rhizoid development in each condition using a stereomicroscope. The first illuminated section should be labeled <I> and other sections should be labeled in a clockwise direction as <II>, <III>, and <IV> (Fig. 12.7).
  7. Select 50 zygotes randomly in each condition and determine the direction of rhizoid elongation among the four sections to determine the influence of light.

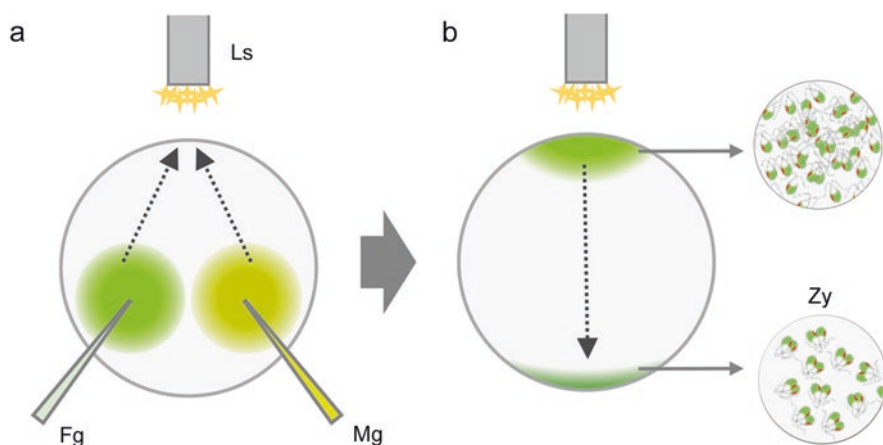
## 12.4 Experiment 2: Fertilization of Green Algae (*Ulva*)

Most species in the genus *Ulva* live in seawater, but some inhabit brackish and freshwater environments. *Ulva* species are characterized by distromatic flat and blade-like thalli (*Ulva* type) or monostromatic tubular thalli (*Enteromorpha* type) (Fig. 12.8). The life cycle is haplodiplontic and isomorphic (Fig. 12.8) (van den Hoek et al. 1995). There is little differentiation among tissues; all thallus cells are similar except for basal cells, which are elongated to form attachment rhizoids (rhizoidal cells).

It is easy to collect *Ulva* species during field surveys, as they grow on rocks in the middle to low intertidal zone. If the marginal region of the thallus is olive green



**Fig. 12.8** Morphology and life cycle of *Ulva* spp. (a) Distromatic flat thalli. (b) Monostromatic tubular thalli. (c) *Ulva* life cycle. <I>: gametophyte, <II>: sporophyte. <III>: gamete, <IV>: zygote, <V>: zoospore



**Fig. 12.9** Phototaxis of gametes and zygotes. (a) Male and female gametes show strong positive phototaxis. (b) Zygotes have negative phototaxis. *Ls* Light source, *Fg* Female gamete, *Mg* Male gamete, *Zy* Zygote

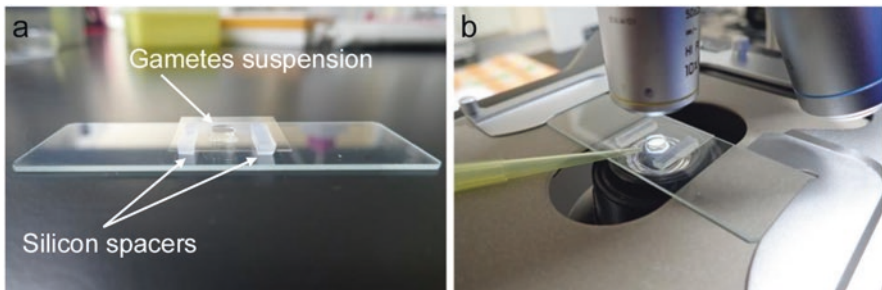
to brownish green, this area includes mature cells. In the mature area of the thallus, vegetative cells undergo mitotic or meiotic division and form 8–128 motile reproductive cells (Smith 1947). In general, male gametes are brownish green, whereas female gametes are yellowish green. The difference in colors depends on the size of each gamete, as the male gamete is slightly smaller than the female gamete (anisogamy). *Ulva* zoospores usually show negative phototaxis, as they swim away from light sources. Gametes show strong positive phototaxis, swimming toward light sources (Fig. 12.9). The fertilization reaction starts immediately after male and female gametes are mixed. Mixed gametes form cell clusters and touch the tips of their flagella (Miyamura 2004). Paired gametes then immediately leave the cell cluster (Bråten 1971). The anterior ends of the gametes fuse within a few seconds and the flagella separate. After cell fusion, phototaxis reverses from positive to negative and the quadriflagellate zygote remains motile for a few minutes (Fig. 12.9). In this section, observational methods for zygote formation and the early-stage development of gametes, zygotes, and zoospores are described.

## Methods

1. Gamete collection method for samples collected from the field:
  - (a) Bring matured thalli to the lab and clean them with sterilized seawater and a brush.
  - (b) Place each matured thallus in a Petri dish filled with sterilized seawater and position it near a light source (e.g., LED light, desk lamp). Each reproductive cell should be released immediately.
  - (c) Examine the color and phototaxis of each reproductive cell to obtain the male and female gametes.
2. Induction of gamete formation using cultured materials based on Hiraoka and Enomoto (1998).
  - (a) Male and female gametophytes should be grown to a length of approximately 10 cm in an aerated 1 L flask filled with Provasoli's enriched seawater (PES) (Provasoli 1968).
  - (b) Cut each thallus into 5 mm<sup>2</sup> pieces and wash each piece two to three times with sterilized seawater in a Petri dish.
  - (c) The Petri dish should be kept at 22 °C with a 14:10 h L:D cycle under fluorescent light at 100 μmol photonsm<sup>-2</sup> s<sup>-1</sup>. PES should be replaced every day.
  - (d) After 2–3 days, the color of the thalli will change from green to yellowish or brownish green and gametes will have formed. Place matured thalli in Petri dishes near a light source and the gametes will be released 2–3 h later.
3. Collect the highly concentrated gamete or zoospore suspension using a Pasteur pipette or micropipette and add it to the other Petri dishes. Use sterilized seawater to wash each reproductive cell (repeating two or three times).

## Observing Fertilization and Zygote Formation

1. Place the male or female gamete suspension on a coverslip.
2. Place the coverslip on silicon or plastic spacers on a slide (Fig. 12.10).
3. Place the glass slide under a microscope and add the opposite sex's gamete suspension to the glass slide using a micropipette (Fig. 12.10).



**Fig. 12.10** Method for observing the fertilization of *Ulva* spp. under a microscope. (a) Silicon spacers placed between a glass slide and a coverslip. (b) Opposite-sex gamete suspension is added to the male or female gamete suspension using a micropipette

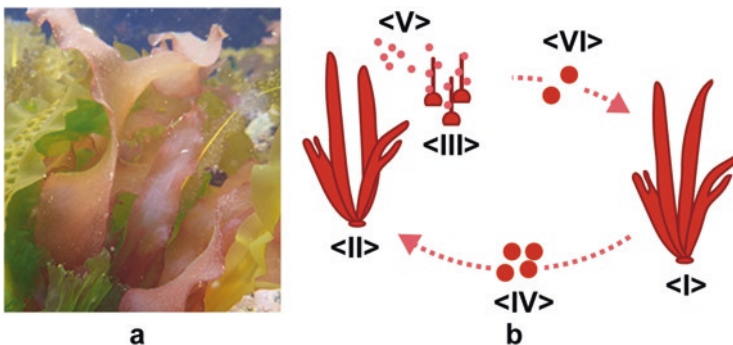
- The fertilization reaction should begin immediately. After 1–2 min, add the same volume of fixation buffer (e.g., 0.5–1% glutaraldehyde in sterilized seawater) to observe the zygotes.

### Observing the Early Developmental Stage of Each Reproductive Cell

- Place glass coverslips in Petri dishes filled with PES.
- Add the gamete, zoospore, or zygote suspension to the Petri dishes.
- Incubate Petri dishes overnight at 22 °C in the dark to allow the gametes or zygotes to settle on the coverslips.
- Place the coverslip on a glass slide, cover it with a larger coverslip, and observe the settled reproductive cells using a microscope.
- Keep the Petri dishes at 22 °C with a 14:10 h L:D cycle under fluorescent light at 100 mmol m<sup>-2</sup> s<sup>-1</sup>. The first cell division should occur within 2–4 days; observe it following step 4.

## 12.5 Experiment 3: Fertilization of Red Alga (*Palmaria palmata*)

Red algae are characterized by oogamous sexual reproduction. Spermium (plural: spermata) is the non-motile sperm of red algae and the egg nucleus is contained within the female's carpogonium (plural: carpogonia). In many cases, the carpogonium is surrounded by gametophyte tissue, which makes it difficult to observe the fertilization and development of the zygotic cell. Spermata move via wave motion to encounter a trichogyne, which is a fine strand projecting from the carpogonium (Fig. 12.3). Cell-to-cell recognition occurs on the surface of the trichogyne and spermium, both of which are covered with sugar proteins to assist in cell recognition (Kim et al. 1996). Spermium nuclei are not able to enter the trichogyne until



**Fig. 12.11** The life cycle of *Palmaria palmata*. (a) *Palmaria palmata*. (b) Life cycle. <I>: sporophyte, <II>: male gametophyte, <III>: female gametophytes, <IV>: tetraspores, <V>: spermata, <VI>: carpospores



**Fig. 12.12** Incubation of *Palmaria palmata* to induce the release of the tetraspores and sperm

recognition is successful. If the spermatia and trichogyne are matched, the cell wall of the trichogyne is digested. The nucleus then passes through the trichogyne and migrates towards the egg nucleus. Although several spermatium nuclei are able to move towards the trichogyne simultaneously (Wilson et al. 2002), the process behind the exclusion of excess male nuclei is not well understood.

*Palmaria palmata* is a suitable species for examining this problem further (Fig. 12.11). This alga has a characteristic isogamous life cycle, where the gametophytes and sporophytes are morphologically identical. While sporophytes and male gametophytes are macroscopic and morphologically identical, female gametophytes are smaller than male gametophytes (van der Meer and Todd 1980). Female gametophytes are dwarfed, and the carpogonia are not enclosed within the gametophyte tissue. In Japan, *Palmaria palmata* is distributed throughout Hokkaido and the north Pacific coast of Honshu, and the mature season is from winter to spring. Mature sporophytes have dark red spots on the blade, while mature male gametophytes have pale pink spots on the blade. The dark spots on the sporophytes are tetrasporangia, organs that produce tetraspores, and the pale pink spots are spermatangia, organs that produce spermatia. However, the identification of sporophytes and male gametophytes must be confirmed through microscopy. Here, the insemination of carpospores and spermatium and fertilization induction in *Palmaria palmata* are described (Mine and Tatewaki 1994).

### Methods

1. Collect mature thalli and separate the sporophytes and male gametophytes under a microscope.
2. Wash the thalli with sterilized seawater and place them on paper towels (Fig. 12.12).
3. Keep thalli at 10 °C in a dark room before use.
4. Cut 5 cm<sup>2</sup> sections of sporophyte thalli and place them in a 50 ml beaker.

5. Pour cooled sterile seawater into the beaker with the thalli piece and incubate on a rotary shaker for 1 h.
6. Prepare the filtrated seawater to be used for the release of tetraspores.<sup>1</sup>
7. Place coverslips on the bottom of the Petri dishes (6 cm diameter) and culture the washed spores in a PES medium (Provasoli 1968) under LED lamps (20–40  $\mu\text{mol photons m}^{-2}\cdot\text{s}^{-1}$ ) at 15 °C under long-day conditions (14:10 h L:D).
8. Check male and female gametophytes 2 days later. Female gametophytes have trichogynes and carposporangia.
9. Incubate 5  $\text{cm}^2$  of male gametophytes in a 50 ml beaker filled with seawater on a rotary shaker for 2 h.
10. Inseminate female gametophytes with the floating spermatia.

### Observations of Karyogamy and Mitosis

1. Transfer the coverslip with female gametophytes to the glass slide and cover it with the larger coverslip.
2. Fix female gametophytes with 1% glutaraldehyde in seawater for 1 h at 4 °C.
3. After rinsing, stain the samples with 0.5  $\mu\text{g mL}^{-1}$  4,6-diamidino-2-phenylindole (DAPI), a fluorescent stain that binds to the AT region of dsDNA, in seawater for 1 h.
4. Mount the rinsed samples onto glass slide. Use an excitation/emission wavelength combination of 360/460 nm to view the blue fluorescence of DAPI with fluorescence microscopy.

---

## References

- Bråten, T. (1971). The ultrastructure of fertilization and zygote formation in the green alga *Ulva mutabilis* Foy. *Journal of Cell Science*, 9, 621–635.
- Hiraoka, M., & Enomoto, S. (1998). The induction of reproductive cell formation of *Ulva pertusa* Kjellman (Ulvales, Ulvophyceae). *Phycological Research*, 46, 199–203.
- Kim, G. H., Lee, I. K., & Fritz, L. (1996). Cell-cell recognition during fertilization in a red alga, *Antithamnion sparsum* (Ceramiaceae, Rhodophyta). *Plant & Cell Physiology*, 37, 621–628.
- Mine, I., & Tatewaki, M. (1994). Attachment and fusion of gametes during fertilization of *Palmaria* SP. (Rhodophyta). *Journal of Phycology*, 30, 55–66.
- Miyamura, S. (2004). Visualization of the rapid fertilization process of the marine green alga, *Ulva arasakii* Chihara (Ulvophyceae, Chlorophyta) using high-speed video microscopy. *Cytologia*, 69, 97–201.
- Provasoli, L. (1968). Media and prospects for the cultivation of marine algae. In A. Watanabe & A. Hattori (Eds.), *Culture and collections of algae* (pp. 63–75). Hakone: Japanese Society of Plant Physiologist.
- Smith, G. M. (1947). On the reproduction of some Pacific coast species of *Ulva*. *American Journal of Botany*, 34, 80–87.

---

<sup>1</sup>Spores immediately attach to the substratum after replacing the seawater. Using seawater that contains the mother thalli prevents spores from adhering and allows for a unialgal culture with washing. Wash filtrated seawater containing the substratum from the mother thalli several times.



- 
- van den Hoek, C., Mann, D. G., & Jahns, H. M. (1995). Algae. In *An introduction to phycology*. Cambridge: Cambridge University Press.
- van der Meer, J. P., & Todd, E. R. (1980). The life history of *Palmaria palmata* in culture. A new type for the Rhodophyta. *Canadian Journal of Botany*, 58, 1250–1256.
- Wilson, S. M., Pickett-Heaps, J. D., & West, J. A. (2002). Fertilization and the cytoskeleton in the red alga *Bostrychia moritziana* (Rhodomelaceae, Rhodophyta). *European Journal of Phycology*, 37, 509–522.



Hiroaki Nakano

## Abstract

Many marine animals possess free-swimming larvae, with the larval morphology, behavior, and ecology showing a wide diversity within the metazoans. In this chapter, the merits and drawbacks of having a larval stage are discussed. Furthermore, current knowledge on the origins and evolution of marine larvae within the metazoans is described. Theories concerning the origins of the dipleurula-type larvae of deuterostomes and trochophore larvae of protostomes are explained in detail: whether they are homologous larval stages, or if they were acquired independently with their similarities being the result of convergence. The evolution of larval types within the echinoderms is also discussed. Moreover, the importance of these larvae in taxonomy is explained.

## 13.1 Overview

A larva is a life stage that comes between the embryo stage (cleavage, blastula, and gastrula) and metamorphosis into the adult stage. Many authors have proposed that larvae should have a radically different body plan from embryos and adults, and not just be miniaturized adults. Others have suggested that larvae should occupy a different ecological niche from adults, with the most common example being species with a pelagic (swimming) larval stage and benthic (bottom dwelling) adult stage.

Of the approximately 32 phyla, only one (Onychophora; velvet worms) lacks any marine representatives, and roughly 23 of the remaining 31 phyla have pelagic larvae that differ from the adults. Why is a larval stage so widely seen within the

---

H. Nakano (✉)

Shimoda Marine Research Center, University of Tsukuba, Shimoda, Shizuoka, Japan  
e-mail: [h.nakano@shimoda.tsukuba.ac.jp](mailto:h.nakano@shimoda.tsukuba.ac.jp)

Metazoa? Several advantages have been suggested for possessing larvae, with almost all based on the dispersal abilities of marine pelagic larvae. Pelagic larval stages enable a species to travel to and colonize new habitats. This increases their ability to withstand local extinction, in the event that a catastrophic change in environment occurs in the original habitat. Larval dispersal also decreases competition for resources and space between siblings and adults. Furthermore, the likelihood of inbreeding in the next generation can be expected to decrease significantly in species with swimming larval stages. Less predation by benthic predators is also likely. However, despite these merits, instances in which the larval stage has been secondarily lost can be found in diverse animal phyla across the Metazoa. For example, it is widely accepted that the immediate common ancestor of the phyla echinoderms and hemichordates possessed a feeding larva called the dipleurula (Hyman 1955). However, many species of these phyla are known to have only a shortened larval stage or have completely lost the larval stage. Some dispersal can still be expected from a shortened larval stage, but some species of sea stars within the echinoderms brood their offspring inside their bodies, with benthic juveniles being released from the adult body, completely abolishing the larval dispersal stage. This has happened independently and many times within these phyla. If a larva is so advantageous (as discussed above), why did some species discard the pelagic larval stage during evolution? Some disadvantages for pelagic larva have been suggested: the habitat of the adults is favorable enough to enable reproduction, and a pelagic larva will be carried away from that habitat; their destination might not be suitable for settlement, resulting in the death of the larvae; small and normally fragile larval bodies are more susceptible to environmental change and pelagic predation; and there are various costs in making a developmental stage with a completely different body plan from that of the adult stage. It has not been proven if the advantages of having a larval stage outweigh the disadvantages, or vice versa. It is most likely that it will depend on various factors, such as the abiotic environment (e.g., water temperature, currents, and organic compounds in the sea), predation, and prey availability. The quantitative and qualitative merits and demerits of possessing a larval stage probably differ from species to species, and can depend on the time and location even within the same species.

---

## 13.2 Diversity of Animal Larvae

A rich diversity of metazoan larvae can be collected using a plankton net. Table 13.1 summarizes the larvae that can be collected from the Japanese seas, focusing on those that may be collected during marine courses. There are instances where a single larval type is found from multiple animal phyla, such as the trochophore larva being found from molluscs, annelids, and entoprocts. But many phyla or classes possess specific larval types, so it is possible to identify the phylum or class the larva belongs to from external observations.

**Table 13.1** Larvae of various animal groups

Group	Larval type
Porifera	Parenchymella, amphiblastula
Ctenophora	Cydippid
Cnidaria	Planula
Xenacoelomorpha	Planula-like free-swimming stage
Platyhelminthes	Muller's, Kato's, Gotte's
Annelida	Trochophore, nectochaeta
Molluscs	Trochophore, veliger, D-shaped larva
Entoprocta	Trochophore
Bryozoa	Cyphonautes
Nemertea	Pilidium
Phoronida	Actinotrocha
Brachiopoda	Free-swimming larva
Arthropoda	Nauplius, zoea, megalopa, phyllosoma, mysis
Echinodermata	Bipinnaria, brachiolaria, ophiopluteus, vitellaria, echinopluteus, auricularia, doliolaria
Hemichordata	Tornaria
Tunicata	Tadpole-like larva
Vertebrata	Leptocephalus

The list does not cover all larval types, but is focused on larvae that are frequently collected during marine course at Japanese marine stations

### 13.3 Evolution of Larvae Within Metazoa

Various pelagic feeding larvae have been reported from hemichordates and echinoderms within the deuterostomes. These include the tornaria of hemichordates, echinopluteus of sea urchins and sand dollars, ophiopluteus of brittle stars, auricularia of sea cucumbers, and bipinnaria of sea stars. All of these larvae have a common bilateral body plan: a digestive tube with a midventral mouth and an anus, bilaterally situated tripartite coeloms, and a ciliated band encircling the mouth. Based on this similarity, these larvae are collectively called the dipleurula-type larva, and this type of larva was suggested to have been present in the last common ancestor of the Ambulacraria (hemichordates and echinoderms) (Hyman 1955). Moreover, it was also proposed that a dipleurula-type larva was already present in the last common ancestor of deuterostomes, including chordates. Some hypotheses have even suggested that the chordate body plan with a centralized nervous system with a brain and nerve cord originated from the dipleurula-type larva body plan (Garstang 1894).

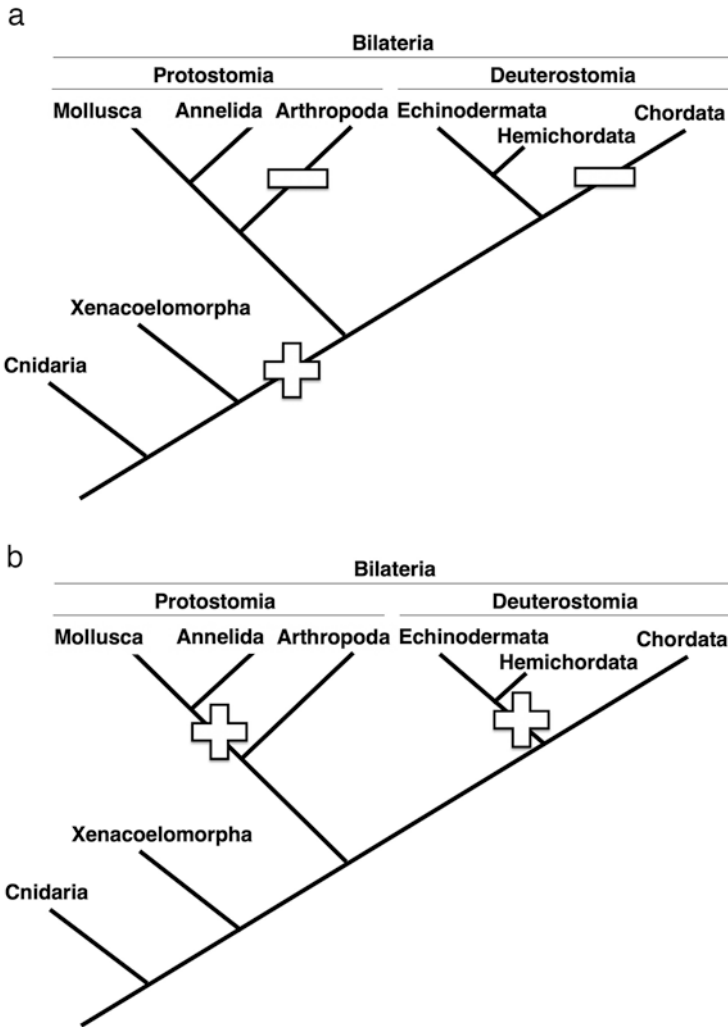
Looking at protostomes, marine pelagic feeding larvae with a common body plan (a digestive tube with a midventral mouth and an anus, and a ciliated band encircling the mouth) can be seen in annelids, molluscs, and entoprocts, and have been named the trochophore larva. A typical trochophore larva is found only from these phyla, but similar larvae have been reported from larvae of other protostome phyla. For instance, Muller's larva in the Platyhelminthes lacks an anus and possesses long lobes, but besides these traits, they are essentially a trochophore larva.

Another larva similar to a trochophore is the nemertean pilidium larva. Since the trochophore and similar larva have been reported from many protostome phyla, it was suggested that the larval stage was present in the last common ancestor of protostomes.

Since the dipleurula-type larva and trochophore larva were suggested to have been present in the last common ancestor of deuterostomes and protostomes, respectively, and since the two types of larvae share some traits, it was proposed that these two larvae are homologous (Fig. 13.1a). In other words, a feeding bilateral larva with characteristics common between the two types of larvae (a digestive tube with a midventral mouth and an anus, apical tuft and organ, and a ciliated band encircling the mouth) was already present in the last common ancestor of bilaterians (Nielsen 2012). Reports of common genes expressions in the same regions (e.g., apical organ, foregut, parts of the ciliary band) in these larvae gave further support for this view (e.g., Arendt et al. 2001).

However, there are reports that oppose this hypothesis. The directions of the beating in the cilia surrounding the mouth is 180° opposite in the two larvae, with the cilia beating towards the mouth in trochophores, and away from the mouth in dipleurula-type larvae. Although common gene expressions are reported for some organs or parts of some organs, the shared expression of genes that pattern the whole larval body plan have not been reported. The strongest counter evidence for the above hypothesis comes from phylogenetics: recent phylogenomic analyses have shown that the protostomes can be divided into two large groups, the spiralian and ecdysozoans (Halanych et al. 1995). All phyla with a trochophore or similar type of larva were grouped into the Spiralia, with no trochophore larva being reported from the Ecdysozoa. Looking at deuterostomes, recent phylogenomic studies support the sister group relationship of echinoderms and hemichordates (Ambulacraria) with chordates, from which no dipleurula-type larvae have been reported. Therefore, it is currently most parsimonious to assume that the trochophore was acquired in the last common ancestor of spiralian after the ecdysozoans had branched, and therefore were not present in the last common ancestor of protostomes. Similarly, it is probable that the dipleurula-type larvae were acquired in the last common ancestor of Ambulacraria after the chordates had branched, and were therefore not present in the last common ancestor of deuterostomes. According to this view, the similarities seen between the two types of larvae are due to convergence. Moreover, it becomes more unlikely that a feeding bilateral larva with characteristics common between the two types of larvae was already present in the last common ancestor of bilaterians (Fig. 13.1b).

One way to solve the homology/convergence problem of the trochophore and dipleurula is to look at outgroups. If any animal group not included within Bilateria possess a similar type of larvae, it becomes more likely that the two types of larva are homologous. Currently, there are four metazoan phyla widely accepted to be excluded from the Bilaterians: Ctenophora, Porifera (sponges), Placozoa, and Cnidaria. Although swimming larvae are present in three of the phyla (placozoans were first reported more than 120 years ago, but their complete development remains unknown), bilateral feeding larvae similar to the trochophore and dipleurula have



**Fig. 13.1** Two hypotheses on the origins of feeding planktonic larvae (trochophore larva and dipleurula-type larva) in the bilateria. **(a)** A feeding planktonic larva was acquired in the last common ancestor of protostomes and deuterostomes, and independently lost in arthropods and chordates. In this hypothesis, the trochophore larva and dipleurula-type larva can be regarded as homologous. **(b)** The trochophore larva was acquired in the last common ancestor of molluscs and annelids, while the dipleurula-type larva was acquired in the last common ancestor of echinoderms and hemichordates. Plus: gain of feeding larva; minus: loss of feeding larva

not been reported. Another phylum of interest concerning this problem is the Xenacoelomorpha. This clade consists of acoels, nematodermatids, and xenoturbellids, all marine worms with simple body plans lacking anuses or coeloms. The phylogenetic position of this clade has not been decided between two main hypotheses: whether it is a member of the deuterostomes (Philippe et al. 2011), or a sister

group to the traditional Bilateria (protostomes + deuterostomes, now called the Nephrozoa) (Cannon et al. 2016). Although swimming stage embryos/larvae are known from some species within the phylum (Henley 1974; Nakano et al. 2013), no bilateral feeding larvae have been reported.

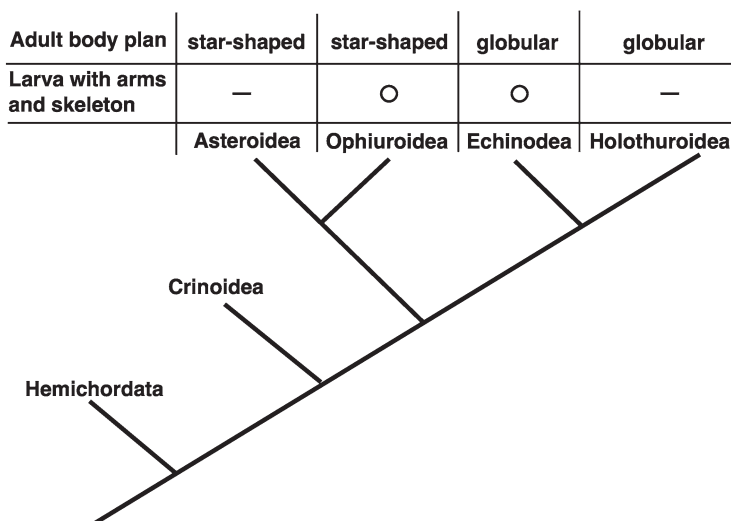
To summarize, since no trochophores and dipleurulas have been found outside Spiralia and Ambulacraria, respectively, it is currently most parsimonious to regard the two types of larva as due to convergence. The common gene expression reported for the parts of some organs can be regarded as homology of only the organs and not the whole larva (e.g., the apical organ can be found in both xenacoelomorph and cnidarian larvae) (Nakano et al. 2013). Otherwise, they may be instances of the co-option of certain developmental genes. More developmental, morphological, and gene expression and function studies on larvae of a wide variety of extant metazoans, as well as paleontological research on fossilized embryos, will elucidate the origin and evolution of marine pelagic larvae.

---

### 13.4 Evolution of Larvae Within Echinoderms

The echinoderm adult body plan is unique within the Metazoa in that it shows pentaradial symmetry. However, many species in the phylum have dipleurula-type larvae. The larvae are all bilateral, and the adult body plan is generated through radical metamorphosis. The dipleurula-type larvae of the extant four classes of Eleutherozoa can be divided into two groups. Echinoids and ophiuroids have nearly identical larvae (echinopluteus/ophiopluteus) with skeletally supported arms. Asteroids and holothurians possess very similar larvae (bipinnaria/auricularia) that do not have arms with skeletal rods. However, the morphological similarities in the larvae of the four classes are contradictory to the phylogeny of the echinoderm classes widely accepted today. Echinoids and holothurians are regarded to form a monophyletic group, whereas asteroids and ophiuroids are regarded as sister groups (Fig. 13.2). This theory is supported by adult morphology and recent phylogenomic analyses (Reich et al. 2015).

How did the dipleurula-type larvae evolve within echinoderms? The only extant class not included within the Eleutherozoa (the above four classes of echinoderms) are the crinoids, consisting of feather stars and sea lilies. Although most species of this class lack dipleurula-type larvae, one species of sea lily, *Metacrinus rotundus*, has been shown to possess bipinnaria/auricularia type larvae, lacking arms with skeletal rods (Nakano et al. 2003). Furthermore, the hemichordates, accepted as the sister group to the echinoderms, possess dipleurula-type larvae (tornarias) that do not have arms with skeletal rods. This indicates that the last common ancestor of echinoderms and hemichordates, and also that of echinoderms, had dipleurula-type larvae without arms with skeletal rods. Furthermore, it is parsimonious to regard that a dipleurula-type larva without arms is ancestral for Eleutherozoa, and that the nearly identical pluteus larva seen in echinoids and ophiuroids are due to convergence. Recent evolutionary developmental biology studies have suggested that the skeletal rods in echinoid and ophiuroid pluteus larvae may have been acquired by



**Fig. 13.2** Differences in adult and larval morphology within the four classes of echinoderms

the independent co-option of genes used for adult skeleton formation, resulting in similar morphologies (Morino et al. 2016).

This example in echinoderms is very interesting, in that it clearly shows that larval morphology can evolve independently from adult morphology, resulting in discrepancies between the morphologies. Furthermore, it also shows that larval and adult morphologies can be linked through the co-option of developmental genes. Further functional and expression studies on genetic toolkits used in larval body formation, together with morphological and developmental research, can elucidate the evolution of larvae in echinoderms, as well as those in other metazoan groups.

### 13.5 Larvae as Taxonomically Important Characteristics

Traditionally, various characteristics have been suggested as phylogenetically significant. Embryological origins of the mouth and anus, or in other words, the fate of the blastopore, has been regarded as of utmost importance, and was used for naming the two major groups within the bilaterians: the protostomes, in which the blastopore becomes the mouth, and the deuterostomes, in which the blastopore becomes the anus. However, some exceptions have been reported: some annelids (which are protostomes) show deuterostomy, and some annelid and nematode species form both the mouth and anus from the blastopore (Martín-Durán et al. 2016). Another trait traditionally regarded as phylogenetically important is the cleavage pattern. Protostomes and deuterostomes are known to possess spiral and radial cleavage, respectively. But numerous protostome groups, such as chaetognaths (arrow worms), rotifers, gastrotrichs, and brachiopods, show radial cleavage. Coelom



formation is also described in textbooks to be phylogenetically relevant, with protozoans showing schizocoely and deuterostomes showing enterocoely. However, schizocoely has been reported in hemichordates, echinoderms, and chordates, all deuterostomes, whereas enterocoely has been reported in several protostome groups. It is not that these characteristics are not phylogenetically significant, but it should be pointed out that exceptions are present for the above characteristics.

Larvae have also been regarded as phylogenetically significant, and unlike the other traits discussed above, exceptions are scarce. All species with dipleurula-type larvae are members of the Ambulacraria (hemichordates and echinoderms), whereas trochophore larvae are only found within the Lophotrochozoans. Many larval types, such as the cirripeds, nauplii, or plutei, are specific to a certain phylum. Since adult morphology can evolve independently of larval morphology as discussed above, larval morphology has been used to show the phylogenetic positions of species whose adults possess highly derived morphologies.

Tunicates were long regarded as a member of the Mollusca. In 1866, the Russian zoologist Alexander Kovalevsky reported that tunicates possess tadpole-like larvae, with a dorsal nerve cord, notochord, and tail muscle (Kovalevsky 1866). These traits are all found in vertebrates, and strongly suggest that tunicates are closely related to vertebrates. This affinity is now supported by evolutionary developmental biology studies and phylogenomic analyses.

Barnacles were also once regarded as molluscs based on their sessile life style and hard shells resembling those of limpets. However, zoologists John Vaughan Thompson in 1830 and Hermann Burmeister in 1834 reported that they possess nauplius and cypris larvae (Thompson 1830; Burmeister 1834), showing that they are crustaceans within the phylum Arthropoda, a phylogenetic position that is widely accepted today.

With the rise of molecular phylogenetic analysis, larval morphology has not played a definitive role in determining the phylogenetic position of newly discovered animals recently. However, they have added support for results obtained from the molecular phylogenetic analyses of animals with highly derived adult morphologies. The giant tube worm *Riftia pachyptila* is a marine worm first reported in 1981 near deep-sea hydrothermal vents (Jones 1981). Bone-eating worms of the genus *Osedax* were first discovered in 2002 growing from whale bones decaying on the sea bottom (Rouse et al. 2004). Both worms lack a digestive system, due to their symbiotic bacteria. Molecular phylogeny suggests that both animals are members of the phylum Annelida, and their larval morphology, with both worms possessing trochophore-like larvae, gives additional support to this view (Marsh et al. 2001; Rouse et al. 2009).

---

## References

- Arendt, D., Technau, U., & Wittbrodt, J. (2001). Evolution of the bilaterian larval foregut. *Nature*, 409, 81–85.
- Burmeister, H. (1834). *Beiträge zur Naturgeschichte der Rankenfüßser (Cirripedia)*. Berlin: G. Reimer.

- Cannon, J. T., Vellutini, B. C., Smith III, J., et al. (2016). Xenacoelomorpha is the sister group to Nephrozoa. *Nature*, *530*, 89–93.
- Garstang, W. (1894). Preliminary note on a new theory of the phylogeny of the Chordata. *Zoologischer Anzeiger*, *17*, 122–125.
- Halanych, K. M., Bacheller, J. D., Aguinaldo, A. M. A., et al. (1995). Evidence from 18S ribosomal DNA that the lophophorates are protostome animals. *Science*, *267*, 1641–1643.
- Henley, C. (1974). Platyhelminthes (Turbellaria). In A. C. Giese & J. S. Pearse (Eds.), *Reproduction of marine invertebrates: Vol. 1 Acoelomate and Pseudocoelomate metazoans* (pp. 267–343). New York: Academic Press.
- Hyman, L. H. (1955). *The invertebrates. Echinodermata: The coelomate bilateria* (Vol. 4). New York: McGraw-Hill.
- Jones, M. L. (1981). *Riftia pachyptila*, new genus, new species, the vestimentiferan worm from the Galápagos rift geothermal vents (Pogonophora). *Proceedings of Biological Society of Washington*, *93*(4), 1295–1313.
- Kowalevsky, A. (1866). Entwicklungsgeschichte der einfachen Ascidien. *Mémoires de l'Académie Mémoires de l'Académie série*, *7*(10), 1–19.
- Marsh, A. G., Mullineaux, L. S., Young, C. M., & Manahan, D. T. (2001). Larval dispersal potential of the tubeworm *Riftia pachyptila* at deep-sea hydrothermal vents. *Nature*, *411*, 77–80.
- Martín-Durán, J. M., Passamanek, Y. J., Martindale, M. Q., & Hejnal, A. (2016). The developmental basis for the recurrent evolution of deuterostomy and protostomy. *Nature Ecology and Evolution*, *1*, 0005.
- Morino, Y., Koga, H., & Wada, H. (2016). The conserved genetic background for pluteus arm development in brittle stars and sea urchin. *Evolution and Development*, *18*, 89–95.
- Nakano, H., Hibino, T., Oji, T., et al. (2003). Larval stages of a living sea lily (stalked crinoid echinoderm). *Nature*, *421*, 158–160.
- Nakano, H., Lundin, K., Bourlat, S. J., et al. (2013). *Xenoturbella bocki* exhibits direct development with similarities to Acoelomorpha. *Nature Communications*, *4*, 1537. <https://doi.org/10.1038/ncomms2556>
- Nielsen, C. (2012). *Animal evolution: Interrelationships of the living phyla* (3rd ed.). Oxford: Oxford University Press.
- Philippe, H., Brinkmann, H., Copley, R. R., et al. (2011). Acoelomorph flatworms are deuterostomes related to *Xenoturbella*. *Nature*, *470*, 255–258.
- Reich, A., Dunn, C., Akasaka, K., et al. (2015). Phylogenomic analyses of Echinodermata support the sister groups of Asterozoa and Echinozoa. *PLoS One*, *10*, e0119627.
- Rouse, G. W., Goffredi, S. K., & Vrijenhoek, R. C. (2004). *Osedax*: Bone-eating marine worms with dwarf males. *Science*, *305*, 668–671.
- Rouse, G. W., Wilson, N. G., Goffredi, S. K., et al. (2009). Spawning and development in *Osedax* boneworms (Siboglinidae, Annelida). *Marine Biology*, *156*, 395–405.
- Thompson, J. V. (1830). Memoir IV. On the cirripedes, or barnacles; demonstrating their deceptive character; the extraordinary metamorphosis they undergo, and the class of animals to which they indisputably belong. *Zoological Research*, *3*, 69–82.

---

**Part III**

**Marine Zoology**



# Contribution of Marine Animals in Physiology, Endocrinology, and Ethology

# 14

Kazuo Inaba

## Abstract

As in the field of cell biology and developmental biology, many important findings have been made in a range of biological fields using marine organisms. All of these studies provide us with opportunities to understand the diversity of marine organisms in terms of their body plan including the functions of specific cells, tissues, and organs. This diversity has provided a number of key tools and experimental approaches for researchers to determine some of the general underlying mechanisms for life. Here I introduce some examples of significant findings in zoology, in particular those in physiology, endocrinology and ethology.

Beside the research introduced in Chap. 8, many other pioneer findings in basic biology have been achieved using marine organisms. These include the experiment by Henry Van Wilson (1907), who established the method for dissociation and reaggregation of cells from two different sponges and gave important insights into the nature of recognition, differentiation and regeneration of a cell. A series of studies by Hidemiti Oka and Hiroshi Watanabe, which were done at the Shimoda Marine Research Center using colonial ascidians, provided important insights into the histocompatibility reaction and its genetic background, and a greater understanding of immune system evolution. Jellyfish have several bioluminescent and fluorescent materials, which are thought to have a role in their communication. One of these materials, a green fluorescent protein (GFP) was isolated from the jellyfish *Aequorea coerulescens* by Osamu Shimomura. The finding of GFP led to the development of an important genetic tool for labeling a protein as a GFP-fusion protein, allowing for key advances in the life sciences. Like GFP, several

---

K. Inaba (✉)

Shimoda Marine Research Center, University of Tsukuba, Shimoda, Shizuoka, Japan  
e-mail: [kinaba@shimoda.tsukuba.ac.jp](mailto:kinaba@shimoda.tsukuba.ac.jp)

molecules, large or small, have been identified in marine organisms and are used as powerful experimental tools and approaches. Although small natural products from marine organisms (such as drugs for channels or enzymes) are not the subject of this book, it is important to note that these compounds play key roles in chemical communication among the organisms.

Physiology originally started as an academic field focusing on the experiments or measurements of body activity mostly in humans and vertebrates, such as muscle contraction and nerve transmission. Since then, it has spread to the field of general physiology including those on marine organisms and has now expanded into several new academic fields, including cell physiology and plant physiology. The contribution of marine organisms in the progression of physiological research is particularly remarkable. A variety of body plans found in marine organisms provide simple and desirable experimental systems for investigating physiology. For example, cephalopods have a giant axon (0.5 mm in diameter), for which John Zachary Young highlighted the advantages in their use in the field of neurophysiology. Using a long-finned squid *Loligo forbesii*, Alan Hodgkin and Andrew Huxley (1945) directly recorded the ionic currents across the plasma membrane using a voltage clamp. Their study and theory provided a great influence on understanding how voltage-gated ion channels generate and propagate action potential. Regarding the experimental advantages of using squids, several decades later, one of the major protein



**Fig. 14.1** Alan Hodgkin and Andrew Huxley, in front of the experimental apparatus measuring ionic current of nerve fibers. From the cover of the 1963 Nobel Prize Program. Reproduced from Schwiening (2012) with permission

motors, kinesin, was first isolated from the cytoplasm of giant axon (Vale et al. 1985). The studies of Hodgkin and Huxley were carried out in several marine stations, mostly in the Marine Biological Association (MBA), Plymouth, UK, which was founded in 1884 (Fig. 14.1). The first director of the MBA was Thomas Henry Huxley, who was a strong supporter of Darwinism and emphasized the importance of general physiology. Both Young and Hodgkin, as well as two other prominent physiologists, Archibald Vivian Hill (muscle contraction) and James Gray (ciliary movement), also served as the directors of the MBA. Another example of pioneer research in the field of neurobiology are the works by Eric Kandel from middle to late 1900s which aimed to understand the molecular mechanisms of higher-order activity in neurons. He used the sea slug *Aplysia californica*, of which central nerve system is composed of only approximately 10,000 large neurons with nine ganglia, and identified the molecules and signaling involved in neuroplasticity and learning. His works is one of the key breakthroughs in general neurobiology. Research in general physiology in Japan began in the 1920s in Tohoku University (Shinkichi Hatai) and the University of Tokyo (Takeo Kamata, Haruo Kinoshita). Since then, several eminent pieces of research were done on marine organisms, earlier topics including ciliary motility of mussel and sea squirt gills, membrane potentials of sea urchin eggs, molluscan catch muscle, and photo-response of Diadematidae (sea urchin) and jellyfish.

Endocrinology is the study of integrated physiological changes and behavior regulated by endocrine systems. The major subjects of endocrinology are the identification and synthetic pathway of hormones (steroids and peptides), their secretory pathway (endocrine glands, neurons, and circulating system), and their actions on the target organs. It started in vertebrates but later comparative endocrinology was born in late 1940s to understand the diversity and evolution of this regulatory system. Some pioneering scientists, such as Howard A. Bern and Aubrey Gorbman, greatly contributed to the development of this academic field. The endocrine system of marine animals plays a key role in environmental adaptation. The endocrinological system in marine animals covers a wide range of aspects including osmotic regulation, ionic adsorption and metabolism, body coloration, regulation of gonadal development and reproduction, and growth and metamorphosis. Administration of gonadotropin-releasing hormone (GnRH), also called as luteinizing hormone releasing hormone (LHRH), and follicle stimulating hormone releasing hormone (FSH-RH), or pituitary gonadotropin (GTH; *human* chorionic gonadotropin, HCG is often substituted for use) is practically employed in aquaculture of fish. Studies in comparative endocrinology have predominantly focused on fish and crustaceans but endocrinological research has also been performed on a range of other marine invertebrates. Among them, the first identification of starfish hormones, i.e., gonad stimulating substance (GSS) and maturation inducing substance (MIS, or MIH for maturation inducing hormone) for oocyte, studied by Haruo Kanatani and his collaborators (1969) is of particular note. Similar hormones in sea cucumbers have also brought advances in fisheries science (Fujiwara et al. 2010). One of the important reports regarding endocrinology in marine animals is

the endocrine disruption by some anthropogenic chemical compounds. They act as inhibitors or analogous competitors of hormones. Beginning with a seminal work by Howard A. Bern in 1960s, a number of studies have been reported on this issue in marine fish and invertebrates in the last three or four decades. Endocrine disruption is an example of how an anthropogenically derived chemical compound can negatively impact the marine ecosystem.

Animal behavior is an integral output of neurophysiological and endocrinological activities in response to several internal or environmental stimuli. The study of animal behavior, also called ethology, is thought to start from Fabre or Darwin, but it is likely that there must have been many observations of animal behavior in a scientific manner before that. Modern ethology was established and became recognized as an academic research field following works by Konrad Z. Lorenz (imprinting of graylag goose), Nikolaas Tinbergen (nest building of stickleback), and Karl von Frisch (honeybee dance) around mid-1900s. Since then, ethology has targeted several key behavioral patterns in animals: from daily behavior, feeding, avoidance from predators, territorial behavior, sociality, parasitism, and symbiosis to sexual behavior, nest-building behavior, brooding behavior, and migration. Marine organisms are exposed to numerous types of physical and chemical conditions, such as temperature, osmolality, salinity, pH, O<sub>2</sub>/CO<sub>2</sub> concentration, tides, light, currents, water pressure, hydrodynamic force, and magnetic field. They adapted to or utilized these environments as cues in order to exhibit a particular behavior. Morphologically and functionally unique traits acquired through evolution may generally act as selective advantages for the success in habitat selection and reproduction, which are often accompanied with unique behaviors, including fighting, courtship, and mating (Kawano and Henmi 2016; Backwell 2019). The resulting habitat selection, adaptation, and reproductive strategy are the basis for the formation of marine communities. To clarify the mechanism or critical factors for animal behavior, ethologists start from field observation and pattern analysis, and then perform experimental verification if necessary. However, in some cases where animals show long-distance locomotion or migration in the sea, it is difficult to trace and observe them. Downsizing of a tracer tag equipped with a camera, GPS, and several sensors, called biologger, made it possible to track the behavior of animals and their environments. Biologging is exploring many hidden behaviors of marine animals, for example, surprisingly high-speed swimming and accompanied thermoregulation by surfacing fish (Nakamura et al. 2015) and the diving behavior of marine mammals (Chap. 30).

From Chaps. 15 to 17, several practical approaches to the studies of physiology, endocrinology, and ethology are described. All of them have been included in the program of marine courses at Japanese marine stations. Distinct from biochemistry or molecular biology, these fields of study give you an opportunity to experience the 'live' activities of marine animals.

## References

- Backwell, P. R. Y. (2019). Synchronous waving in fiddler crabs: A review. *Current Zoology*, *65*, 83–88.
- Fujiwara, A., Yamano, K., Ohno, K., & Yoshikuni, M. (2010). Spawning induced by cubifrin in the Japanese common sea cucumber *Apostichopus japonicus*. *Fish Sci*, *76*, 795–801.
- Hodgkin, A. L., & Huxley, A. F. (1945). Resting and action potentials in single nerve fibres. *The Journal of Physiology*, *104*(2), 176–195.
- Kanatani, H., Shirai, H., Nakanishi, K., & Kurokawa, T. (1969). Isolation and identification of meiosis inducing substance in starfish *Asterias amurensis*. *Nature*, *221*, 273–274.
- Kawano, Y., & Henmi, Y. (2016). Female preference for large waving claws in the dotillid crab *Ilyoplax pusilla*. *Journal of Ethology*, *34*(3), 255–261.
- Nakamura, I., Goto, Y., & Sato, K. (2015). Ocean sunfish rewarm at the surface after deep excursions to forage for siphonophores. *Journal of Animal Ecology*, *84*, 590–603.
- Schwiening, C. J. (2012). A brief historical perspective: Hodgkin and Huxley. *The Journal of Physiology*, *590*, 2571–2575.
- Vale, R. D., Reese, T. S., & Sheetz, M. P. (1985). Identification of a novel force-generating protein, kinesin, involved in microtubule-based motility. *Cell*, *42*, 39–50.
- Wilson, H. V. (1907). On some phenomena of coalescence and regeneration in sponges. *Journal of Experimental Zoology*, *5*, 245–258.





Chikako Shingyoji and Kenjiro Yoshimura

## Abstract

Marine animals have contributed significantly to the development of the studies of general and comparative physiology. Experiments on nerve excitation in squids, muscle contraction in bivalves, and heart function in octopus and tunicates are introduced in this chapter. Squids have a *giant axon*, which enables effective ejection of water from the mantle upon jet propulsion. The giant axon can be isolated to measure the conduction velocity of action potential. Bivalves have *catch muscle*, which exerts force almost without energy expenditure while attached to rocks. Catch muscle can be prepared with or without nerve to induce contraction by applying electrical stimuli or neurotransmitter. Hearts in octopus and tunicates modulate output by controlling the heart rate and the blood flow direction, respectively. Hydrostatic pressure can be applied to isolated octopus heart and examine how the heart rate is affected by the blood pressure. It is also possible to induce and observe reversals of the blood flow in tunicate tubular hearts.

---

C. Shingyoji (✉)

Department of Biological Sciences, Graduate School of Science, The University of Tokyo, Tokyo, Japan

e-mail: [chikako@bs.s.u-tokyo.ac.jp](mailto:chikako@bs.s.u-tokyo.ac.jp)

K. Yoshimura

Department of Machinery and Control Systems, College of Systems Engineering and Science, Shibaura Institute of Technology, Tokyo, Japan

## 15.1 Overview

Studies of marine creatures have provided knowledge about many principles of physiology. Among those, the squid, a member of Cephalopoda, is particularly historically important. It gave us a chance to understand the basic mechanism of nerve conduction as well as the jet propulsion system of cephalopods. Cephalopods have a ‘giant axon’, a nerve fiber of great diameter and length, which conducts impulses faster than a thinner fiber and enables the mantle to contract in a coordinated manner. The giant axon is an ideal material for measuring the changes in membrane potential during excitation because of its size and length.

In physiological research, researchers have been challenged to answer the mechanism of function (e.g., of the giant axon) by analyzing the responses to an applied stimulus. Such analytical experiments usually need the development of methods and equipment suitable for specific use. Therefore, physiology is unique among various fields of biology because the methods for even a basic experiment are different from researcher to researcher (or from laboratory to laboratory).

In this subchapter, we selected three themes on four kinds of animals: Sect. 15.2. Giant Axon of the Squid, Sect. 15.3. Anterior Byssus Retractor Muscle of *Mytilus*, and Sect. 15.4. Octopus Hearts and Tunicate Hearts. Detailed backgrounds of these themes are shown at the beginning of each section. These studies were originally been carried out as part of seven themes of the regular program of a laboratory class in marine biology included in the Zoology Course curriculum at the University of Tokyo (1974–1995). We, the authors of this subchapter (CS and KY) contributed to the laboratory class at Misaki Marine Biological Station every summer as assistant professors under the supervision of Professor Keiichi Takahashi. We chose the themes for this book based on the belief that they are essential for learning the basic aspects of animal marine physiology.

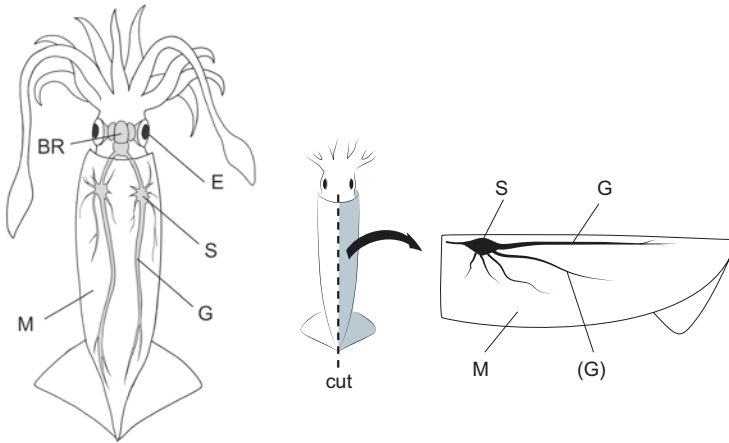
---

## 15.2 Giant Axon of the Squid

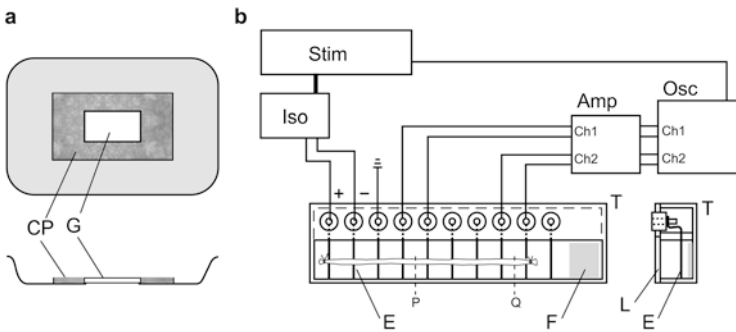
### Background

The squid giant nerve fiber, or giant axon, is important because of its contribution to our understanding of neurophysiology. Squids use jet propulsion to escape attacks by predators. This jet propulsion is brought about by the simultaneous muscular contraction of the whole mantle. Since the ganglion controlling the mantle muscles is located close to the ejection site, the nerve fibers innervated to the distal part of the mantle should conduct the impulse faster than those connected to the proximal part so that impulses arrive simultaneously at each part (Fig. 15.1). The giant axon enables the faster conduction of these impulses.

Basic characteristics found in the squid giant axon are shared with those in the nerve fibers of other animals. In other words, although cephalopods including squids appear quite distinct from vertebrates, they have a lot of neuronal functions that we normally associate only with vertebrates. The great diameter and length of



**Fig. 15.1** Squid and its giant axon. Left: Dorsal image showing the position of brain (BR) between the eyes (E) and the route of the giant axons (G) on the left and right of the mantle (M), which are each projected from the stellate ganglion (S). Middle: Ventral side image. Right: Dissected piece of mantle with the stellate ganglion and giant axons



**Fig. 15.2** Experimental setup. (a) A vat used for the preparation of the giant axon. A glass window (G) is surrounded by a cork plate (CP). (b) Diagram showing the stimulator (Stim), isolator (Iso), amplifier for extracellular recording (Amp), oscilloscope (Osc), trough (T), electrode (E), filter paper (F), and lid (L). The top and side views of the trough are shown

the squid giant axon is fascinating for neural research and suitable for laboratory study at a sophisticated level; the study of nerve pulses in the giant axon of the squid even won the Nobel Prize in Physiology or Medicine in 1963.

In this section, we will first observe these historic nerve fibers in the mantle of live squid. Next, we will dissect one of the several giant fibers from their mantle. Using electric stimulation, we will trigger and record an action potential extracellularly. Data on the conduction velocity are plotted against the fiber diameter to enable a discussion on the relationship between the two.

## Material and Methods

Material	<i>Ommastrephes bartramii</i> (neon flying squid) <i>Sepioteuthis lessoniana</i> (bigfin reef squid), or <i>Loligo edulis</i> (swordtip squid)
Solution	Cold seawater (filtered natural seawater or ASW)
Instruments	Differential amplifier for extracellular recording (e.g., MEG-5200 by Nihon Kohden) Digital storage oscilloscope Stimulator (e.g., SEN-3401 and SS-203 J by Nihon Kohden)
Items	Vat (a vat with glass window and cork on the bottom, Fig. 15.2a) Chamber (acrylic moist chamber with a lid. Seven [or more] Ag–AgCl electrodes are placed at intervals of 5–10 mm, Fig. 15.2b) Cork borer, thread, filter paper, needle Faraday cage (a metal case and plate that can cover the measuring chamber) Ice, warm water Binocular microscope, micrometer

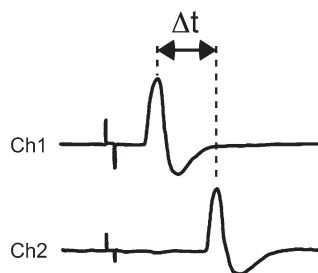
## Procedures

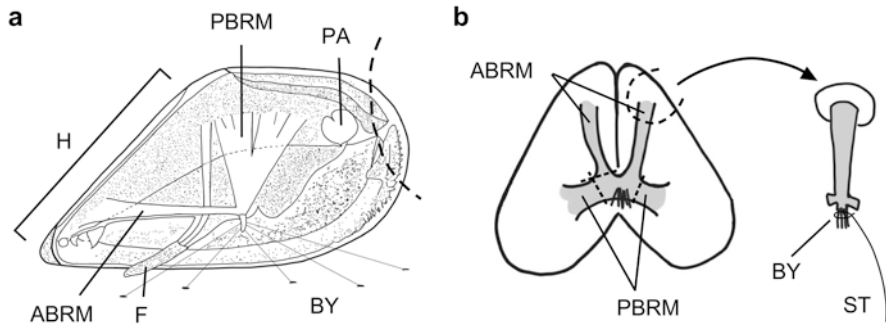
### 1. Isolation of giant axon.

- (a) Destroy the brain by punching out the head between the two eyes with a cork borer (approximately 1 cm in diameter).
- (b) Open the ventral side (the side on which the funnel emerges) of the mantle by cutting it along the median line (Fig. 15.1, middle). Remove the viscera. Observe the nerve fibers in the mantle and carefully survey the route of the giant nerve fibers extending from the stellate ganglion (Fig. 15.1, right).
- (c) (optional) Cut the mantle along the dorsal median line. You will get two halves of the mantle and two people can prepare the giant axon from each half simultaneously. Avoid handling directly with warm hands.
- (d) The below procedure should be carried out in cold seawater as quickly as possible. Pour cold seawater in a vat and place a plastic bag containing ice inside to keep the seawater cold. Immerse the mantle in the seawater.
- (e) Identify a giant axon that is thicker and longer than the others emerging from the stellate ganglion. Fix the mantle by sticking the mantle on the cork by needles (Fig. 15.2a).
- (f) Cut open the muscle covering the stellate ganglion and tie the giant axon close to the stellate ganglion with a thread. Cut off the giant axon from the stellate ganglion.
- (g) Isolate the giant axon by cutting open the muscle covering the giant axon while lifting the thread attached to the end of the giant axon. Isolate it for as long as possible. Do not leave muscle attached to the giant axon since the electrical signal from muscle will overlap with the signal from the giant axon.

- (h) (optional) Stimulate the giant axon electrically while isolated and observe the contraction of mantle.
  - (i) When the giant axon of sufficient length is isolated, tie the distal end with a thread and detach the giant axon from the mantle. The steps for dissection should be finished as soon as possible.
  - (j) If preparation of the first giant axon is completed within a short period, try to dissect the second or third sizes of axons. This is a useful step for the discussion of the effect of the fiber diameter on the conduction velocity.
2. Extracellular recording of action potential.
- (a) Measure the distance between electrodes.
  - (b) Connect the chamber to a stimulator and amplifier as shown in Fig. 15.2b.
  - (c) Set the giant axon in a trough. Add filter paper moistened with seawater to keep the chamber moist.
  - (d) Stimulate the giant axon at various intensities. The duration should be 1 ms (or less). Observe the amplitude and shape of the action potential simultaneously at the two positions (Fig. 15.3).
  - (e) If the giant axon is long enough, change the position of measurement.
  - (f) Measure the diameter of the giant axon at the position of P and Q in Fig. 15.2 with a binocular microscope.
  - (g) Measure the temperature in the chamber.
  - (h) (Optional) Change the temperature in the chamber by placing the chamber on a plastic bag containing water of different temperatures. Measure the conduction velocity at different temperatures.
3. Analysis of conduction velocity.
- (a) Calculate the conduction velocity based on the time shift of the peaks of action potential (Fig. 15.3) and the distance between the electrodes.
  - (b) Collect the data of conduction velocity and the diameter of the axon from different preparations. Use the mean diameter between points P and Q. Plot the conduction velocity against the diameter.

**Fig. 15.3** Schematic presentation of action potential recorded at two positions. The lag of the peak is shown by  $\Delta t$





**Fig. 15.4** *Mytilus galloprovincialis* ABRM. (a) Diagram showing the foot (F), byssus (BY), anterior byssus retractor muscle (ABRM), posterior byssus retractor muscle (PBRM), posterior adductor muscle (PA), and hinge (H). The dashed line indicates where the shell should be broken using cutter pliers. (b) Isolation of the ABRM after opening the shells. Dashed line indicates where the ABRM, PBRM, and shell should be cut. String (ST) is tied to the base of the byssus

## Discussion

1. Why does the action potential look biphasic?
2. According to cable theory, the conduction velocity ( $v$ ) increases with the diameter of the axon ( $d$ ) following the equation

$$v = k\sqrt{d}.$$

Compare the data with this equation.

3. (optional) How does the conduction velocity change with temperature?

## 15.3 Byssus Retractor Muscle of *Mytilus*

### Background

Bivalves can close their shells firmly for several hours or even days by contracting their adductor muscle. They are also attached to rocks for days and months using the byssus, a bundle of filaments, through the contraction of the byssus retractor muscle (Fig. 15.4a). During this sustained contraction, the adductor muscle and the byssus retractor muscle exert force practically without spending energy. This distinctive mode of contraction is called catch contraction after the resemblance to the catches used in doors and windows (Twarog 1976; Ishii et al. 1989).

In this section, in order to understand the unique mechanism of catch contraction, we will record the contraction in the anterior byssus retractor muscle (ABRM) of a clam, *Mytilus galloprovincialis*. *Mytilus galloprovincialis* is a species close to *Mytilus edulis*, which is eaten in Europe and North America. We will isolate the ABRM and apply electrical stimuli and neurotransmitters to the muscle to observe the phasic and tonic (catch) contraction. We will also prepare a nerve–muscle preparation to examine the neural control of the contraction of the ABRM by the pedal ganglion.

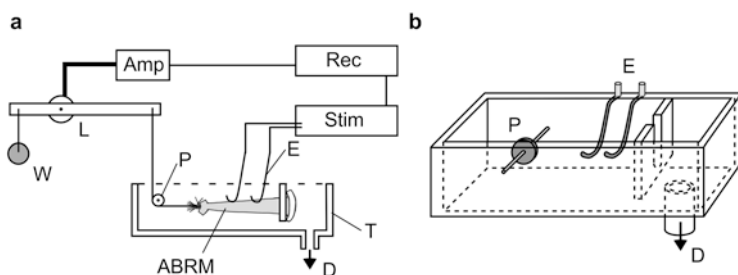
## Material and Methods

Material	<i>Mytilus galloprovincialis</i>
Solutions	ASW (530 mM NaCl, 13.3 mM KCl, 12.6 mM MgCl <sub>2</sub> , 19.5 mM CaCl <sub>2</sub> , 2.6 mM NaHCO <sub>3</sub> , pH 8.0)
	10 <sup>-5</sup> M acetylcholine (ACh) in ASW
	10 <sup>-5</sup> M 5-hydroxytryptamine (5-HT, serotonin) in ASW
Instruments	Isotonic lever transducer with amplifier (we used a lab-made transducer and amplifier, but commercial devices, such as the TD-111 T by Nihon Kohden, HSE-HA by Harvard Apparatus, and MLT7006 by ADInstruments will suffice)
	Recorder (we used the Thermal Arraycorder by Graphtec, but any digital or paper chart recorder will suffice)
	Stimulator that can generate AC (or repetitive pulses) and DC stimulation (we used a lab-made stimulator that attenuates battery and electric transformer outputs, but a commercial instrument, such as the SEN-5201 by Nihon Kohden will suffice)
Items	Trough (we used a trough as shown in Fig. 15.5b, but any devices that can hold the shell will suffice)
	Ag–AgCl electrode (two J-shaped Ag–AgCl wires placed a few millimeters apart), weight, needle, and beaker

## Procedures

### 1. Isolation of the ABRM.

- (a) Break the edge of the shells using cutter pliers to make an opening for inserting a scalpel (broken line in Fig. 15.4a). Insert a scalpel into the opening and cut the posterior adductor muscle (PA in Fig. 15.4a). Then, open the shells by hand.
- (b) Pinch the base of the foot using scissors and pull the foot out in the posterior direction. Cut the byssus short.



**Fig. 15.5** Diagram showing the experimental setup (a) and trough (b). Weight (W), isotonic lever transducer (L), amplifier (Amp), recorder (Rec), pulley (P), stimulator (Stim), electrode (E), trough (T), and drain (D) with stopper are shown. The timing of stimulation is fed from the stimulator to the recorder

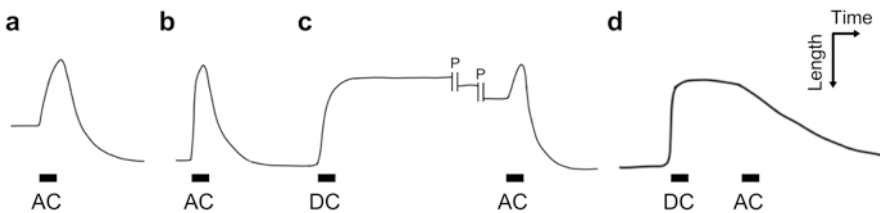
- (c) Scrape the connective tissue and viscera off by pinching the anterior part with scissors and pulling them in the posterior direction.
- (d) Cut off the shell where the anterior end of the ABRM is attached (using cutter pliers, Fig. 15.4b).
- (e) Cut one of the ABRMs and both PBRMs using scissors as indicated by the broken line in Fig. 15.4b.
- (f) Tie a string at the base of the byssus.
- (g) Let the preparation rest in ASW.

## 2. Experimental setup for isolated ABRM.

- (a) Set the ABRM preparation in a trough as shown in Fig. 15.5. Let the electrodes gently touch the muscle.
- (b) Hang an appropriate weight on the isotonic lever to apply tension to the muscle. The force applied to the ABRM will be several tens of grams, but will vary with the size of the preparation.
- (c) Drain the ASW from the trough during the experiment, but let the preparation rest for a few minutes in ASW between experiments.

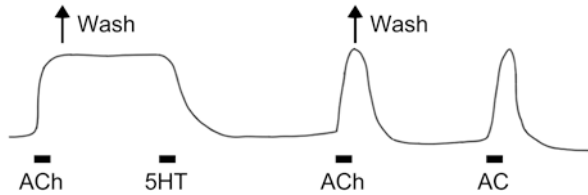
## 3. Response to electrical stimulation on ABRM.

- (a) Start recording and apply AC stimulation. The muscle will become longer than the initial length, indicating that the catch contraction induced during preparation is relaxed by this stimulation (Fig. 15.6a).
- (b) Apply AC stimulation again. A phasic contraction will occur (Fig. 15.6b).
- (c) Apply a single DC stimulation for 2 s. A catch (tonic) contraction will occur (Fig. 15.6c). A slow relaxation can be observed if you wait for several minutes.
- (d) Apply AC stimulation during the catch contraction. The catch contraction will be released after a phasic contraction.

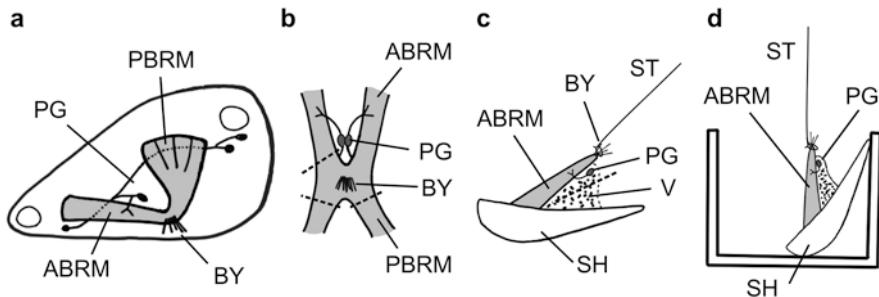


**Fig. 15.6** Typical recordings when electrical stimuli are applied to the anterior byssus retractor muscle (ABRM). (a) Response to AC stimulus applied for the first time after installation to trough. (b) Response to AC stimulus. (c) Response to DC and following AC stimulus. P indicates an interval of a few minutes. (d) The same as panel c but with a reduced AC stimulus intensity





**Fig. 15.7** Typical recording when neurotransmitters are applied to the anterior byssus retractor muscle (ABRM) strip

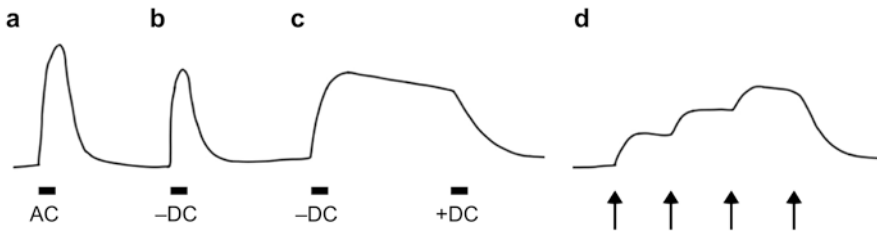


**Fig. 15.8** Nerve–muscle preparation of the pedal ganglion (PG) and anterior byssus retractor muscle (ABRM). (a) Position of the PG. (b) One ABRM and both PBRMs are cut at sites indicated by broken lines. (c) The viscera (V) is cut (broken line) leaving the connection between the pedal ganglion and ABRM intact. (d) Let the shell (SH) lean against the wall of a beaker so that the ABRM stands upright. The string (ST) is connected to the isotonic lever

- (e) Repeat procedure (3) and (4) with decreasing the AC stimulus intensity. Relaxation of the catch contraction will occur without phasic contraction (Fig. 15.6d).

#### 4. Response to neurotransmitters.

- (a) Isolate the ABRM as in ‘Isolation of ABRM’ above, and prepare a 0.5 mm wide strip of ABRM by cutting with scissors. Place the preparation in a trough and connect the string to the lever transducer. Apply tension to the muscle using the weight on the isotonic lever. You will need less weight because the muscle is thinner.
- (b) Apply AC stimulation to relax the ABRM as mentioned in 3 (1).
- (c) Deliver  $10^{-5}$  M ACh solution by dropping directly onto the muscle. Wash the ACh by filling the trough with ASW or by pouring ASW extensively but gently on to the ABRM when the contraction reaches its peak (Fig. 15.7). Drain the ASW.
- (d) Deliver  $10^{-5}$  M 5-HT solution by dropping onto the muscle. The catch (tonic) contraction will relax (Fig. 15.7).



**Fig. 15.9** Responses of the anterior byssus retractor muscle (ABRM) to the stimuli applied to the pedal ganglion. (a) Response to AC stimulation. (b) Response to DC stimulation with negative electrode touching the pedal ganglion (-DC). (c) The same as panel (b) but with reduced stimulus intensity. Stimulus with opposite polarity (+DC) is applied next. (d) Response to mechanical stimulation applied by poking the pedal ganglion with a needle

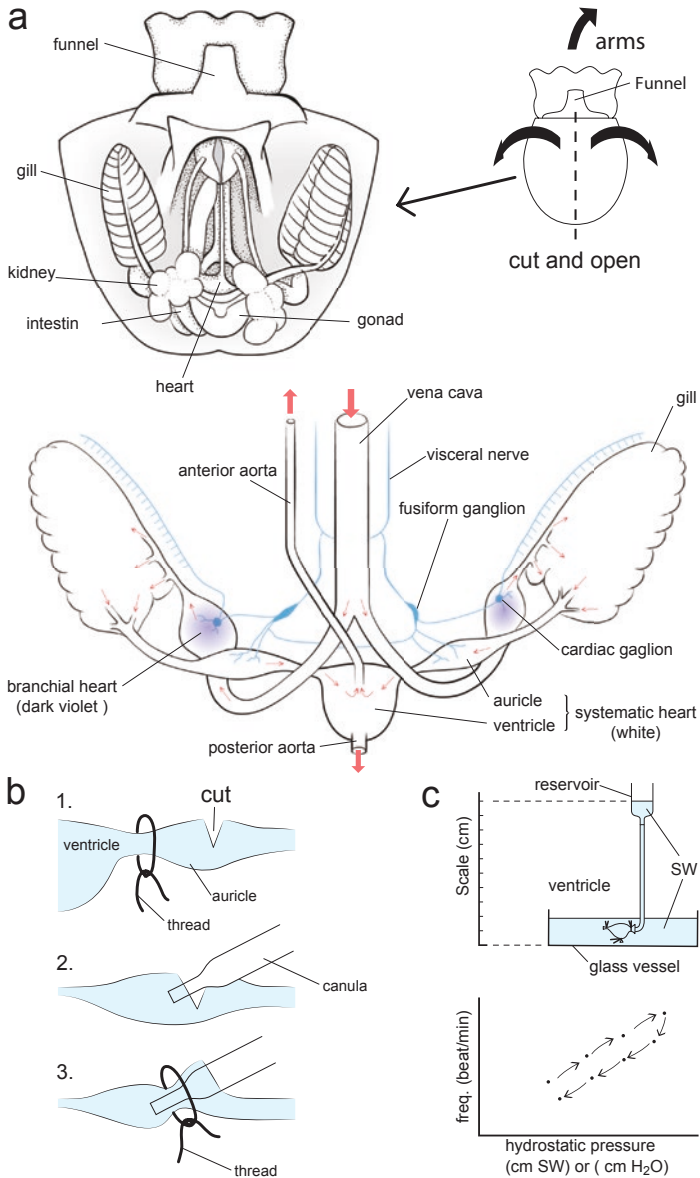
- (e) Apply ACh without washing the remaining 5-HT. Then, wash the muscle with ASW. A phasic contraction will occur because of the remaining 5-HT.
- (f) Apply DC stimulation. A phasic contraction will occur because of the remaining 5-HT.
- (g) Wash the muscle repeatedly with ASW until a tonic contraction can be induced by ACh. Apply tension to the muscle using weight on the isotonic lever.

## 5. Preparation of the nerve–muscle preparation of the pedal ganglion and ABRM.

- (a) Open the shells as mentioned above.
- (b) Remove the viscera while leaving the viscera around the pedal ganglion intact (Fig. 15.8a, b). The pedal ganglion is a pair of ovals located between the two ABRMs when the shells are opened. The color of the pedal ganglion is beige to orange.
- (c) Cut the foot off using scissors.
- (d) Cut off one of the ABRMs and both of the PBRMs.
- (e) Tie a string at the base of the byssus.
- (f) Cut the viscera between the pedal ganglion and shell (Fig. 15.8c).
- (g) Let the shell stand as shown in Fig. 15.8d and connect the string to the lever transducer.

## 6. Electrical stimulation on pedal ganglion.

- (a) Touch the pedal ganglion with one of Ag–AgCl electrodes and touch the viscera with the other.
- (b) Apply AC stimulation to the pedal ganglion and record the contraction. A phasic contraction will occur (Fig. 15.9a).
- (c) Apply DC stimulation while using the electrode touching the ganglion as a negative electrode. A phasic contraction will occur if the stimulus intensity is sufficient (Fig. 15.9b).



**Fig. 15.10** Octopus hearts. **(a)** Ventral view of octopus, showing the arrangement of the systemic heart (one ventricle and two auricles) and two gill hearts. When the mantle is cut along the midline of the ventral side (funnel opening side) and opened (upper right), the visceral space appears with the ventricle at the center under the kidney, with the large gills located at both sides surrounding the space (upper left panel). The systemic heart and two gill hearts are connected (lower panel). **(b)** How to insert a cannula into an auricle. **(c)** Schematic drawings showing the setup to measure the effects of hydrostatic pressure on the heartbeat of the octopus ventricle (left) and an example of data analysis

- (d) Apply DC stimulation with decreasing the intensity. A tonic (catch) contraction will occur at an adequately low stimulus intensity (Fig. 15.9c). If you observe a tonic contraction, apply a DC stimulus with opposite polarity. The tonic contraction will relax.
- (e) Poke the ganglion with a needle. Tonic contraction and relaxation will occur if the appropriate nerve cells are stimulated mechanically (Fig. 15.9d). Since this procedure will damage the ganglion, only perform this experiment at the end.

## Discussion

1. Discuss the properties of the catch contraction.
2. Why does DC and AC stimulation to the ABRM result in catch (tonic) and phasic contraction, respectively?
3. Discuss how the contraction of the ABRM is controlled by the nervous system.

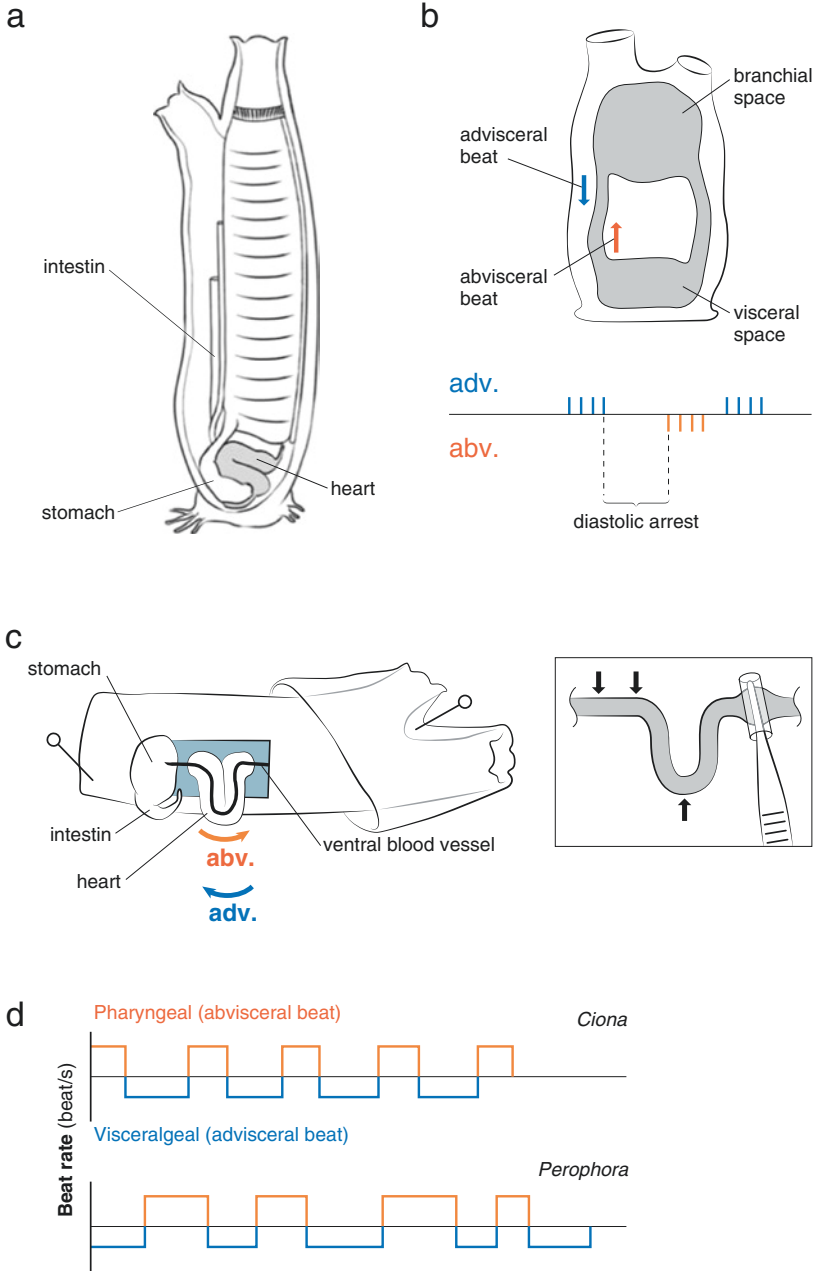
---

## 15.4 Octopus Hearts and Tunicate Hearts

### Background

How materials, such as gas and nutrients, are transported stably and rapidly to their destinations within an animal's body is one of the most significant questions in biology. The evolution of circulation mechanisms brought about large 'explosions' of life in the animal kingdom. The circulatory system requires many steps of development, including the motive force imparted by rhythmic contractions of the heart, which allows the distribution of blood components to every part of the body. Many invertebrates have open vascular systems, which operate at low pressure. In contrast, all vertebrates and some invertebrates, such as cephalopods (octopuses, squids), have closed vascular systems (Wells 1980). This system supports the high-energy demand in cephalopods when escaping rapidly from attacks by predators.

In this section, we will observe and understand the characteristics of the closed and open vascular systems by using the hearts of marine invertebrates, octopus and ascidian, respectively. In the octopus experiment (Fig. 15.10), we will focus on the unique structure of a systemic heart (consisting of one ventricle and two auricles) and its coordinated beating with the gill hearts. By using an isolated ventricle with cannulated auricle, we will measure the effect of hydrostatic pressure on the beating frequency of the ventricle. In the tunicate experiment (Fig. 15.11; Ponc 1982), we will observe the changes in the beating direction of the heart and examine the effects of temperature on the reversal frequency. We will examine how the ligation or obstruction of the flow in the tubular heart by mechanical deformation affects the beat direction and discuss whether pacemakers are involved in the reversal.



**Fig. 15.11** Tunicate heart. Position of the heart in *Ciona* (a) and *Perophora* (b). Bidirectional beating is distinguished as being in the advisceral (toward the visceral space) or abvisceral (away from the visceral space) direction (c). The timing of the reversal of the beating is different among species and environmental conditions, such as temperature (d). The pacemaker region can be identified by applying mechanical deformation to a restricted part along the heart (c, right)

## Material and Methods

Material	<i>Octopus vulgaris</i>
	<i>Ciona intestinalis</i> , <i>Perophora japonica</i>
Solutions	Filtered natural seawater or ASW
Items	Vat
	Chamber
	Scale and holding stand
	Ice water, warm water
	Binocular microscope, micrometer
	Stopwatch

## Procedures

1. Coordination of systemic hearts in octopus.
  - (a) Cut all of the arms off the octopus. Destroy the brain by punching out the head between the eyes with a cork borer (approximately 1 cm in diameter).
  - (b) Place the octopus body in a vat with cold seawater. Open the ventral side (the side on which the funnel emerges) of the mantle by cutting it along the median line (Fig. 15.10a, upper panel). Remove part of the kidney and the whole gonad (testis or ovary) carefully to expose the pulsating systemic heart. Do not mistake pulsating organs for the systemic heart. The systemic heart consists of a ventricle and two auricles located on both sides (right and left) of the auricle. Identify the two gill hearts.
  - (c) Survey the main root of the blood vessels connecting the systemic heart and gill hearts (Fig. 15.10a, lower panel).
  - (d) Measure the beating frequency of each heart independently. Measure the temperature in the chamber when counting the heart rate.
  - (e) Measure the time differences and relationship of beating among each part of the systemic heart. Discuss the coordination of beating in the systemic heart.
  - (f) Measure the beating frequency of the gill hearts and examine whether it affects the systemic heart. Discuss the effect of the gill heartbeat on the coordination of the systemic heart. Consider the significance of the coordination.
  
2. Responses of isolated octopus heart to hydrostatic pressure.
  - (a) After the above coordination experiment, all blood vessels coming out and into the ventricle should be ligated with thread, except for the one auricle mentioned below.
  - (b) A cannula made of a glass capillary is inserted into the auricle through a cut and ligated with thread (Fig. 15.10b).

- (c) The cannula is connected to a tube and the reservoir filled with seawater. Place the ventricle into a chamber filled with seawater. Set the reservoir at the same height as the ventricle.
  - (d) Examine the effect of hydrostatic pressure (expressed in cm SW or cm H<sub>2</sub>O) on the beat frequency by moving the reservoir up and down gradually (Fig. 15.10c). Record the height of the reservoir. Plot the heart rate against the pressure and connect the points in the order of measurement. Discuss the effects of hydrostatic pressure on the beat frequency of the ventricle and also on the appearance of hysteresis.
3. Beat reversal in the tubular heart of a tunicate.
- (a) When using *Ciona* (Fig. 15.11a), the thick tunic has to be removed for the observation of the tubular heart located between the visceral and branchial spaces. For a clearer view, cut a part of the body wall under the tunic and expose a part of the U-shaped heart outside the body (Fig. 15.11c, left). However, you should be careful when handling the organisms. Mechanical stimulation during removal of the tunic may often induce an unstable condition, in which the organism will not change its heartbeat direction for several hours.
  - (b) When using *Perofora* (Fig. 15.11b), although the size of heart is small and needs to be observed by binocular microscope, the hearts can be clearly observed from outside of the body because of its transparent wall.
  - (c) Place the specimen in seawater and observe the direction of flow within the heart or between both ends of the heart. The heartbeat is bidirectional in both *Ciona* and *Perofora*, but the pattern of the changing direction is different. Count the number of flows moving toward the branchial space (abvisceral,  $N_{abv}$ ) and that moving toward the visceral space (advisceral,  $N_{adv}$ ), and calculate the rate of  $N_{abv}/N_{adv}$  (Fig. 15.11c, d).
  - (d) Change the temperature of the seawater and examine the effects of temperature on the rate of reversal of the heartbeat. Discuss the effect of temperature on the bidirectional beating.
  - (e) Identify the pacemaker positions in the *Ciona* heart. Using the part of the heart exposed from the body wall, apply mechanical deformation (pressing, ligating, or cutting) to a restricted area of the U-shaped heart and find the position that can effectively induce a directional change in the heartbeat (Fig. 15.11c, right). Discuss the existence and function of pacemakers: How many are there? Where are they? How do they work?

---

## References

- Ishii, N., Simpson, A. W., & Ashley, C. C. (1989). Free calcium at rest during 'catch' in single smooth muscle cells. *Science*, 243, 1367–1368.

- Ponec, R. J. (1982). Natural heartbeat patterns of six ascidians and environmental effects on cardiac function in *Clavelina huntsmani*. *Comparative Biochemistry and Physiology*, 72, 455–462.
- Twarog, B. M. (1976). Aspects of smooth muscle function in molluscan catch muscle. *Physiological Reviews*, 56, 829–838.
- Wells, M. J. (1980). Nervous control of the heartbeat in octopus. *Journal of Experimental Biology*, 85, 111–128.





Yukitoshi Katayama, Takashi Kitahashi, Nobuo Suzuki,  
and Tatsuya Sakamoto

## Abstract

One of major topics in endocrinology continues to be environmental adaptation, and teleost fishes have been the subject of intensive research. Teleost fish have experienced in their evolution an additional third-round whole genome duplication just after the divergence of their lineage, which endowed them with an extra adaptability to invade various aquatic habitats from fresh water to the deep-sea floor. Thus, their endocrine system for environmental adaptation is also diverse. Here, we introduce the marine teleost as a model to study experiments on the adaptation, particularly body fluid regulation by dipsogenic hormones (e.g., angiotensin II) and hypocalcemic hormones (e.g., calcitonin, stanniocalcin) and body color regulation by melanin-concentrating hormone, melanocyte-stimulating hormone, and melatonin.

---

Y. Katayama (✉)

Atmosphere and Ocean Research Institute, The University of Tokyo, Tokyo, Japan  
e-mail: [katayama3g@aori.u-tokyo.ac.jp](mailto:katayama3g@aori.u-tokyo.ac.jp)

T. Kitahashi

Sado Marine Biological Station, Niigata University, Niigata, Japan

N. Suzuki

Noto Marine Laboratory, Kanazawa University, Kanazawa, Japan

T. Sakamoto

Ushimado Marine Institute, Faculty of Science, Okayama University, Okayama, Japan

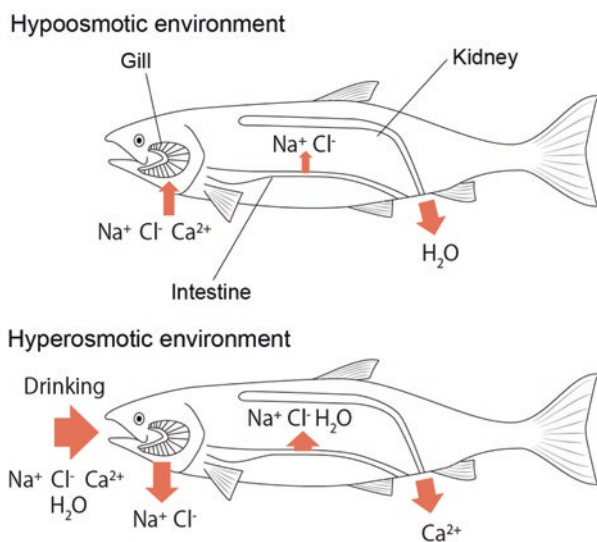
## 16.1 Overview

One of major topics in endocrinology continues to be environmental adaptation, and teleost fish have been the subject of intensive research (Schmidt-Nielsen 1997). Here, we introduce the marine teleost as a model for experiments on adaptation, particularly the regulation of body fluid and color by some hormones.

## 16.2 Body Fluid Regulation

Although ample studies of body fluid regulation have been performed on tetrapods, particularly mammals, fish are more vulnerable to body fluid changes; their extracellular fluids are in close contact with environmental water of varying salinities across the thin respiratory epithelia of the gills. Thus, the gills are the primary body fluid regulatory organ for teleost fish, where the active uptake and excretion of ions occur against the concentration gradients imposed by environmental water. In addition to the gills, the major regulatory sites are the drinking and subsequent absorption of ions and water by the intestine, particularly for the acquisition of water in hyperosmotic water, and the kidney, where copious amounts of urine and divalent ions are excreted in hypoosmotic and hyperosmotic water, respectively (Fig. 16.1).

These mechanisms are maximally flexible in euryhaline species, which experience drastic salinity changes and must switch ion and water regulation to achieve opposite directions of active transport. Thus, the mechanisms have been the subject of intensive



**Fig. 16.1** Major ion/water movement at the body fluid regulatory sites of teleost fish. The gills, intestine, and kidney are the major regulatory organs in teleosts. The size of the arrow shows the amount of ion/water movement. For further details, see our review (Takei et al. 2014)

research. These studies have revealed that various hormones play pivotal roles in adaptation to fluctuating environmental salinities (Katayama et al. 2018b). The growth hormone/insulin-like growth factor I axis and angiotensin II promote acclimation to seawater, whereas prolactin promotes acclimation to hypoosmotic water, and cortisol has a dual function; calcitonin acts to reduce blood calcium, opposing the effects of the parathyroid hormone. However, a broad generalization that holds for all teleosts is unlikely. Other hormones, such as neurohypophysial hormones, natriuretic peptides, and stanniocalcin also have distinct effects on body fluid regulation in different teleost species. We assume that such diversity in hormonal actions among species stems from their intrinsic differences in body fluid regulation that originated from their native habitats, either freshwater or seawater (Takei et al. 2014). Several experiments have been designed to analyze the hormonal effects, not only on the muscle water content (changes in muscle water content are inversely related to changes in plasma osmolality, sodium, and chloride in many teleost species), but also on chloride cells or ionocytes in the gills (Sakamoto et al. 2016).

---

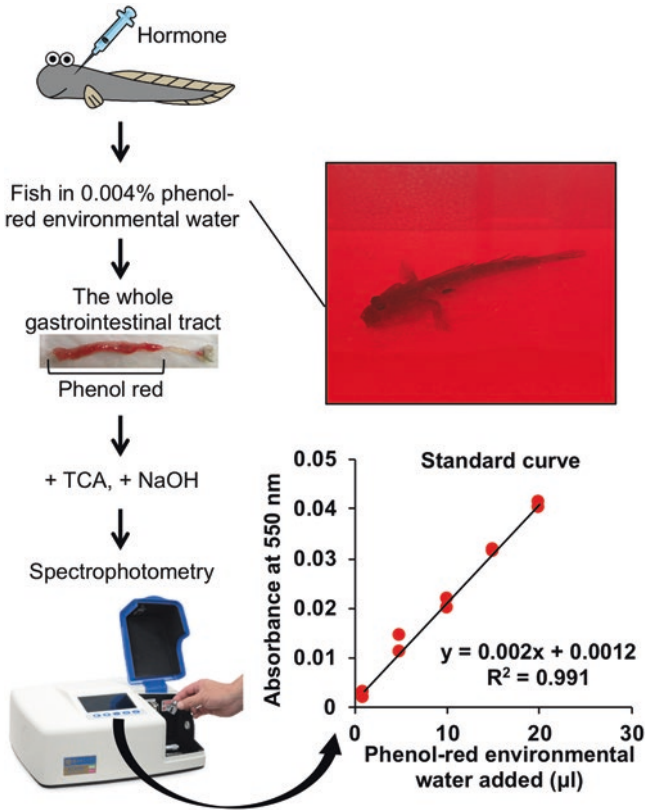
### 16.3 Experiment 1: Drinking

In desiccating environments, both on land and in the ocean, animals must cope with dehydration. The major route for water acquisition is by oral drinking in terrestrial tetrapods and marine fish (represented by teleosts as they are dehydrated in seawater). Angiotensin II (Ang II) in the renin–angiotensin system is the most potent dipsogenic hormone known thus far in many vertebrate species. In teleosts, Ang II induces drinking in euryhaline fish, which can become dehydrated by entering water of a higher osmotic concentration than that of the environment where they typically live. In contrast, Ang II does not stimulate drinking in fish that live exclusively in either freshwater or seawater, conditions under which osmotic changes rarely occur. Neurohypophysial hormones, such as isotocin and vasotocin, regulate drinking behaviors in some fish, but great differences in hormonal actions have been found among species (Katayama et al. 2018b). Such differences may reflect the osmoregulatory environments that each species has experienced during their evolution. Here, we describe an experiment to show the effects of hormones on the amount of water ingested (Katayama et al. 2018a).

**Solution** 0.004% phenol red–environmental water, 0.01% tricaine methanesulfonate–environmental water (neutralized with sodium bicarbonate), 5% trichloroacetic acid, 1 N NaOH.

#### Methods (Fig. 16.2)

1. Fish (weighing about 10 g) injected with a vehicle (e.g., saline) or vehicle plus hormones (e.g., Ang II) are immersed in the phenol red–environmental water for 30–60 min before the phenol red in the intestine may flow out from the vent, in the case of longer immersions.



**Fig. 16.2** Measurement of the ingested water amount using phenol red. A fish (e.g., *Periophthalmus modestus*) is immersed in 0.004% phenol red–environmental water. The graph indicates a standard curve for the quantification of ingested phenol red–water. TCA, trichloroacetic acid. For further details, see “Method”

2. After fish are anesthetized with tricaine methanesulfonate and killed, the whole digestive tract is removed and cut open into a Petri dish.
3. Saline solution (1 ml) is added to the dish. Phenol red is thoroughly washed from the digestive tract and the wash is transferred into a centrifuge tube. For a standard curve, separate saline solutions (1 ml) where the phenol red–environmental water (e.g., 1, 5, 10, 15, and 20 µl) are added are also transferred into 1.5 ml centrifuge tubes.
4. After mixing and mild centrifugation, an aliquot (500 µl) of the supernatant is transferred into a centrifuge tube containing 500 µl of 5% trichloroacetic acid for the removal of biological materials.
5. After mixing and centrifugation ( $10,000 \times g$ , 5 min), the supernatant is transferred into a centrifuge tube containing 500 µl of 1 N NaOH.
6. The mixture is centrifuged ( $10,000 \times g$ , 5 min) and the supernatant is taken for spectrophotometry with a microplate reader for phenol red at 550 µm.

7. The volume of ingested water and the amount of phenol red in the digestive tract are calculated from the standard curve.

---

## 16.4 Experiment 2: Calcium Metabolism

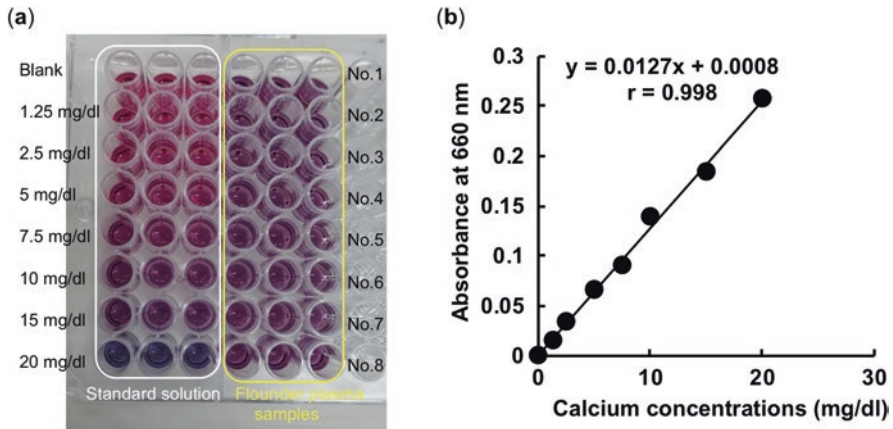
Calcium is an alkaline earth metal, and it appears in nature as a divalent cation. Calcium is relatively abundant in the lithosphere and hydrosphere; it is present in several mineral components of rocks and as dissociated calcium ions in oceans, lakes, and rivers. This cation is an essential mineral for maintaining cell viability and, ultimately, life. Therefore, in all vertebrates, including both terrestrial and aquatic species, blood calcium levels are strictly kept at a constant concentration (around 2.5 mM). To maintain this blood calcium level, a variety of calcemic hormones play significant roles. In marine fish living in calcium-rich environments, hypocalcemic hormones, such as calcitonin and stanniocalcin, may have significant roles in the excretion of extra calcium from the gills and kidneys. On the other hand, fish in freshwater, where the calcium level is low, may utilize hypercalcemic hormones (parathyroid hormone and prolactin) to help maintain adequate concentrations of calcium in their bodily fluids. To understand calcium regulation in marine fish, the plasma calcium level must be measured. A method for measuring plasma calcium concentrations using a microplate reader is described below.

**Solution** 0.04% 2-phenoxyethanol environmental water, Aqua-auto Kainos Calcium Reagent Kit (Kainos Laboratories, Inc., Tokyo, Japan).

### Methods

Measurement of plasma calcium concentrations using a microplate reader:

1. After marine fish are anesthetized with 2-phenoxyethanol, blood samples are then collected from the caudal vessel of individual anesthetized fish using a heparinized syringe. The collected blood is placed in a 1.5 ml tube.
2. The tube is centrifuged at 15,000 rpm for 3 min. The separated plasma is then immediately frozen and kept at  $-80^{\circ}\text{C}$  until use.
3. The total calcium level (mg/100 ml) of the separated plasma is determined using the Aqua-auto Kainos Calcium Reagent Kit. Calcium in the plasma samples binds to a color coupler (Arsenazo III) and forms a blue complex under a neutral pH. The blue color is proportional to the calcium concentration. You can measure the plasma calcium levels by colorimetry using this color development.
4. Add 4  $\mu\text{l}$  of plasma to 360  $\mu\text{l}$  of reaction solution and then place 100  $\mu\text{l}$  in a microplate well (Fig. 16.3a).
5. You can measure the absorbance at 660 nm using a microplate reader. Calcium standard solutions (1.25, 2.5, 5, 7.5, 10, 15, and 20 mg/100 ml) are used to prepare the standard curve, from which the calcium concentration of the unknown plasma sample can be calculated (Fig. 16.3b).



**Fig. 16.3** (a) Colored reaction solution in microplate and (b) standard curve for the measurement of plasma calcium. Data for the standard curve indicate the mean of triplicated samples

## 16.5 Body Color Regulation

The body colors of marine animal species can vary according to their surrounding environments. Fish swimming in relatively shallow areas of the ocean often exhibit blue/green or black backs and light/whitish bellies, whereas most bottom-dwelling fish will match the color of the rock/sand in their habitat. The body coloration is generally generated by chromatophores in the skin. Chromatophores are cells containing pigment granules termed melanophores (black), erythrophores (red), xanthophores (yellow), or leucophores (white), depending on the color of their pigments. The type of chromatophore and their distribution in the body determine the color pattern of an individual fish. Moreover, the body color of individuals can be further modified according to the surrounding light environment and physiological states of the individual through endocrine/neural regulation of the chromatophores.

## 16.6 Experiment 3: Movement of Pigment Granules in Chromatophores

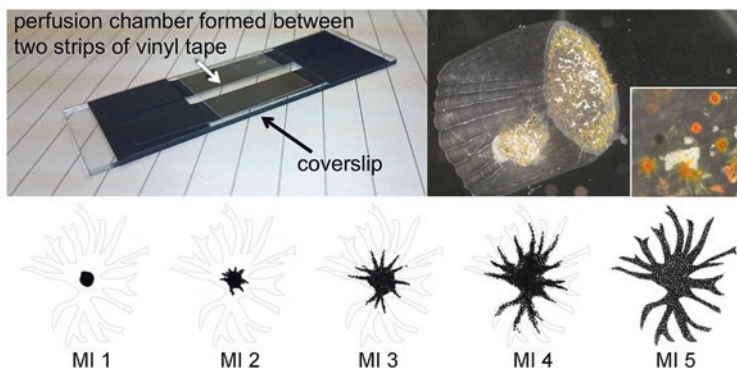
As well as neurotransmitters (e.g., noradrenaline), hormones, such as melanin-concentrating hormone and melanocyte-stimulating hormone from the pituitary, and melatonin from the pineal gland, are involved in the multiplex control of aggregation and dispersal of pigment granules through specific receptors expressed on the chromatophore surface. The movement of pigment granules in chromatophores can be easily observed under a light microscope using fish scales.

**Solution** Ringer's solution (NaCl 7.32 g, KCl 0.20 g,  $\text{CaCl}_2 \cdot 2\text{H}_2\text{O}$  0.265 g,  $\text{MgCl}_2 \cdot 6\text{H}_2\text{O}$  0.37 g, Tris-HCl buffer [1 M, pH 7.4] 5 ml, D-glucose 1.0 g/1 L).

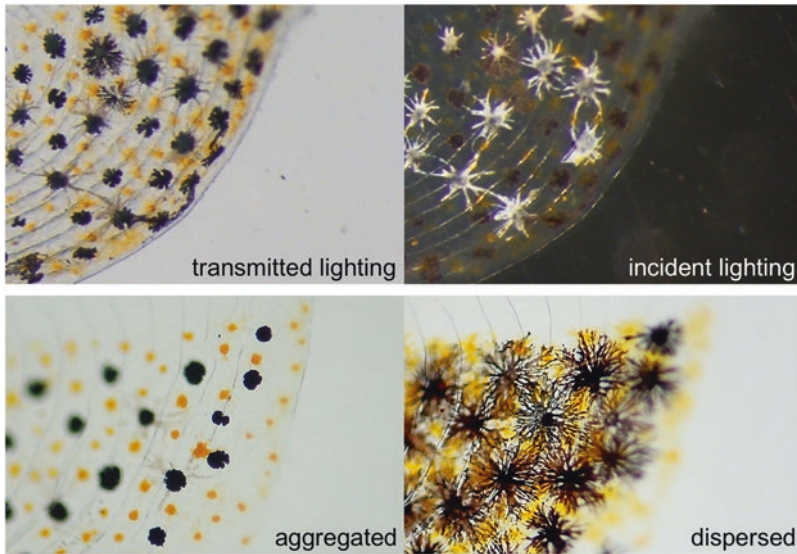
## Methods

1. Prepare dilutions of the hormone of interest in Ringer's solution and use them as test solutions.
2. Isolate several fish scales from the dorsal part of the fish body using fine forceps and keep them in Ringer's solution for longer than 5 min.
3. Place a scale on the center of a glass slide equipped with two strips of sticky tape (Fig. 16.4; you may use a small drop of Vaseline to immobilize the scale).
4. Place a drop of Ringer's solution on the scale and cover it with a coverslip (a perfusion chamber filled with Ringer's solution is formed).
5. Observe chromatophores on the scale under a light microscope. Pigment granules might be completely dispersed or aggregated depending on the type of chromatophore (Fig. 16.5).
6. Place a drop of a test solution on one side of the perfusion chamber and remove the excess solution from the other side using a small piece of filter paper. Quickly repeat this action two to three times to completely replace the solution inside the perfusion chamber.
7. Score the degree of pigment dispersal in chromatophores using the melanophore index every 30 sec for about 5 min (Fig. 16.4). Score the average of the whole scale rather than a particular chromatophore. Taking photos of the scale at each time point will make it easy to review the movement of pigment granules later.
8. Repeat steps 6 and 7 with Ringer's solution and observe the changes in the opposite direction.
9. Repeat steps 6–8 with another test solution.

**Notes** The number and type of chromatophores in a scale differ in different areas of the fish body. Furthermore, as the reaction of a chromatophore to a particular hormone is determined by the type of receptors expressed on the cell surface, scales from different species or even from different body areas of a fish



**Fig. 16.4** Glass slide for scale observation, rockfish scale, and melanophore index. In the rockfish scale, melanophores, xanthophores, and leucophores can be observed. The dispersal of pigment granules should be scored using the melanophore index (MI)



**Fig. 16.5** Difference in lighting and dispersal of pigment granules. Melanophores and xanthophores can be observed using transmitted lighting, while leucophores often require incident lighting. Note that the leucophores look grayish with transmitted lighting and thus are difficult to distinguish from melanophores. The dispersal of pigment granules in the melanophores and xanthophores makes the body color darker. Scales from the medaka, *Oryzias latipes*

may provide different results in this experiment. Damaged chromatophores often stay in an aggregated or hyperdispersed state.

## References

- Katayama, Y., Sakamoto, T., Saito, K., et al. (2018a). Drinking by amphibious fish: Convergent evolution of thirst mechanisms during vertebrate terrestrialization. *Scientific Reports*, 8, 625.
- Katayama, Y., Sakamoto, T., Takanami, K., et al. (2018b). The amphibious mudskipper: A unique model bridging the gap of central actions of osmoregulatory hormones between terrestrial and aquatic vertebrates. *Frontiers in Physiology*, 9, 1112.
- Sakamoto, T., Yoshiki, M., Takahashi, H., et al. (2016). Principal function of mineralocorticoid signaling suggested by constitutive knockout of the mineralocorticoid receptor in medaka fish. *Scientific Reports*, 6, 37991.
- Schmidt-Nielsen, K. (1997). *Animal physiology: Adaptation and environment*. Cambridge: Cambridge University Press.
- Takei, Y., Hiroi, J., Takahashi, H., et al. (2014). Diverse mechanisms for body fluid regulation in teleost fishes. *American Journal of Physiology. Regulatory, Integrative and Comparative Physiology*, 307, R778–R792.





Yasuhisa Henmi and Seiji Arakaki

## Abstract

Behavior refers to the responses of organisms to internal and external stimuli. As a method of adaptation, organisms react to both their environment and other organisms. Consequently, we can observe various types of behaviors, such as attracting a mate, finding a suitable habitat, feeding, and predator avoidance in different species and individuals. In this section, we describe the practical methods for learning about behavioral ecology. Behavioral ecology includes the study of animal behavior due to ecological pressures. Individuals with traits that provide selective advantages in their environments maximize their gene contribution to future generations. Because an individual's success at survival and reproduction depends critically on its behavior, selection tends to favour individuals that are efficient at foraging, mating, habitat selection, and so on. Ecological and evolutionary processes explain the occurrence and adaptive significance of behavior patterns.

There are various types of behaviors in marine animals, such as attracting a mate, finding a suitable habitat, feeding, and predator avoidance in different species and individuals. Our program focuses on the behavior of animals in intertidal habitats (especially macrobenthos greater than 1 mm in size). Benthos is a general term for organisms that live on, in, or near the seabed. The intertidal zone is a useful area for studying the behavior of marine animals because of its high accessibility and the ease of observation during low tide. Tidal and wave actions cause a vertical emersion gradient of increasing exposure to air from the low to high shore. Intertidal habitats are exposed routinely to both marine and terrestrial

---

Y. Henmi (✉)

Center for Water Cycle, Marine Environment and Disaster Management, Kumamoto University, Kumamoto, Japan

e-mail: [henmi@gpo.kumamoto-u.ac.jp](mailto:henmi@gpo.kumamoto-u.ac.jp)

S. Arakaki

Amakusa Marine Biological Laboratory, Kyushu University, Kumamoto, Japan

conditions and impose high levels of stress on the marine and terrestrial species that inhabit them. For example, air and water temperatures vary greatly during low tide, especially in high intertidal areas. Therefore, all species in this zone must adapt to various stresses (e.g., heat and drought), and so their activity patterns often show tidal rhythm. We give some examples of intertidal marine animal behavior; shell use by sympatric hermit crabs, reproductive behavior of fiddler and bubbler crabs, habitat selection in tide pool fishes, and movement pattern of intertidal organisms.

---

## 17.1 Activity Preparation

1. Preparing to enter intertidal areas
  - (a) Get permission to enter the area and collect animals and plants: in some areas (e.g., fishing areas), access/collection is not allowed.
  - (b) Check the tide time and height: the tidal information can be obtained online (<https://www.tide-forecast.com/countries>).
  - (c) Pay attention to dangerous organisms, including toxic crabs and octopuses.
  - (d) Watch your step on slippery or sharp substrates in the field.
  - (e) Be sure to drink a good amount of water to avoid sunstroke.
2. Essential or useful survey tools
  - (a) Hat—breathable, UV-cut, and waterproof fabric;
  - (b) Long-sleeved shirt, long pants—breathable, UV-cut, and waterproof fabric;
  - (c) Boots—long, breathable; sneakers are useful in rocky or sandy areas;
  - (d) Folding scale, tape measure—rust-proof, plastic, or fabric;
  - (e) Vernier caliper—rust-proof or plastic;
  - (f) Stopwatch—waterproof, battery operated (solar-powered watches are often unstable);
  - (g) Data sheet, field book—waterproof paper;
  - (h) Binoculars—waterproof, types with short focus distance are very useful for small animals;
  - (i) Oil ball-point pen, oily felt-tip pen—usable on wet paper;
  - (j) Mobile phone—for emergency contact (save the phone number for water rescue);
  - (k) Zip lock plastic bags—various sizes.

---

## 17.2 Shell Use by Sympatric Hermit Crabs

There are various types of behaviors in marine animals (Fig. 17.1). In this section, we focus on the shell use by sympatric hermit crabs. Hermit crabs belong to one group (superfamily Paguroidea) of decapod crustaceans and can be found from the land to deep sea (Fig. 17.2, McLaughlin et al. 2010). In most species, their abdomens are long, spirally curved, and soft, unlike those of most other crustaceans (Fig. 17.3). They protect their vulnerable abdomens from predators and competitors



**Fig. 17.1** Various behaviors of macrobenthic animals. (a) Deposit feeding: *Batillaria attramentaria*, (b) filter feeding: *Ruditapes philippinarum*, (c) predation: *Helice tridens* eating *Macrophthalmus japonicus*, (d) predation: *Acanthaster planci* prey on *Acropora* corals, (e) scavenging: *Nassarius festivus* eating *Meretrix lusoria*, (f) drove formation: *Mictyris brevidactylus*, (g) fighting: *Austruca lactea*, (h) threatening: *Dasyatis akajei*, (i) courtship: *Macrophthalmus banzai*, (j) courtship: *Boleophthalmus pectinirostris*, (k) female-guarding: *Philyra pisum*, (l) mating: *Helicana japonica*, (m) spawning: *Hemifusus tuba*, (n) nest-guarding: *Bathygobius fuscus*, (o) symbiosis: *Amphiprion perideraion* and sea anemone, (p) symbiosis: *Paranthus sociatus* on *Nassarius festivus*, (q) parasitism: *Peregrinamor oshimai* on *Upogebia major*, (r) parasitism: *Nerocila japonica* on *Lateolabrax latus*. Photos by Y. Henmi (a-c, e-m, p, q), S. Arakaki (d, n, o, r)

by using empty gastropod shells, into which their bodies can be retracted. As the crabs grow, they required larger shells. However, suitable shells are usually limited. So many crabs use shells that are too small or large (Fig. 17.4). Crabs with too small shells, however, cannot grow fast and ones with too large shells may be vulnerable to predators or competitors. Moreover, some shells are unsuitable because they are too old and/or broken. Consequently, intense competition for suitable empty or others' shells occurs among crabs of the same or different species.

On the rocky shores of Kyushu, Japan, three species of the genus *Pagurus* are dominant (*P. minutus*, *P. filholi*, and *P. lanuginosus*; Fig. 17.5). Though they use the shells of many species (Fig. 17.6), each species has its favorite gastropod species. For example, many *P. minutus* use the shells of *Batillaria attramentaria* and many *P. filholi* use those of *Monodonta labio*, even if these shells are rare (Fig. 17.7).

## Objective

The aims of this experiment are to characterize the patterns in gastropod shell occupation in the field and in shell type choice (species, size) under laboratory conditions by hermit crabs. The following questions are to be answered:

1. Which do crabs prefer better, shells with no sand/sand inside?
2. What gastropod's shell does each hermit crab species use in the field?
3. Can each crab use their favorite size and species of shell?
4. Do larger crabs have an advantage in a fight?
5. When do fight for shells escalate?

## Methods

### 1. Collection and maintenance of specimens

Before the experiments, you need to collect hermit crabs and gastropod shells from the shore. In the laboratory, crabs should be kept in groups in large tanks filled with seawater. If there are not enough empty shells, you need to make an abundance of empty shells of various type (size, species) by boiling them and removing the soft bodies. On the rocky shores of Kyushu, Japan, the following hermit crabs and gastropod snails are dominant.

#### (a) Dominant hermit crabs

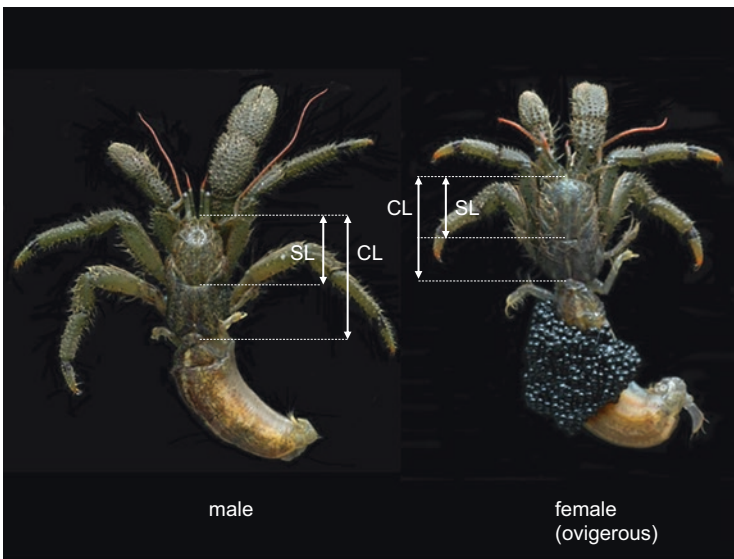
- *Pagurus minutus* (Fig. 17.5a): carapace length (CL) 12 mm, shield length (SL) 5 mm; common in middle to lower intertidal flats, also in tide pools on rocky shores; black-striped brown legs, striped antennae, long dactylus.
- *P. filholi* (Fig. 17.5b): CL 10 mm, SL 6 mm; common in middle to lower intertidal rocky shores; olive carapace, white tips of walking legs.
- *P. lanuginosus* (Fig. 17.5c): CL 12 mm, SL 5 mm; common in lower intertidal rocky shores; red antennae and hairy claws and walking legs.

#### (b) Main gastropod species used by dominant hermit crabs

- *Monodonta labio* (Fig. 17.6a): shell height (SH) 20 mm; common in middle to lower intertidal rocky shores; round, heavy, thick, solid, and conical shell.



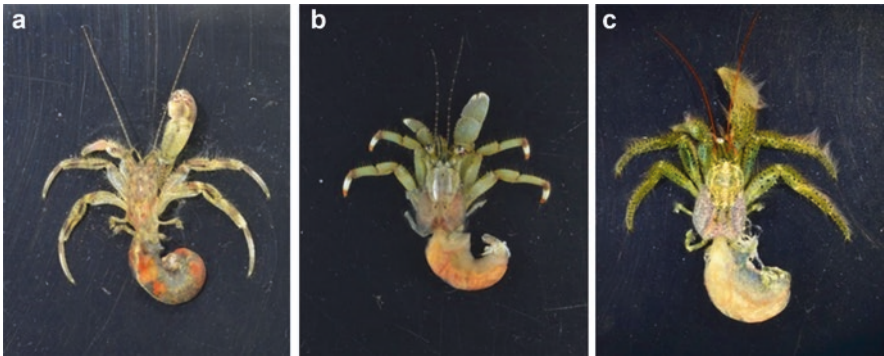
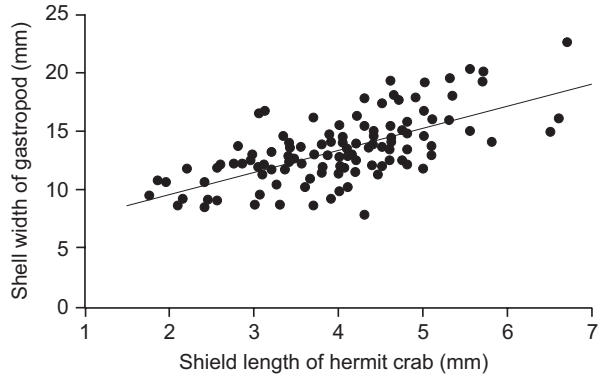
**Fig. 17.2** *Pagurus minutus* in the shell of *Laguncula pulchella*. Photos by Y. Henmi



**Fig. 17.3** *Pagurus nigrofascia*. CL carapace length, SL shield length. Photos by S. Mishima

- *Umbonium moniliferum* (Fig. 17.6b): shell width (SW) 20 mm; sandy tidal flats; small, flattened shell, variable coloration.
- *Lunella coronata* (Fig. 17.6c): SW 25 mm; common both in intertidal rocky shore and tidal flats; flattened shell.
- *Chlorostoma lischkei* (Fig. 17.6d): SH 27 mm; intertidal and subtidal rocky shore; round, uneven shell.
- *Batillaria attramentaria* (Fig. 17.6e): shell length (SL) 30 mm; common in tidal flats; long, acute shell.

**Fig. 17.4** Regression analysis between shield length (mm) of hermit crab *Pagurus filholi* and shell width (mm) of gastropod *Lunella coronatus* used by each crab in Amakusa, Kumamoto, Japan (Y. Henmi unpublished data)



**Fig. 17.5** *Pagurus minutus* (a), *P. filholi* (b) and *P. lanuginosus* (c). Photos by Y Henmi

- *Reishia clavigera* (Fig. 17.6f): SL 30 mm; intertidal rocky shore and quays; conical shell with many large verrucae.

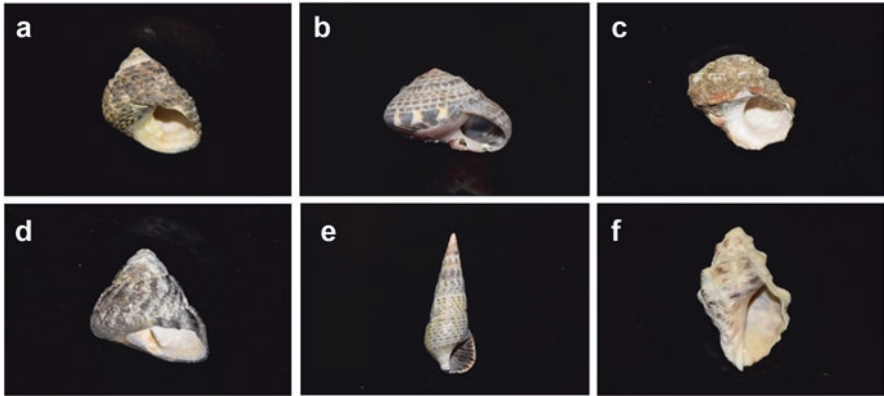
## 2. Shell preference

(a) Shells with sand inside: Two shells of the same size (e.g., *L. coronatus*) without holes and fragments are prepared. For one shell, sand is poured into the shell aperture and the shell is rotated in an anticlockwise fashion to force sand deep into the shell interior. The shells are placed in the experimental arena and one naked crab is added. Observe the behavior of the crab and which shell it chooses.

(b) Shell type (size, species): Shells of various types (different species or different sizes) are placed in the experimental arena and one naked crab is added. Prior to the experiments, SH, SW, and SL (or shell weight) of the gastropod shells, are measured, and the SLs or naked body weights are measured for crabs. Examine the preferred shell species and the preferred shell size of each hermit crab.

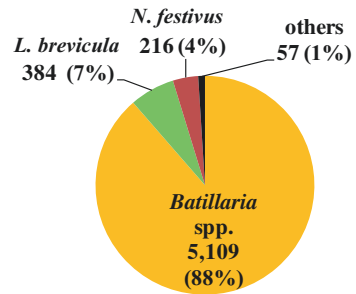
## 3. Fighting over shells

(a) Body size: Two naked crabs of different body sizes are placed in the arena. The preferred size of shell for the larger crab is then placed in the arena.



**Fig. 17.6** *Monodonta labio* (a), *Umboonium moniliferum* (b), *Lunella coreensis* (c), *Chlorostoma lischkei* (d), *Batillaria attramentaria* (e) and *Reishia clavigera* (f). Photos by Y. Henmi

**Fig. 17.7** Shell species used by hermit crab *Pagurus minutus* of both sexes in Makinohana, Fukuoka, Japan. *Batillaria* spp. (*B. attramentaria* and *B. multiformis*), *Littorina brevicula*, *Nassarius festivus* and others (modified from Mishima 2010)



Observe the behavior of the crabs and which crab gets the shell. If the body size of the crabs is similar, does the fight escalate?

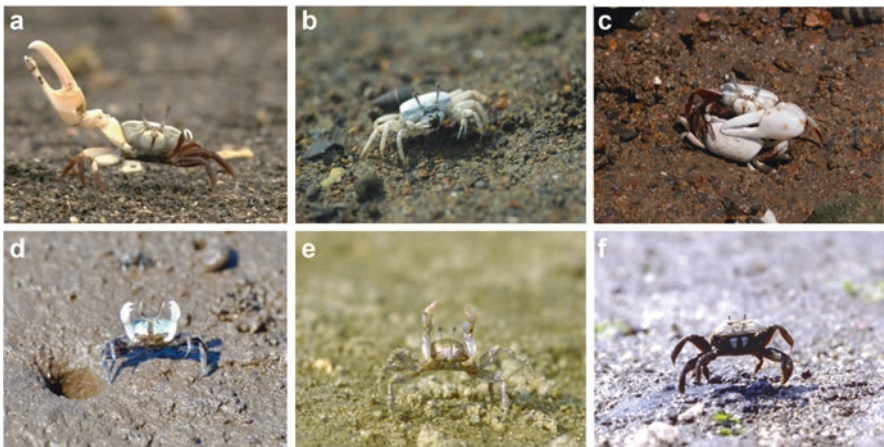
- (b) Crab species: Is there superiority among species in fights for preferred shells? Two naked crabs of different species with the same body size are placed in the arena and the preferred size shell is placed between the crabs. Observe this interaction for various combinations of species (Fig. 17.8).

### 17.3 Reproductive Behavior of Fiddler and Bubbler Crabs

This program focuses on the waving, foraging, and fighting behavior of intertidal crabs (fiddler crab *Austruca lactea*, bubbler crabs *Ilyoplax pusilla* and *Scopimera globosa*, and so on) in the superfamily Ocypodoidea (Fig. 17.9). Fiddler and bubbler crabs are familiar animals on intertidal flats. They live in dense, mixed-sex populations, and each crab digs an isolated burrow and forages near the burrow opening during daytime low tides. Fiddler crabs are most well known for their sexually dimorphic claws; one of the claws is much larger than the other in males, while the females' claws are both small. On the other hand, male and female bubbler crabs



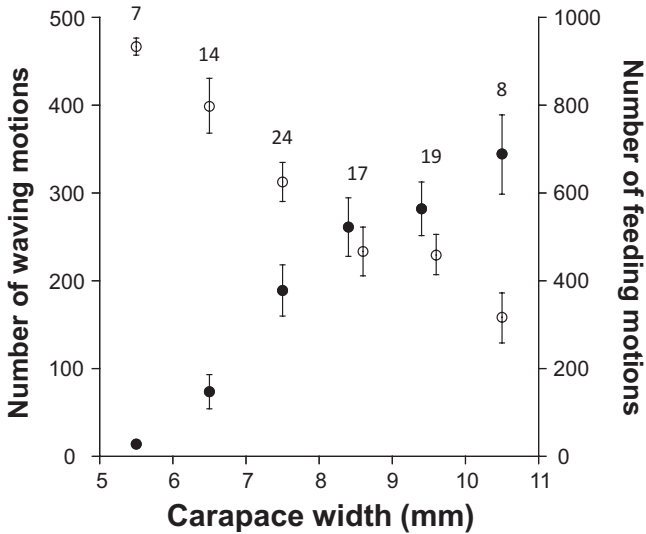
**Fig. 17.8** Battle of *Pagurus minutus* in an experimental plastic arena (11.5 × 15 cm, depth 8 cm, seawater 2 cm depth). Photo by Y. Henmi



**Fig. 17.9** Fiddler crab *Austruca lactea* (**a-c**; **a**: waving male, **b**: feeding female, **c**: surface copulation) and bubbler crabs *Ilyoplax pusilla* (**d**: waving male) and *Scopimera globosa* (**e**: waving male) and mud crab *Macrophthalmus japonicus* (**f**: waving male). Photos by Y. Henmi

possess similar-sized left and right claws; however, males have much larger claws than females in most species, and this trend is magnified in larger crabs. During the reproductive season, male crabs of some species perform waving displays, the rhythmic movement of claws, to attract wandering females into their burrows. Waving is very costly; however, males invest large amounts of time and effort in this behavior because the waving performance strongly influences reproductive outcome. However, small males spend their time not on waving displays but on foraging because of low mating opportunities; mating success is much higher for larger males (Fig. 17.10).





**Fig. 17.10** Number (mean  $\pm$  SE) of waving motions (closed circles) and feeding motions (open circles) per 10-min surface activity in each size class of male *Ilyoplax pusilla*. Number of males examined is shown above the circles. Modified from Kawano and Henmi (2016)

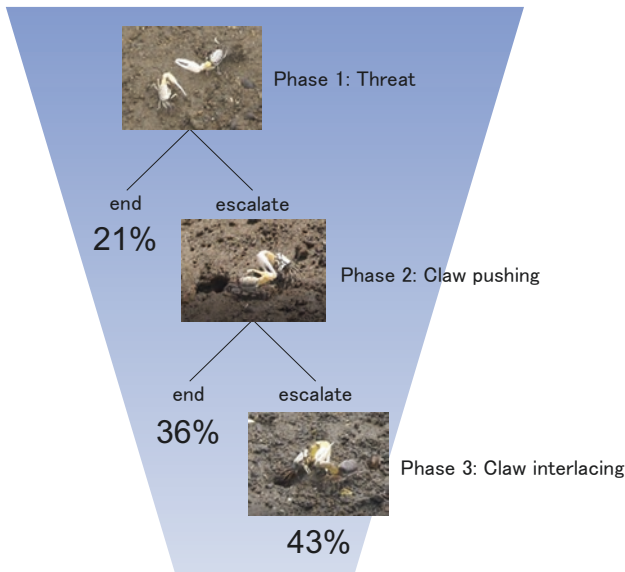
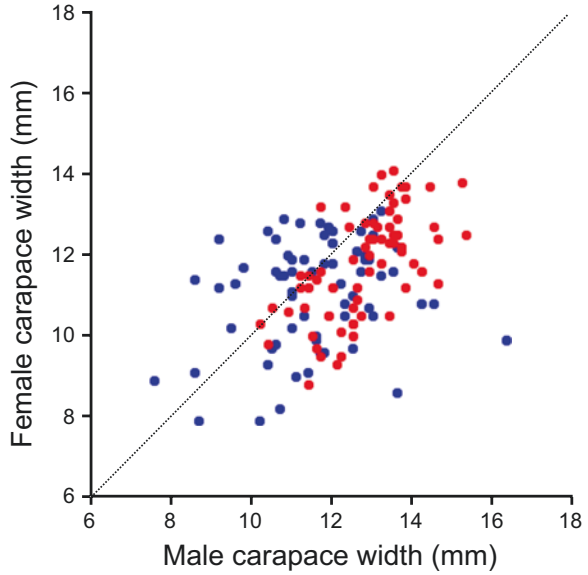
In Ocypodoidea, two types of mating tactics are observed: underground mating and surface mating (Murai et al. 1987; Henmi et al. 1993). In underground mating, mating is conducted in the burrow of the male. In surface mating, males mate with nearby resident females on the ground surface (Fig. 17.9c). Some species conduct underground mating (e.g., *I. pusilla*) or surface mating (e.g., *Macrophthalmus abbreviatus*) only, while other species conduct both types of mating (e.g., *A. lactea*, *S. globosa*, and *Macrophthalmus japonicus*). In *A. lactea*, small males conduct mainly surface mating (Fig. 17.11, Henmi, unpublished data). For most species, the burrows are a critical resource, providing shelter from tidal inundation, heat, desiccation, and predators. In many species, mating occurs in the burrows and females incubate their broods in them until hatching. Therefore, fighting over a burrow often occurs between the resident (burrow holder) and an intruder (non-burrow holder) (Fig. 17.12).

### Objective

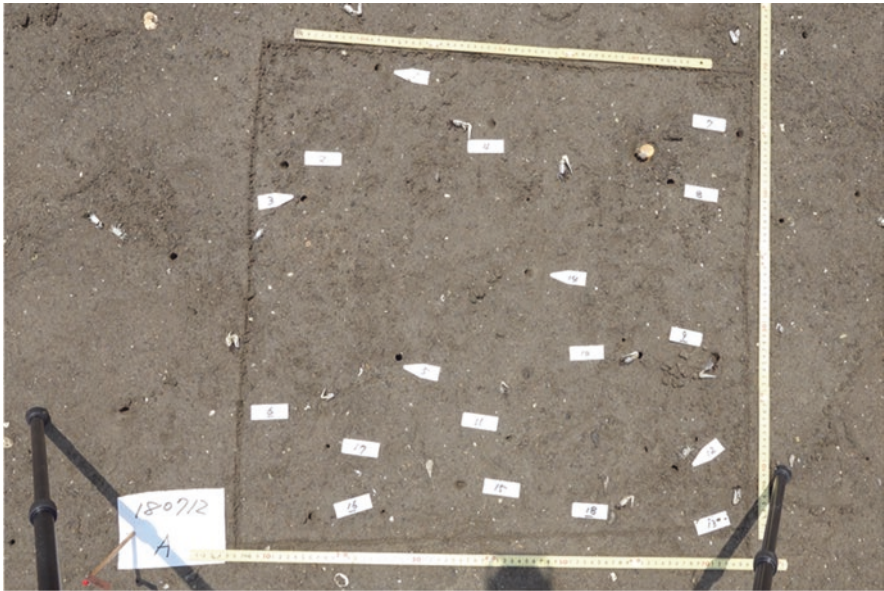
The aims of this section were to characterize reproductive and aggressive behaviors in crabs of the superfamily Ocypodoidea in the field.

1. What kind of males have high reproductive success?
2. What is the trade-off between growth and reproduction?
3. What is the function of the semidome? (see Fig. 17.14).
4. When do fights escalate?

**Fig. 17.11** Correlations between the carapace sizes of males and females within mating pairs on underground mating (red circles) or surface mating (blue circles) of *Austruca lactea*. Dash line indicates the 1:1 relationship (Y. Henmi, unpublished data)



**Fig. 17.12** Three main elements of agonistic behavior between a resident male and an intruder male of *Austruca lactea*. Percentage indicates frequency of each element (A. Shiota, unpublished data)



**Fig. 17.13** Video recording of behavior of *Austruca lactea*. Each burrow is marked with a numbered plastic label. Quadrat size is 70 cm  $\times$  70 cm. Photo by Y. Henmi

## Methods

### 1. Mating

During daytime low tides, it is not difficult to observe the surface mating behavior of some Ocypodoidea crabs (e.g., *A. lactea*, *S. globosa*) using binoculars. On the other hand, it is difficult to observe underground mating because of its low frequency. But you can easily find pairs in burrows by digging the plugged burrows during early low-tide periods, because males plug the burrow entrance with mud from within just after pair formation. Compare the body size of male and female crabs between the two mating tactics (Fig. 17.11).

### 2. Activity of crabs

Crab activity is recorded from above with a digital video camera (Fig. 17.13). In the case of *A. lactea*, it is suitable that an area of 70  $\times$  70 cm is recorded from a height of 160 cm. Before filming, each burrow is marked with a numbered plastic label and some scale items are placed in the viewing area. After filming for 5 min, the labels and scale items are removed and the main recording of 15–30 min is started. In the laboratory, the recording is viewed and the activity (waving, feeding, fighting, etc.), sex, and body size (carapace width; CW) of each crab are monitored. Sex is judged from the enlarged claw and body size is measured with a Vernier caliper on screen. Discuss the difference in the activity patterns between sex and size.



**Fig. 17.14** A male of *Austruca lactea* at the entrance of burrow covered with a semidome. Photo by Y. Henmi

### 3. Semidome construction

Male fiddler crabs often construct mud structures at the entrances to their burrows. In *A. lactea*, for example, males build low semidomes on one edge of their burrow entrance (Fig. 17.14). Clarify the function of the semidome by comparing the activity pattern of males with and without semidomes.

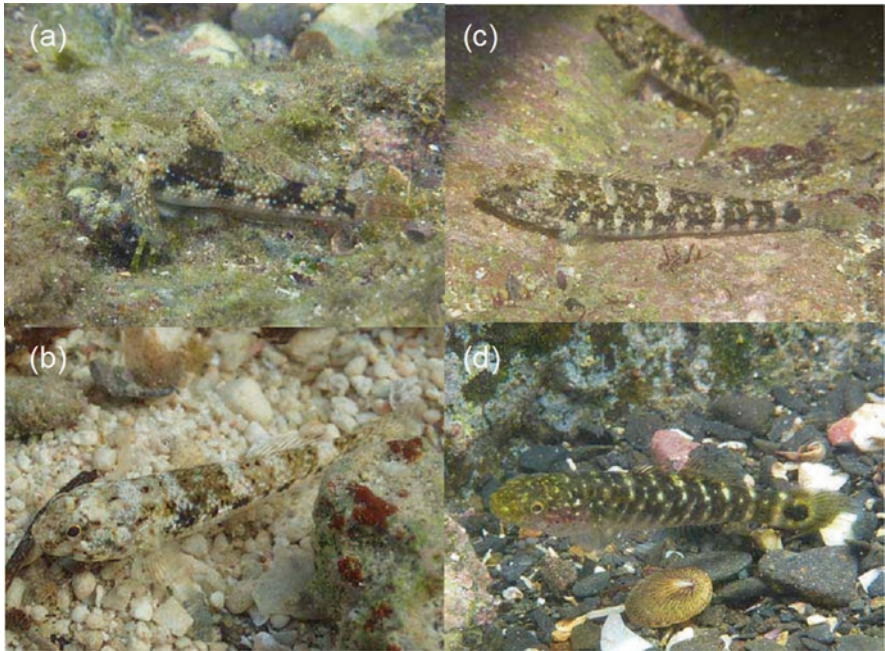
### 4. Fight escalation

In *A. lactea*, three main elements of agonistic behavior are observed in contests over a burrow between a resident male and an intruder male. Fighting escalates from Phase 1 to Phase 3 (Fig. 17.12). Phase 1 (threat): the claw is swept toward the opponent, with no contact; Phase 2 (claw pushing): opponents face each other, each opponent pushes the claw of the other with his claw. Phase 3 (claw interlacing): intercrossed claws are clamped tight, and vigorous shoving and pinching occurs. Percentages indicate the frequency of each element (Shiota, unpublished data). Follow a wandering male carefully and observe agonistic behavior against a resident male.

---

## 17.4 Habitat Selection in Tide Pool Fishes

Tide pools (tidal pools, rock pools) constitute common, important component of intertidal habitats. They can hold seawater at all times and mitigate the environmental stress on marine organisms from other intertidal habitats that are periodically exposed to the air at low-tide times. Thus, we can observe various marine organisms that are strongly associated with seawater, such as fishes. There is a distinct fish

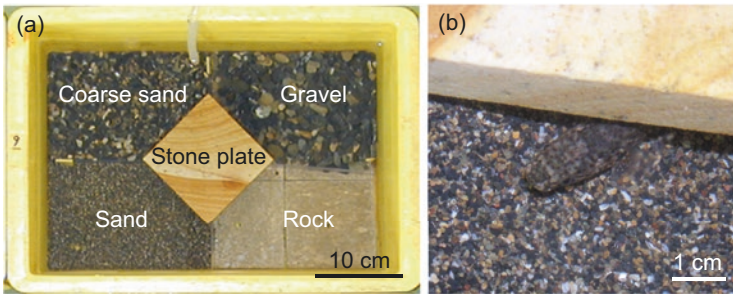


**Fig. 17.15** Common tide pool gobies with similar body sizes (35–45 mm total body length): (a) *Bathygobius fuscus*, (b) *Bathygobius cocosensis*, (c) *Chaenogobius annularis*, and (d) *Chaenogobius gulosus*. Photos by S. Arakaki

assemblage in the tide pool habitat. Gobiidae are common tide pool fishes in Japan. Some genera (e.g., *Bathygobius* and *Chaenogobius*) are dominant and can be easily found in rocky tide pools, especially in temperate-subtropical regions (Fig. 17.15).

Space is an important resource for tide pool fishes mainly due to its severe limitations at low tide. Preference for a particular habitat is closely linked to requirements for food, reproduction, avoidance of predators/competitors, and some environmental conditions. Therefore, habitat selection is an important factor that fundamentally defines the spatial distribution and organization of fish assemblages in tide pool environments.

We here show an example of a laboratory experiment to observe the patterns in microhabitat choices within a tide pool. We can also observe the variation in habitat use associated with different species, individuals, body sizes, sexes, and times of day. Additionally, based on the results of multi-individual experiments, the influence of intra-/inter-specific interactions on habitat use can be examined. In this section, however, we focus on single-individual experiments to simplify the contents. Details of multi-individual experiments can be obtained elsewhere (e.g., Arakaki and Tokeshi 2011, 2012).



**Fig. 17.16** (a) Experimental aquarium (top view) with four different substrata and a stone plate (10 × 10 cm) as shelter. Substrate types are rock (stone tile), gravel (particle diameter 5.6–19 mm), coarse sand (1–5.6 mm), and sand (0.25–1 mm). (b) *C. gulosus* under shelter (stone plate) in the sand substrata. Photos by S. Arakaki

### Objective

To examine the fundamental patterns in the microhabitat (shelter, different substratum types) preference of tide pool fishes.

### Method

Fish individuals used in the experiment are collected from the field and kept (separately, depending on species and size differences, if any) in large aquaria with a flow-through seawater system for at least few days prior to the experiment.

Observations are conducted by using aquaria (rectangular opaque plastic boxes) that imitate small natural rocky tide pool conditions at low-tide times (~1200 cm<sup>2</sup> water surface area with 5 cm water depth) with different type of substratum and/or shelter (Fig. 17.16). Each aquarium is subdivided into four equal quarters and a square stone plate (100 cm<sup>2</sup> surface area) is placed in the center to serve as a rooftop such that a fish could use the shaded space below as shelter. The four types of substrata with different particle sizes should be allocated at random to the four quarters of the aquaria.

A fish individual is chosen arbitrarily from the maintenance aquarium and introduced into the center of an experimental aquarium some time (>30 min) before the actual observation. After the acclimatization period, record the fish position at intervals of a few minutes. When the fish has changed its location at the time of observation, record the first position only. If the fish is located on the boundary of substrata, its location is determined according to where the majority of the body mass exists and/or the position of the head. Video recording can be applicable to observe consecutive movement patterns.

### Data Analysis

For testing the significance of shelter choice, the observed frequency of the shelter use of each individual is compared with theoretical expectations based on the random placement of fish on the aquarium floor. The probability ( $P_n$ ) that a fish is observed in the shelter  $n$  or more times (out of the total observation time of an experiment trial,  $N$ ) by chance alone is calculated as the following:

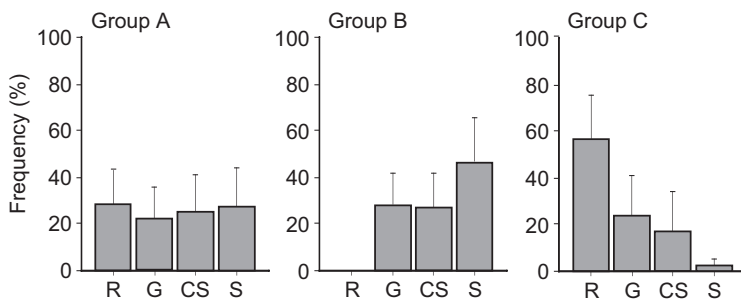
$$P_n = 1 - \sum_{i=0}^{n-1} \binom{N}{i} \left(\frac{S}{T}\right)^i \left(\frac{T-S}{T}\right)^{N-i},$$

where  $S$  and  $T$  are the shelter area and total area of the aquarium floor (all available floor space for fish, including wall parts if necessary), respectively.

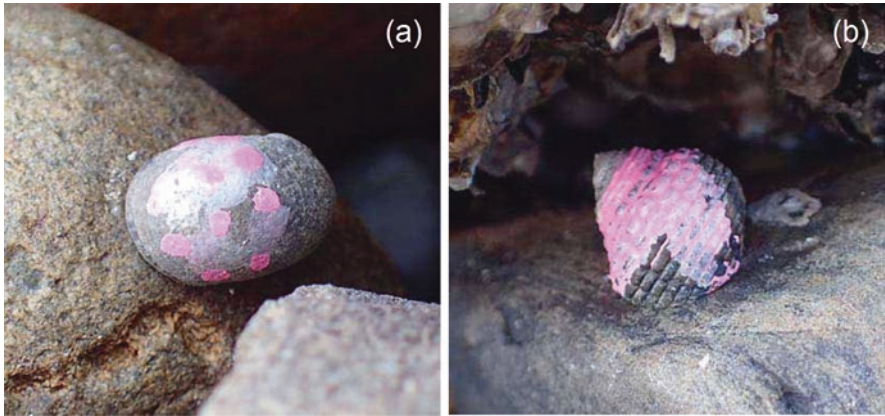
To test the substratum preference, the observed frequency is compared to the expected values of non-preference (i.e., habitat use evenly). Thus, the  $\chi^2$  test for goodness of fit is applicable. To examine significant difference between trial groups (individuals, species, size classes, etc.), the  $\chi^2$  test for independence can be employed. Imaginary results are shown in Fig. 17.17. Please refer to Arakaki and Tokeshi (2005) for details of the experiment and example of the results.

## 17.5 Movement Pattern of Intertidal Organisms

By using the mark and recapture method, we can examine the movement patterns of intertidal organisms, such as the site fidelity of tide pool fishes, homing behavior of limpets, etc. Here, we show an example of two common intertidal gastropods, *Nerita japonica* and *Monodonta labio*. Generally, *Nerita japonica* is distributed in the upper intertidal zone and moves slower than *Monodonta labio* which is more widely distributed in the intertidal.



**Fig. 17.17** Imaginary frequency of substratum use by three different groups (mean + 1 standard error). Substratum types are *R* rock, *G* gravel, *CS* coarse sand, and *S* sand. Except for group A, other two groups (B and C) show a significant departure from the equitable use of the four substrate types ( $P < 0.05$ ,  $\chi^2$  test for goodness of fit). There are significant differences in the proportional use of substratum types between each pair of groups ( $P < 0.05$ ,  $\chi^2$  test for independence)



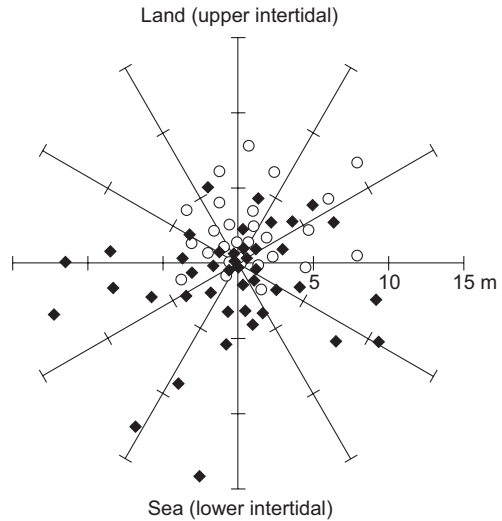
**Fig. 17.18** Marked snails, (a) *Nerita japonica* and (b) *Monodonta labio*, in the field. Photos by S. Arakaki



**Fig. 17.19** Search for marked snails and measurement of recapture position at low tide. Photo by S. Arakaki



**Fig. 17.20** Imaginary plot of recapture points for comparing movement patterns between the two common intertidal gastropods, *Nerita japonica* (open circle) and *Monodonta labio* (filled diamonds)



## Objectives

Tracking snails' movements and comparing patterns between the two species.

## Method

Each observation group collects a sufficient number of snails (>70 individuals of each species) from the field. Snails are individually marked using a marker pen (Fig. 17.18, every group should have different color) and released at the site of collection (to avoid genetic disturbance). Each group chooses and clearly marks a single release point, which can vary among groups in terms of tidal position to some extent. It is better to release when the tide is incoming in order to reduce damage from heat and desiccation. We can also conduct consecutive field observations, including at high tide time, if necessary. One day later, try to find the marked individuals for 1 h (or longer). When you find the marked individual, record the distance and direction from the release point (Fig. 17.19). It would be better to standardize search effort for all directions and distances. For data analyses, you can compare the movement distance/direction between species (Fig. 17.20).

## References

- Arakaki & Tokeshi. (2005). Microhabitat selection in intertidal gobiid fishes: Species and size-associated variation. *Marine Biology Research*, 1, 39–47.
- Arakaki & Tokeshi. (2011). Analysis of spatial niche structure in coexisting tidepool fishes: Null models based on multi-scale experiment. *Journal of Animal Ecology*, 80, 137–147.
- Arakaki & Tokeshi. (2012). Species and size matter: An experimental study of microhabitat use under the influence of competitive interactions in intertidal gobiids. *Journal of Experimental Marine Biology and Ecology*, 418–418, 59–68.
- Henmi, Y., Koga, T., & Murai, M. (1993). Mating behavior of the sand bubbler crab *Scopimera globosa*. *Journal of Crustacean Biology*, 13, 736–744.

- Kawano, Y., & Henmi, Y. (2016). Female preference for large waving claws in the dotillid crab *Ilyoplax pusilla*. *Journal of Ethology*, *34*, 255–261.
- McLaughlin, P. A., Komai, T., Lemaitre, R., & Rahayu, D. L. (2010). Annotated checklist of anuran decapod crustaceans of the world (exclusive of the Kiwaoidea and families). *Raffles Bulletin of Zoology*, *23*, 5–107.
- Mishima, S. (2010). *Life history and shell utilization patterns of the sympatric two Pagurus species (P. nigrofascia and P. minutes), especially with embryonic diapause of P. nigrofascia*. Ph.D. thesis, Kumamoto University.
- Murai, M., Goshima, S., & Henmi, Y. (1987). Analysis of the mating system of the fiddler crab, *Uca lactea*. *Animal Behaviour*, *35*, 1334–1342.

---

**Part IV**

**Marine Ecology**



Jason M. Hall-Spencer

## Abstract

Ecologists study the interactions between organisms and their physicochemical and biotic environment. This spans biochemical, cellular and individual organism processes, as well as biological community and ecosystem levels of organization. Rocky shores have long been a testing ground for ecological theory as they are easily accessible and have strong gradients in abiotic and biotic conditions. A major branch of this field is the population ecology of commercially important species. Marine ecologists also study how species interact within seascapes and how energy and matter flow through ecosystems. This introduction explains the terms used to describe the zonation of marine life and provides an overview of the approaches available to investigate the ecology of Japanese waters where there are wide seasonal changes in temperature and an exceptionally high diversity of algae, plants, and animals.

Ecologists study interactions between organisms and their surrounding environment. This includes research into physical and chemical factors that affect marine life (such as temperature and salinity) as well as biotic factors (such as the influence of predators and prey). Individual organisms are affected directly and indirectly, and so they may survive best in suboptimal physicochemical conditions if, for example, there is more food or if there are fewer competitors/parasites. Marine ecology spans biochemical, cellular and individual organism processes, as well as biological community and ecosystem levels of organization.

---

J. M. Hall-Spencer (✉)

School of Biological and Marine Sciences, University of Plymouth, Plymouth, UK

Shimoda Marine Research Center, University of Tsukuba, Shimoda, Shizuoka, Japan

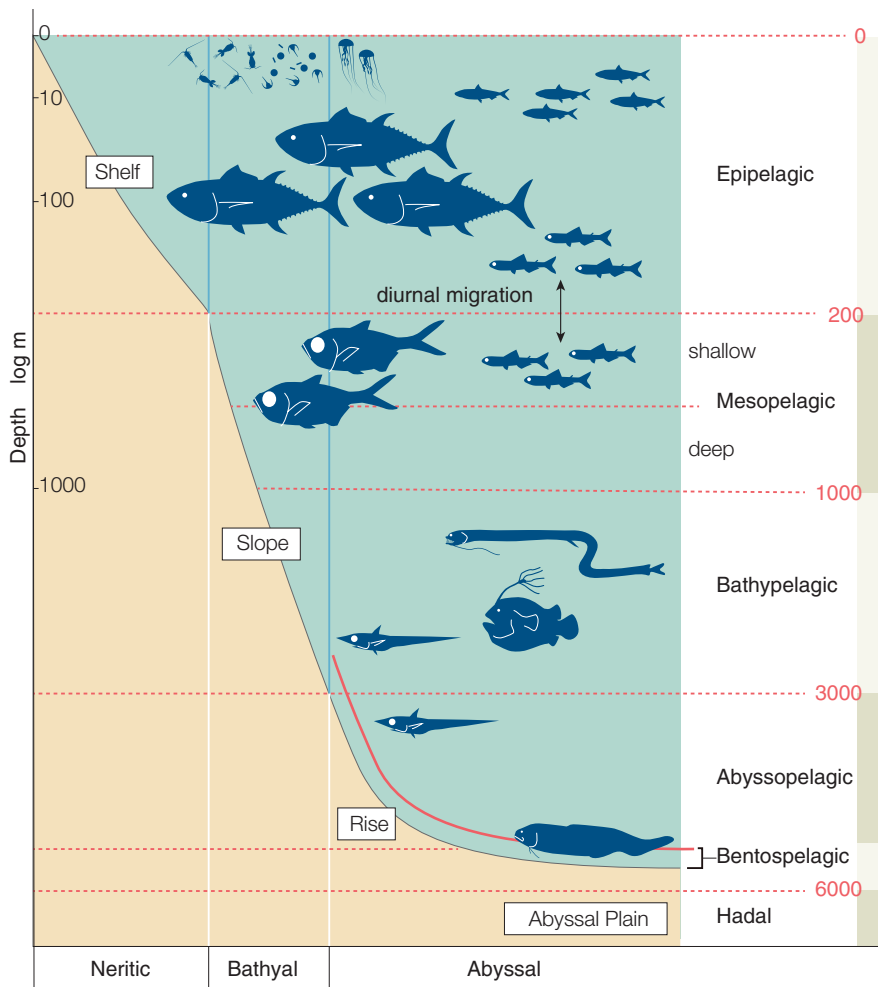
e-mail: [jhall-spencer@plymouth.ac.uk](mailto:jhall-spencer@plymouth.ac.uk)

The intertidal zone is a test bed for ecological theory since it has strong gradients in abiotic and biotic conditions. Pioneering work on the effects of disturbance and competition used manipulative experiments in intertidal systems, as did work on the roles of predation and grazing in food webs. A biologist may typically focus on individuals of one species, whereas an ecologist would more typically study how abiotic factors influence the effects of one species on other species. A major branch of marine ecology is the population ecology of commercially important species: working out how fish and shellfish interact with fishing pressure. Marine ecologists also study how species interact with a particular seascape and how energy and matter flow through ecosystems. Kaiser et al. (2020) provide a very useful standard text on marine ecology.

The coastal waters of Japan teem with life, with diverse algae, plants, and animals able to survive wide seasonal changes in temperature and light. One theory as to why Japanese species are successful in other biogeographic regions (when brought there by maritime transport or via aquaculture) is that they tolerate large abiotic variability in their native range. Marine ecosystems have biological communities of organisms that interact with one another and modify their physical environment. Kelp forests, seagrass beds, and coral reefs are examples described in more detail in this chapter. Other important ecosystems found around the coastline of Japan include salt marshes, mudflats, mangroves, estuaries, and rocky reefs. Budding marine ecologists can study this rich variety with relative ease, especially at Japanese biological stations which are equipped for this purpose.

Offshore ecosystems include the enclosed deep waters of the Sea of Japan (average depth 1752 m) where there are very small tides and the salinity and wave heights are lower than in the open ocean. Off the east coast of Japan, the warm Kuroshio current has a major influence on the distribution of marine flora and fauna. The seasonality of this region gets more pronounced with increasing latitude such that primary producers at the base of marine food chains are starved of light in winter then in spring a pulse of newly fixed carbon enters the food web. Surface water productivity is also boosted by increased nutrient levels in upwelling and frontal systems.

A notable aspect of the ecology of Japanese waters is the presence of tectonic subduction providing extremely deep-water habitats (>9 km deep) close to the mainland where the Japan Trench and Izu Ogasawara Trenches meet. Here there is a gradient of marine benthic ecosystems from Hadal, through Abyssal, Bathyal, and up onto the continental shelf sediments that are bisected by deep-water canyons that are rich in benthic marine life (Fig. 18.1). There are also marked changes in open water communities from the virtually unexplored abyssopelagic ecosystem up through the bathypelagic, mesopelagic, and epipelagic zones through which organisms take diurnal migrations as they seek to maximize their survival by obtaining food and sexual mates, but avoiding predation. Tectonic activity causes hydrothermal vents which have their own specialized associated fauna that is reliant on chemosynthesis as a source of energy. Japan is also famous for having many underwater volcanoes that form chains of seamounts that are biodiversity hotspots supporting mesopelagic fisheries.



**Fig. 18.1** Terms used to describe the zonation of marine life; the neritic zone is coastal, bathyal is the continental slope, and abyssal is >3000 m deep. 90% of marine metabolism occurs in the epipelagic zone where energy from the sun stimulates phytoplankton photosynthesis. Below that is the mesopelagic zone where there is still enough light for fish to see and these species typically migrate into shallower waters at night. Below this fish tend to be weak swimmers and there is a much lower biomass of organisms (McIntyre 2010)

Ecology can include the study of geology, including land use in the catchment areas of rivers that flow into estuaries. Marine ecology also encompasses the impacts of human activities. The greatest human footprint on the ecology of the oceans to date is fisheries; marine-capture fisheries have leveled off at a maximum of 90 million tons per year. Since around the 1950s we have fished down many marine food webs so that large predatory fish, sharks, and whales are now rare or absent in most marine systems. Some fisheries activities, such as dynamite fishing and scallop

dredging, are destructive to vulnerable marine habitats and so there are branches of marine ecology devoted to sustainable marine management to help regenerate damaged marine habitats or rebuild fisheries stocks.

Tools at the disposal of marine ecologists are rapidly evolving with cheaper and better tracking and tagging devices helping assess the movements and survival of fish and other marine vertebrate movements (including seabirds) between marine ecosystems and across ocean basins. Acoustics can be used to inform marine ecology; this is how the mass diurnal migration of zooplankton was first discovered. Sound waves travel through the water and bounce off objects then travel back to a receiver, revealing information about the shape and hardness of the objects. Japanese marine ecologists use sound to map the sea floor and to identify habitats. This information can then be used to choose locations to obtain sediments, rocks, or biological samples. Satellite observations allow assessments of global primary productivity, where hotspots of Harmful Algal Blooms occur and ecological impacts of virus attacks on plankton can also be monitored from space. Mobile phone and internet technology allow the sharing of spatial and temporal marine ecological data on an unprecedented scale with global citizen science work on topics such as the effects of marine plastics on marine wildlife, or the extent of coral bleaching during marine heat wave events. There is also more widespread use of environmental DNA to assess the distribution and abundance of organisms, from bacteria to sharks.

Marine aquaculture is currently in a phase of exponential growth, yet there is no sign that this is easing pressure on wild seafood stocks and seabed habitats. However, the three main effects of greenhouse gas emissions—ocean acidification, warming, and the spread of low oxygen areas—may outstrip even the major effects of fishing on marine life, and so this is a growing area of marine ecology. Well-known marine environmental problems, such as dealing with sewage and land reclamation around cities such as Yokohama, are combining with new challenges such as flash flooding overloading wastewater treatment systems. The proliferation of wind farms may be a very desirable outcome that helps curb CO<sub>2</sub> emissions and effectively sets aside areas of seabed that are off limits to trawls and dredges; however, this may help the spread of invasive species. Marine ecologists are also needed to assess the effects of artificial island building in the South China Sea, or the hardening of natural coastlines with concrete to defend against more frequent typhoons and sea level rise. Marine ecologists consider the interconnections, symbiotic relationships, and influence of multiple interacting factors on a particular environment. They also use historical sources to assess what marine ecosystems were like in the past since before systematic marine ecological observations began in the 1900s.

Marine ecology is a broad discipline, with scientists often called upon to help forecast the effects of changes in marine management to improve the environmental status of marine ecosystems and the social benefits to be gained. We hope this chapter encourages a wide range of people, no matter what they go on to do in their professional lives, to develop an appreciation of marine ecology through visits to the coast—where we can observe the wonderful interactions that go on each day between marine life and the environment.

---

## References

- Kaiser, M. J., Attrill, M. J., Jennings, S., Thomas, D. N., Barnes, D. K. A., Brierley, A. S., et al. (2020). *Marine Ecology: Processes, Systems, and Impacts* (p. 584). Oxford: Oxford University Press.
- McIntyre, A. D. (2010). *Life in the world's oceans, diversity, distribution and abundance* (p. 361). Hoboken, NJ: Wiley-Blackwell.





Sylvain Agostini, Ben P. Harvey, and Shigeki Wada

## Abstract

In shallow coastal waters, the types of benthic communities are the result of both environmental and biological drivers. On a global scale, climate and temperature range play an important role in determining the type of benthic communities. Generally, high latitudes and temperate zones have ecosystems dominated by macroalgae, while lower latitudes and especially subtropical and tropical areas have less macroalgae and other types of ecosystems such as coral reefs. The substratum types (soft sediments, sand, or rock) and other environmental factors, such as nutrient load, light availability, or salinity, determine the fine distribution of the different ecosystems found. Each ecosystem will be shaped by a few species, often referred to as foundation species, which will create the habitats that sustain most of the associated biota. Biological interactions, such as top-down control of algae, are also an important determinant in shaping ecosystems. In this chapter, we will introduce three different types of benthic communities: kelp forests, seagrass meadows, and coral reefs.

## 19.1 Kelp Forests

Kelp forests are typically found in high latitudes and temperate zones. They are mainly limited to areas where the summer isotherms do not exceed 20 °C, but there are many exceptions, such as the kelp beds found in mainland Japan. These benthic communities are highly productive ecosystems; they can be up to four times as productive in terms of carbon fixation as intensively farmed crops on land. This high productivity comes from the species of algae that form the basis

---

S. Agostini (✉) · B. P. Harvey · S. Wada  
Shimoda Marine Research Center, University of Tsukuba, Shimoda, Shizuoka, Japan  
e-mail: [Agostini.sylvain@shimoda.tsukuba.ac.jp](mailto:Agostini.sylvain@shimoda.tsukuba.ac.jp)

of these ecosystems: macroalgae belonging to the order Laminariales (phylum: Heterokontophyta), commonly referred to as kelp. Kelp require hard substrata to attach to and grow in the infra to sub-littoral zones at depths down to 20–50 m, depending on the clarity of the water. The exact species of kelp that are found depend on the biogeographic region. Typical examples of kelp found in the Pacific are giant kelp, *Macrocystis pyrifera*, found off the coast of California, or *Ecklonia cava*, which is found off the coast of mainland Japan. Kelp forests have an important economic value. Some species are directly edible, such as *Undaria pinnatifida*, known in Japanese as ‘Wakame’, and kelp forests sustain a rich ecosystem from which fisheries can exploit abalones, urchins, and fish. Kelp thalli typically have a holdfast that allows them to attach to rocks, a flexible stipe, and thin large blades. Some kelp species are among the fastest growing algae, with growth rates of several centimeters per day commonly observed. Giant kelp can exceed 50 m in length, and other species such as *Saccharina japonica* (‘Kombu’) often exceed 3 m in length. Kelp can be annual or perennial, with seasonal species showing the fastest growth in late winter and spring.

The biological diversity found in kelp forests is maintained by the 3D structure formed by the kelp providing spatial heterogeneity and diverse habitats. Kelp canopies host a diverse fauna and flora that use the algae for food, refuge from predators, or habitat. The blades of kelp harbor both epiphytic flora (microphytes, diatoms, etc.) and fauna (bryozoans, ascidians, etc.). Other molluscs, crustaceans, and worms, as well as a variety of algae, are often associated with kelp, whether on its blades or in its shaded understory or (especially) the spaces created by holdfasts. It is considered that most of the carbon produced by kelp does not directly enter the food chain and is either buried or exported to outside the habitat. However, the abundance of kelp can be strongly controlled by sea urchins through intense grazing. This is especially true when natural predators of sea urchins are overfished in ecosystems. A famous example is the removal of the sea otter in Alaska, which leads to an increase in the sea urchin population and subsequent decrease in kelp abundance, creating a bare ecosystem called an urchin barren. In Japan and Eastern Australia, recent increases in temperature have been limiting the abundance of kelp. The direct effect of increased temperature, but also increases in the abundance of subtropical herbivorous fishes, such as *Calotomus japonicus*, are thought to be factors leading to decreased kelp abundance, a phenomenon known in Japan as ‘isoyake’ (Figs. 19.1 and 19.2).

### 19.1.1 Example of Survey

The canopy, understory, and holdfast of kelp forests host very diverse communities of macrofauna. This fauna can be assessed using quadrats and by sampling the holdfasts. Typically, a 50 × 50 cm quadrat can be placed on the canopy. Top-shells, such as *Tegula pfeifferi*, and hydrozoans, such as *Aglaophenia whiteleggei*, can be observed and counted. The quadrat can then be moved to the understory where sponge and colonial ascidian coverage can be recorded along with the abundances of macrofauna (sea urchins, gastropods, holothurians, etc.). In addition, the biomass

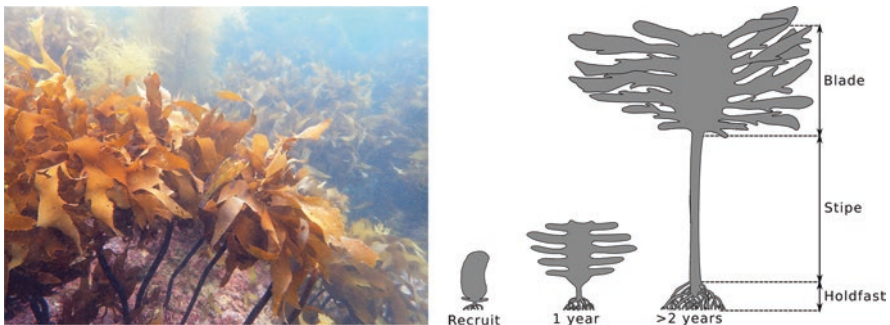
of kelp per surface area can be assessed by sampling all thalli within the quadrat. The thalli then can be dried (60 °C overnight) and their dry weight measured (Fig. 19.3).

## 19.2 Seagrass Meadows

Seagrass meadows are found worldwide, from temperate to tropical areas. The foundations of these benthic communities are angiosperms encompassing around 50 species from 12 genera, three of which comprise most of the known species: *Halophila*, *Zostera*, and *Posidonia*. They are flowering plants that produce fruits and seeds; they are rare examples of organisms with a terrestrial origin that succeed

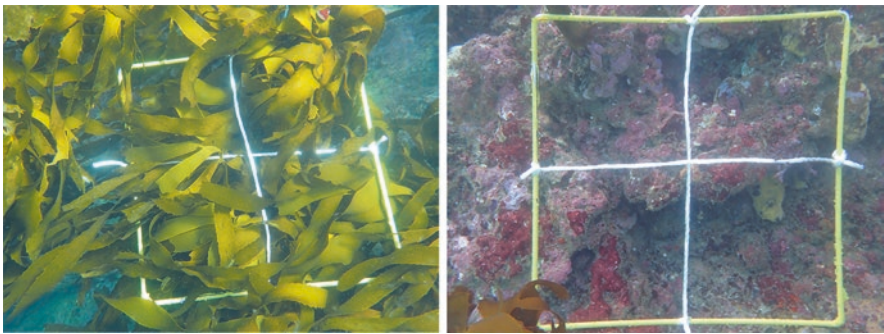


**Fig. 19.1** The approximate distribution of kelp (blue) and coral reefs (pink) in world coastal areas. Kelp is mostly restricted to temperate and arboreal areas, while shallow coral reefs are only found in warmer tropical and subtropical seas. The map is based on Steneck et al. (2002) and Teagle et al. (2017) for kelp distribution and Veron et al. (2015) and UNEP-WCMC et al. (2018) for coral reef distribution

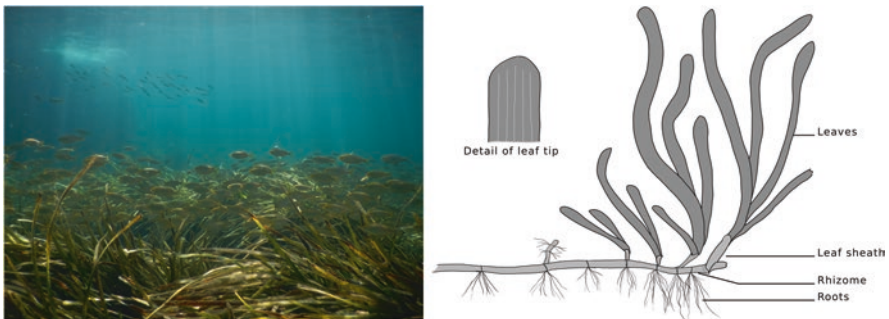


**Fig. 19.2** Left: Kelp bed of *Ecklonia cava* in Shimoda, Japan (Photo: Sylvain Agostini). Right: Schematic showing the morphology of *Ecklonia cava*

in marine environments. Seagrass meadows are often monophyletic, especially in temperate zones. The species found in these environments depend mostly on the biogeographic region. The species *Posidonia oceanica* is endemic to the Mediterranean Sea, where it occupies large areas (Fig. 19.4). *Zostera marina* is, in contrast, one of the most widespread flowering plants in the northern hemisphere, where it can be found on most coasts of the North Atlantic and North Pacific. It prefers the cooler water of temperate zones, and can survive a wide range of salinities, as is the case for many other seagrass species, which are found in estuaries. In tropical areas, meadows composed of several species of seagrasses can be observed. Seagrass beds are typically found in the shallower parts of the lagoon in coral reefs. As opposed to seaweeds such as kelps, most seagrass species colonize sedimentary areas. They anchor themselves using roots and rhizomes. Seagrasses are modular organisms with units formed by bundle of leaves and roots that repeat



**Fig. 19.3** Quadrat survey on the canopy (left) and understory communities (right) in a bed of *Ecklonia cava*, in Shimoda, Japan. The canopy shows the dense blades and the *Tegula pfeifferi* that graze on them. In the understory, the shaded environment is suitable for the growth of coralline algae, sponges, and colonial ascidians. On the top-left of the quadrat in the understory, a holdfast of a plant can be seen, completely covered by organisms (Photo: Sylvain Agostini)



**Fig. 19.4** Left: A meadow of *Posidonia oceanica* in the Mediterranean Sea, showing epibiota on the leaves and schools of fishes (Photo: Sylvain Agostini). Right: Schematic showing the morphology of *Zostera marina*

themselves along a horizontal rhizome during clonal growth (Fig. 19.4). Seagrass meadows play an important role in coastal ecosystems by stabilizing sediment and releasing of oxygen from the roots, which favors the decomposition of buried organic matter.

While seagrass meadows are often composed of one species of seagrass, diversity is found in the fauna and flora associated with them. Seagrass leaves, often long and relatively narrow and strap-like, represent an ideal support for the attachment and growth of a wide variety of epiphytes, microalgae, and macroalgae. While the main primary production in seagrass meadows is from the seagrass themselves, epiphyte production can nevertheless represent as much as 20–60% of the above-ground production in meadows. The high primary production in seagrass meadows will support a wide variety of herbivorous organisms, such as sea urchins and fish, as well as larger organisms, such as sea birds, green turtles, and dugong. The dense canopy and intricate structure of the rhizome and roots form diverse habitats suitable for numerous animal species, comprising infaunal (species that live in the sediment), epifaunal (species that live on stems and leaves), and epibenthic (species that move freely on the sediment and in the canopy) groups. All of these fauna form part of a complex food web. Some of the fauna, such as isopods and crabs, will be directly dependent on the living seagrass tissue. Other dwellers and smaller crustaceans from the epifauna, including amphipods from the Caprellidae family, will consume algal detritus or the biofilm, composed of filamentous algae and bacteria, on the surface of the leaves. Similarly, molluscs, such as top-shells, will often rely on the microalgae and detritus found on the leaves and in the sediment of the meadows. The abundant epifaunal community will be a source of food for numerous fish species that are associated, permanently or occasionally, with seagrass meadows. Seagrass meadows are also common spawning locations for fishes, with juveniles representing an important part of the fish population.

### 19.2.1 Type of Surveys

A typical survey that can be performed in seagrass meadows is the measurement of seagrass shoot density and both the aboveground and underground biomass. Typically, a 50 × 50 cm square is used, and all shoots within the quadrat are counted. For biomass measurement, the above-ground (leaves and vertical rhizome) and underground (horizontal rhizome and roots) parts of the plants are sampled. The different parts are dried overnight at 60 °C and their dry weights are measured. To assess the food web in seagrass meadows and other ecosystems, a practical way is to analyze the gut content of fishes. This information can then be linked to the epifauna observed on the leaves of the seagrass. Fishes can be sampled using hand nets, gill nets or traps. The fishes are then kept on ice until observation. Alternatively, formalin can be injected into the stomachs of the fishes to stop digestion. The gut contents are then extracted by dissection and the origins of the organisms and debris are identified. For more complex studies, stable isotopic ratios ( $^{13}\text{C}$  and  $^{15}\text{N}$ ) can

be analyzed from a set of prey and predators, allowing the reconstruction of food webs.

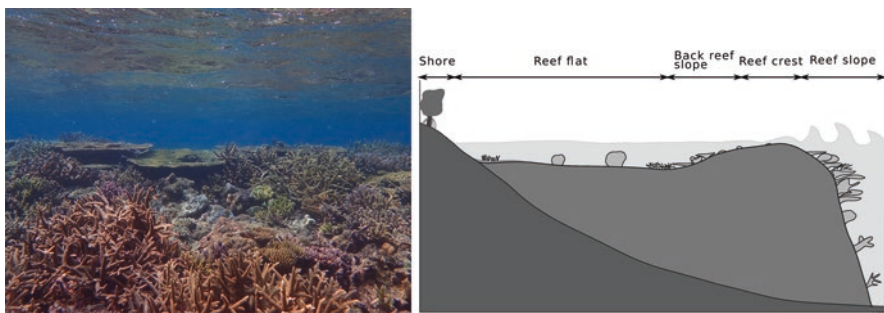
---

### 19.3 Coral Reefs

Coral reefs are geomorphological structures formed mostly by the accumulation of the calcium carbonate skeletons of hermatypic corals (phylum Cnidaria, order Scleractina). Corals can thrive in warm and clear tropical waters where they can form reefs. However, corals, individually or in small communities, can be found in higher latitudes, such as in the warm temperate areas of mainland Japan. The limit for the distribution of reefs is considered to be mainly the winter minimal temperature, as these reefs can only be found where the temperature does not fall below 18 °C. Other parameters, such as the aragonite saturation state, the saturation state of the calcium carbonate form of the coral skeleton, light penetration depth, salinity, and nutrient load, also determine the fine distribution of corals. Despite the lack of nutrients in the water associated with many coral reefs, they are some of the most productive and diverse ecosystems. An explanation for this is that many corals, the foundation of these ecosystems, live in symbiosis with microalgae, dinophytes of the family Symbiodiniaceae, often called zooxanthellae. The primary production in coral reefs is mostly due to corals zooxanthellae, and to a lesser extent, the macroalgae and phytoplankton in the water column. Estimates of 1500–5000 g C m<sup>-2</sup> y<sup>-1</sup> show that the primary production is much higher than that of the surrounding open oceans, which are usually limited in nutrients. However, the net community production is close to zero, as in reefs most of the organic matter produced is soon remineralized. First, the photosynthates produced by zooxanthellae are translocated to their host, where they are used. They represent as much as 90% of the energy requirements of the host. Some of this organic matter will also be released in the form of mucus by the corals, which will cluster, sink, and be buried in the sediment where it will be remineralized by an abundant microbial community. The macroalgae that can be found in coral reefs are under intense grazing pressure by the numerous fish inhabiting these environments. As a result, the production to respiration ratio of a reef community is often close to one.

While they represent only 0.2% of the total surface of the ocean, tropical coral reefs host almost one third of all known marine species. Warm water corals grow rapidly forming colonies with complex shapes, and thus provide numerous habitats. In the Pacific, around 600 species of hermatypic corals are known and the Great Barrier Reef hosts more than 4000 species of molluscs, 1400 species of fish, and many more macro, micro, and meiobenthos that remain mostly unknown. Many calcareous organisms such as molluscs and sea urchins, participate in the formation of reefs, with coralline algae and encrusting bryozoans consolidating the accumulated carbonate sediment in the limestone framework. Reefs offer several habitats with different environments. Coral reefs can be categorized under different morphologies: fringing reefs are attached to the edge of the islands or land masses, barrier reefs are separated from the land mass by a deep lagoon, and atolls are formed

by the subsidence of a volcanic island to below sea level where only the coral reef remains, forming a ring. Each area of the reef is associated with different coral species and associated fauna, showing a clear zonation. In the case of fringing reefs (Fig. 19.5), the ocean-facing slope goes from the surface to depths of more than 50 m. The diversity and species patterns observed in this area are higher in the shallower zones; it is mainly dictated by wave action and light availability. Large tabular coral colonies and high diversities of large corals and fishes are observed in shallower zones, with diversity decreasing in the deeper zones. Above the reef slope, the reef crest is the highest point of the reef and will mark the limit between the reef and the open ocean. The crest is exposed to strong wave action and is often exposed at low tide. Only the most robust corals can survive in this environment, and hardy low-profile corals (e.g., thick-branched pocilloporids and acroporids, and submassive *Goniastrea* species) are observed. The back reef or reef flat is sheltered from wave action, and stretches from the crest to the shore. Depths are variable depending on the size of the reef. The back reef can range from a few tens of meters to a few thousand meters in length, and from a few centimeters to several meters deep. The substratum here is variable; coral rocks, rubble, and sand form patches to which different fauna and flora are associated. In the shallower zones, close to the shore, seagrass meadows and algal beds are often present. In the deeper parts, massive *Porites* colonies can form microatolls that can grow up to the lowest water levels during low tide. Coral coverage and diversity tend to be higher near the seaward area of reefs. Because of their multiple microhabitats, these areas of the reefs support a large diversity of echinoderms, worms, and molluscs. Fish are omnipresent and diverse on coral reefs. Herbivorous fish, damselfish, parrotfish, etc. and herbivorous sea urchins, such as *Diadema* spp., intensively graze the macroalgae present. Corals, in addition to representing a perfect hiding place for many fish species, are also sources of food for corallivores such as pufferfish (Tetraodontidae), triggerfish (Balistidae), butterflyfish (Chaetodontidae), and some parrotfish (Scaridae). Predatory fishes and large sharks, which feed on the abundant fauna, are a common sight on coral reefs and a sign of a healthy ecosystem.



**Fig. 19.5** Left: Corals close to the reef crest in a reef near Sesoko Island, Okinawa, Japan (Photo: Yuko F. Kitano). Right: Schematic representing the different zones within a fringing reef

In recent years, global and local threats are contributing to the loss of coral reefs. Increased temperatures lead to a higher frequency of massive bleaching events, during which corals lose their zooxanthellae (or photosynthetic pigments). Severe bleaching events can then lead to mass mortality, as has been observed recently worldwide during 2015–2017, the third recorded global mass bleaching event. Ocean acidification is also predicted to negatively affect coral reefs by limiting the growth of corals. Terrestrial run-off, coastal construction, overfishing, and destructive fishing habits are also sources of anthropogenic disturbance (Fig. 19.6).

### 19.3.1 Example of Surveys

Shallow reef flats are easily accessible for survey by snorkeling. Transect lines can be laid, and the coral and associated fauna diversity can be investigated. In a healthy reef, where coral abundance and diversity is high, belt transects of 10 m long and 1 m wide are commonly used. For very high abundances, line intercept transects or systematic point intercept transects or quadrats may be used instead (also see section Chap. 22). Point intercept transects (50 m long with recordings every 50 cm) at two different depths are used by Reef Check worldwide. In all cases, care should be taken while surveying the reefs to not break corals while walking or with fins. Coral reefs are home to several dangerous species: moray eels, blue-ring octopuses, and stonefishes, and care should be taken. For fish surveys, underwater visual censuses, 20–50 m long, are often used, but due to the high abundance and diversity, these kinds of survey require specialist training. Coral identification is also difficult and may require sampling for identification using skeleton morphology. However, the sampling of corals is highly restricted; ensure that adequate permits are obtained.



**Fig. 19.6** Left: A diver conducting a point intercept transect in a high-latitude coral community in Shimoda, Japan. Note the use of a measure tape and a weighted line to control for parallax. The data are recorded in situ and a camera attached to the diver records the transect (Photo: Yasutaka Tsuchiya). Right: 1 × 1 m quadrat photos showing the high diversity and complexity of coral in a healthy coral reef in Sesoko Japan (Photo: Yuko F. Kitano)



## References

- Steneck, R. S., Graham, M. H., Bourque, B. J., Corbett, D., Erlandson, J. M., Estes, J. A., et al. (2002). Kelp forest ecosystems: Biodiversity, stability, resilience and future. *Environmental Conservation*, 29, 436–459. <https://doi.org/10.1017/S0376892902000322>
- Teagle, H., Hawkins, S. J., Moore, P. J., & Smale, D. A. (2017). The role of kelp species as biogenic habitat formers in coastal marine ecosystems. *Journal of Experimental Marine Biology and Ecology*, 492, 81–98. <https://doi.org/10.1016/j.jembe.2017.01.017>
- UNEP-WCMC, WorldFish Centre, WRI, TNC. (2018). *Global distribution of warm-water coral reefs, compiled from multiple sources including the Millennium Coral Reef Mapping Project* (Version 4.0. Includes contributions from IMaRS-USF and IRD (2005), IMaRS-USF (2005) and Spalding et al. (2001)). Cambridge: UN Environment World Conservation Monitoring Centre.
- Veron, J., Stafford-Smith, M., DeVantier, L., & Turak, E. (2015). Overview of distribution patterns of zooxanthellate Scleractinia. *Frontiers in Marine Science*, 1, 81. <https://doi.org/10.3389/fmars.2014.00081>



Koetsu Kon, Motohiro Shimanaga,  
and Masahiro Horinouchi

## Abstract

Intertidal/littoral zones are the areas closest to the coast in marine ecosystems. They include a variety of habitats, such as rocky shores, sandy beaches, soft sediments, salt marshes, and mangroves. The intertidal zone, which is located between the extreme low water of spring tide (ELWS) and the extreme high water of spring tide (EHWS) lines, is exposed to the air at low tide and is underwater at high tide. Accordingly, the organisms that inhabit this zone have adapted to extremely harsh environments. Water is available regularly with the tides but varies from fresh to highly saline. The temperature also fluctuates from quite hot during a summer day to near freezing in colder climates during low tide when the area is exposed to air. Such environmental gradients cause apparent zonation, which creates a vertical distribution pattern of organisms.

## 20.1 Rocky Shore

Rocky shores are situated on coastal areas exposed to waves, and are predominantly comprised of solid rock (Fig. 20.1). In this region, epibenthic organisms are dominant on rock surfaces, whereas infaunal species are not very abundant due to the difficulty of inhabiting solid rock. Rocky shore communities, particularly

---

K. Kon (✉)

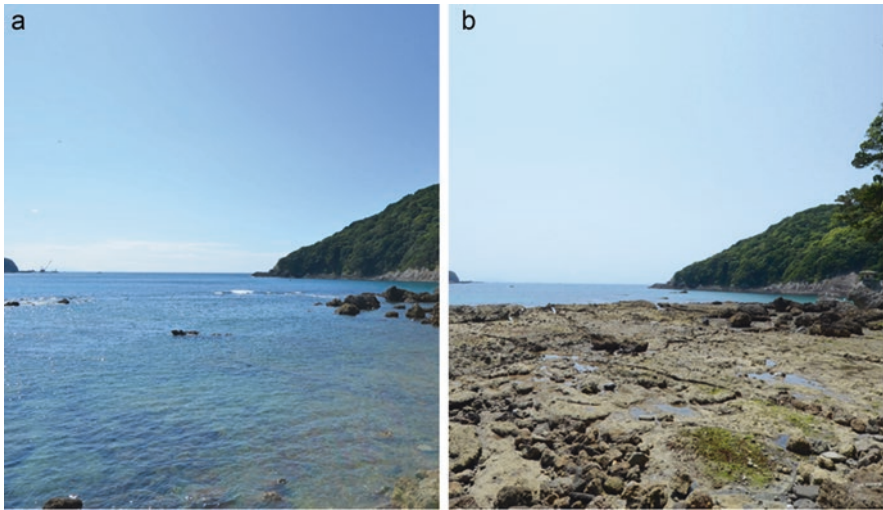
Shimoda Marine Research Center, University of Tsukuba, Shimoda, Shizuoka, Japan  
e-mail: [kon@shimoda.tsukuba.ac.jp](mailto:kon@shimoda.tsukuba.ac.jp)

M. Shimanaga

Center for Water Cycle Marine Environment and Disaster Management, Kumamoto University, Kumamoto, Japan

M. Horinouchi

Aquatic Ecology Division, Estuary Research Center, Shimane University, Matsue, Japan



**Fig. 20.1** An intertidal rocky shore at Oura Bay, Shimoda, Shizuoka, Japan. (a) high and (b) low tide

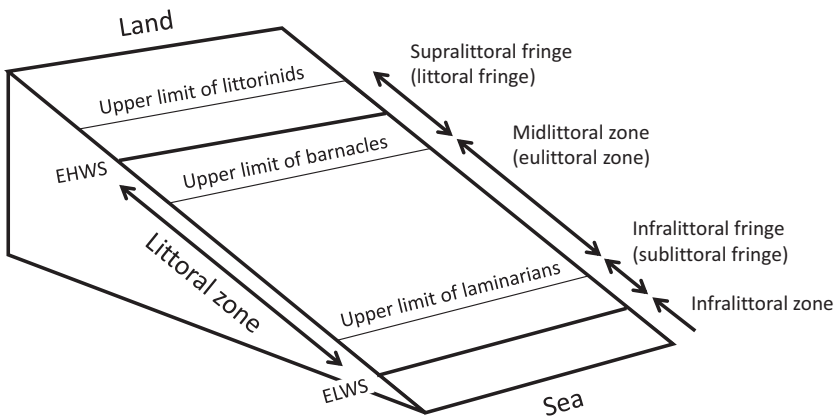
algae and sessile organisms, generally show clear zonation patterns (Fig. 20.2). Such zonation has long been studied, and a universal classification scheme of zonation has been proposed for all rocky shores (Rafaelii and Hawkins 1999; Fig. 20.3), in which the shore is divided into three major zones: a high-shore zone, called the supralittoral fringe; a broad mid-shore area, called the midlittoral zone; and a low-shore zone, referred to as the infralittoral fringe. The supralittoral fringe supports very few species and littorinid gastropods are abundant, the midlittoral zone has abundant suspension-feeding barnacles in its upper section and a mix of barnacles and macroalgae in its lower section, and the infralittoral fringe is characterized by dense macrophytes, such as brown and red algae, with a high species diversity.

As almost all of the seaweeds and animals inhabiting rocky shores have marine ancestors, they require some degree of submergence. Therefore, species at different tidal levels have different methods of survival when exposed to air. While species at high-shore levels have evolved appropriate morphologies, physiologies, and behaviors to survive for long periods without immersion, low-shore species can only cope with short periods of exposure to air. Consequently, the upper limits of organisms' distributions are normally regulated by adaptations against physicochemical factors, such as desiccation or thermal stress. However, the lower shore is within the physiological limits of more species; thus, species interactions, including competition and predation, can be factors of organisms' lower limits of distribution.

On rocky shores, habitat space is usually limited to relatively two-dimensional rock surfaces. As a result, competition for space is higher here than in other intertidal regions. Rock surfaces are sometimes occupied by sessile species colonies, indicating competitive exclusion. Meanwhile, keystone predation can maintain species coexistence by ensuring lower abundances of competitive species (Paine 1969).



**Fig. 20.2** Zonation pattern of an intertidal rocky shore at Oura Bay, Izu Peninsula, Japan



**Fig. 20.3** Stephenson and Stephenson's universal zonation scheme. Drawn by the authors based on figures in Raffaelli and Hawkins (1999)

Abundant sessile organisms (e.g., mussels, oysters, and barnacles) also function as foundation species (sensu Dayton 1972). The mussel beds or oyster reefs have complex interstitial spaces within shells, which provide habitat spaces for smaller cryptic organisms (Fig. 20.4).

## 20.2 Sandy Beach

Sandy beaches are coastal shorelines where sand, which is a sediment made from low particles (diameters between 62.5  $\mu\text{m}$  and 2 mm), accumulates (Fig. 20.5). Beaches support relatively small abundances of macroorganisms, whereas microorganisms are abundantly found in pore spaces within the sediment. Most organisms are hidden inside the sediment. Accordingly, zonation patterns are not very clear compared to those of rocky shores, which have limited habitat space on the two-dimensional surface rock. Nevertheless, some zonation schemes have been proposed. Dahl's scheme recognizes three zones based on faunal distributions: a supralittoral fringe populated by talitrid amphipods, a mid-shore area characterized by cirrolanid isopods, and a low-shore zone inhabited by Haustoriidae and Oedicerotidae amphipods (Dahl 1952). Alternatively, Salvat's scheme, based on hydrodynamics, is divided into four zones: a dry zone at the top of the beach characterized by dry sand; a zone of retention, which is the second highest zone and is damp at low tide; a zone of resurgence, which has interstitial water flowing in and out of the sediment with the tide; and a zone of saturation, which is the lowest zone and is permanently saturated (Salvat 1964).

The degree of wave exposure can also be an important factor that controls distribution (Fig. 20.6). Generally, species richness and abundance, and the biomass of



**Fig. 20.4** Mussel beds provide habitat for other organisms. Photo taken at Usujiri, Hokkaido, Japan



**Fig. 20.5** A sandy beach at Yumigahama, Izu Peninsula, Japan



**Fig. 20.6** Wave disturbance influences faunal distribution on sandy beaches

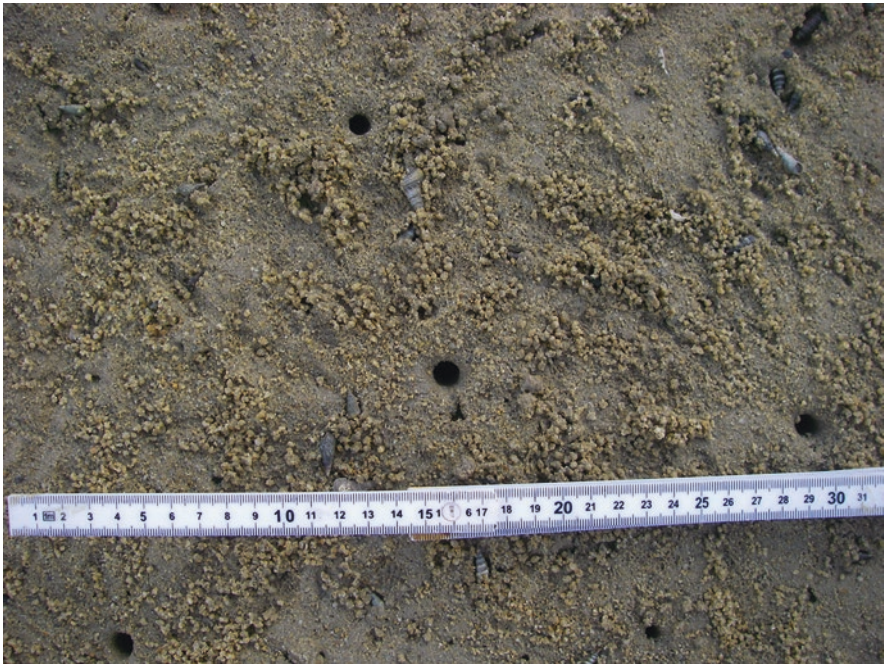
macrofaunal communities increases along the gradient of sheltered shores, because most species are unable to survive in habitats made highly unstable by wave disturbance. The organisms that inhabit exposed shores, therefore, have evolved morphologies and behaviors adapted to wave turbulence. Some species, including *Donax* bivalves, amphipods, and polychaetes, cope with turbulent conditions by burrowing very rapidly when dislodged by the surf (Branch and Branch 1981).

Furthermore, *Donax* bivalves exploit the exposed conditions by surfing up and down the shore with the tide to feed. Polychaetes withstand dislodgement by burrowing deep into the sediment or by coiling their body into an anchor shape (Tamaki 1987).

### 20.3 Mud Flat

Intertidal/littoral zones differ in the size of their substrate particles, from rocky shores to the benthic seafloor covered with soft sediments. The average size of sediment particles in a certain habitat partly reflects its exposure to water movement due to wave action. Thus, fine sediments only accumulate under sheltered conditions. On sandy beaches, the particle sizes are several hundred micrometers, and only a few micrometers on muddy tidal flats. In such environments, benthic animals can live not only on sediment surfaces, but also in the sediment layers (Rafaelii and Hawkins 1999).

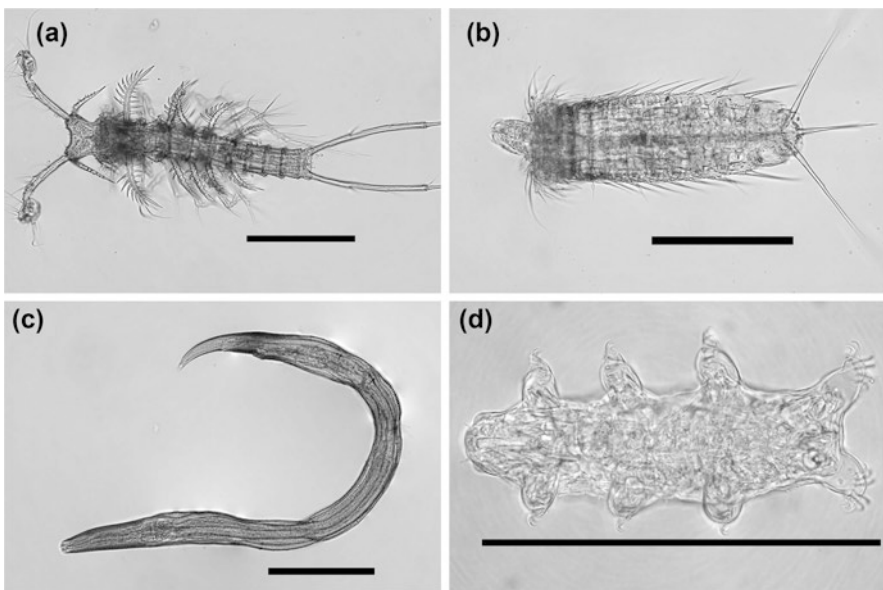
In tidal flat sediments, larger benthic invertebrates (mega- or macrofauna) construct numerous burrows (Fig. 20.7), which can function as traps for organic matter and oxidize the sediments of burrow walls. These burrows often modify the sedimentary environment in such a way that some smaller organisms become more abundant. A process between species that benefits a recipient species without



**Fig. 20.7** Burrows of ocyroid crabs on the sediment surface. Photo taken at Ariake Bay, Kumamoto, Japan

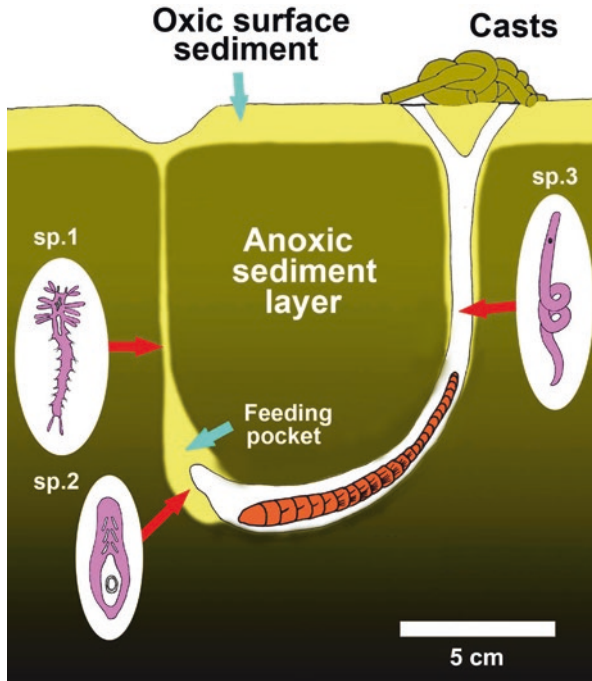
harming the donor species can be considered a ‘promotion’ of the recipient (Reise 1985).

In the sediment layer, minute invertebrates with microscopic sizes, including ‘meiofauna’, also live. Meiofauna are as an assemblage of benthic invertebrates such as nematodes, harpacticoids, and kinorhynchs (Fig. 20.8), whose size boundaries are based on the standardized mesh width of sieves with 500–1000  $\mu\text{m}$  as the upper limit and 31–63  $\mu\text{m}$  as the lower limit (Giere 2009). Usually, meiofauna exceeds macrofauna in terms of abundance; millions of meiofauna can live in 1  $\text{m}^2$  of sediment. Macrofauna, however, have important roles in their ecosystem; some macrofaunal species have promotive effects on meiofauna (Ólafsson 2003). For example, the polychaete species *Arenicola marina* (lugworm) makes U-shaped burrows in the sediment. While meiofauna generally populate only the upper few centimeters of the sediment of tidal flats because of the anoxic conditions, the oxic burrow walls of the lugworms attract meiofauna. Furthermore, the worm burrows provide various small (milli- to centimeter scale) habitats for different meiofaunal species. Some meiofaunal species occupy the head shaft or tail shaft of the burrow, whereas others prefer the feeding pocket, where the lugworm takes up particles selectively within the burrow. Consequently, these unique burrow microhabitats can help to maintain the total abundance and species diversity of meiofauna in tidal flats (Fig. 20.9; Reise 1985).



**Fig. 20.8** Meiofaunal taxa collected on a sandy shore in Japan (a) harpacticoids, (b) kinorhynchs, (c) nematodes, (d) tardigrades. Scale bar = 200  $\mu\text{m}$





**Fig. 20.9** A lugworm in its burrow and different meiofaunal species living in different microhabitats around the burrow. Drawn by the authors based on figures in Reise (1985)

## 20.4 Salt Marsh

A salt marsh is one of the coastal ecosystems in the mid-high latitudes, which being comparable to the mangrove ecosystem in (sub) tropical regions. This ecosystem is situated in the intertidal zones, thus influenced by fluctuating sea/brackish water tidal level, and is characterized by dense colonies of salt-tolerant plants including grasses, herbs, or shrubs. Such vegetation provides several beneficial ecological functions. For example, the salt marsh serves as a ‘coastal filter’, because its vegetation, especially fast-growing plants, derives a quantity of nutrients from the water flowing through the marsh, contributing to prevent eutrophication of water bodies in the adjoining and sometimes also offshore areas. Rigid root/rhizome-structures of the vegetation in the sediment, in conjunction with the wave-attenuation effect provided by the complex structure of its submerged portion, stabilize the sediment, reducing coastal erosion.

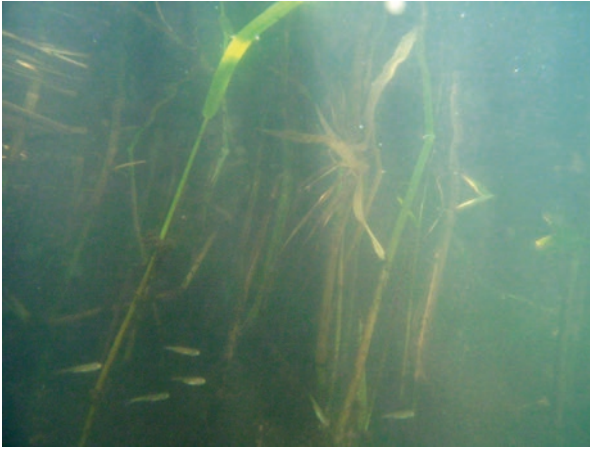
In a temperate region in Japan, salt marshes of *Phragmites australis* reed colonies are commonly found at rivermouths or brackish water lakes (Fig. 20.10). To date, however, the roles of such salt marshes with reed for aquatic organisms have rarely been examined in Japan. Nonetheless, based on studies in other areas (see



**Fig. 20.10** A salt marsh comprised mainly of common reed (*Phragmites australis*) colonies in Lake Shinji, Shimane Prefecture, Japan

review by Cattrijsse and Hampel 2006) and also few studies in Japan (e.g., Horinouchi et al. 2008; Kaneko et al. 2019), such salt marshes provide important ecological functions for the aquatic organisms. Complex structure of submerged portions of vegetation attenuates water movement and thus organic matter from other systems and the marsh itself is trapped and accumulated in the system. A large surface area harbors a large amount of epiphytic microorganisms (e.g., microalgae). Abundant organic matter and microorganisms support primary consumers such as gammaridean amphipods and polychaetes, and the latter in turn are eaten by fish and also larger macroinvertebrates and thus the salt marsh serves as an important foraging area for these consumers. The vegetation potentially reduces predation risk for juvenile fish because its complex structure obstructs a view and movements of predators with relatively large body sizes when they seek, pursue, or dart at their prey (Fig. 20.11). Small animals can experience other benefits afforded by vegetation, such as hiding behind stems/leaves or foliage, mimicking them, and being indiscernible from the background due to cryptic body coloration. Therefore, such salt marshes in Japan are thought to support diverse fish/macroinvertebrates, and serve as important nurseries for juveniles of some species including fisheries-target ones.

Salt marshes are sometimes contain microhabitats such as sparse-vegetation areas, shallow water pools which occur during low tide, and creeks. Several properties including inundation span/frequency, freshwater input, or water exchange rate also sometimes differ within a salt marsh, resulting in gradient in environmental factors such as water/soil salinity and oxygen across its upper area through marsh edge. Zonation of fauna and flora according to such differences in physical/chemical factors among microhabitats/areas occur within salt marshes. For example, shallow water in the uppermost part of the creek within the salt marsh sometimes has lower accessibility/DO/salinity because of its relative position, lower water exchange rate, and less



**Fig. 20.11** Submerged portions of common reed colonies in Lake Shinji, Shimane Prefecture, Japan

sea/brackish water input, and thus restricts residents to ones with tolerance to such severe environment, which establishing unique organism assemblage there. On the contrary, deeper water in middle-lower parts of the creek and also at the marsh edge, where inundation span is longer and water exchange rate is higher, has relatively higher accessibility/DO/salinity, allowing a variety of organisms including ones from offshore areas migrating into the system along with the upcoming tide. Such zonation of fauna contributes to high overall biodiversity of the salt marsh system.

Terrestrial animals such as birds, reptiles, and mammals, in addition to aquatic organisms, often utilize salt marshes (Fig. 20.12). For example, they forage over salt marshes during low tide, targeting aquatic animals stranded on emerged surfaces or in temporal shallow water pools and semi-aquatic animals in the sediment. Emerged portions of vegetation sometimes serve as nesting and/or foraging areas for some terrestrial animals such as birds and snakes. The salt marsh is a complex ecosystem with both aquatic and terrestrial components, harboring a wide variety of organisms and thus contributing largely to higher overall coastal biodiversity.

---

## 20.5 Mangrove Forest

Mangroves are salinity tolerant woody plants, widely distributed throughout marine and brackish coasts in tropical and subtropical zones. Around the globe, some 54–74 species and hybrids within 16–20 families are considered to be true mangrove species. The mangrove forests of Japan are the most northerly in the Indo-West Pacific biogeographical region, and comprise 14 mangrove species, including introduced species. The most northerly natural mangrove vegetation is located at Tanegashima,



**Fig. 20.12** The snake *Elaphe climacophora* lurking in a common reed colony in Lake Shinji, Shimane Prefecture, Japan



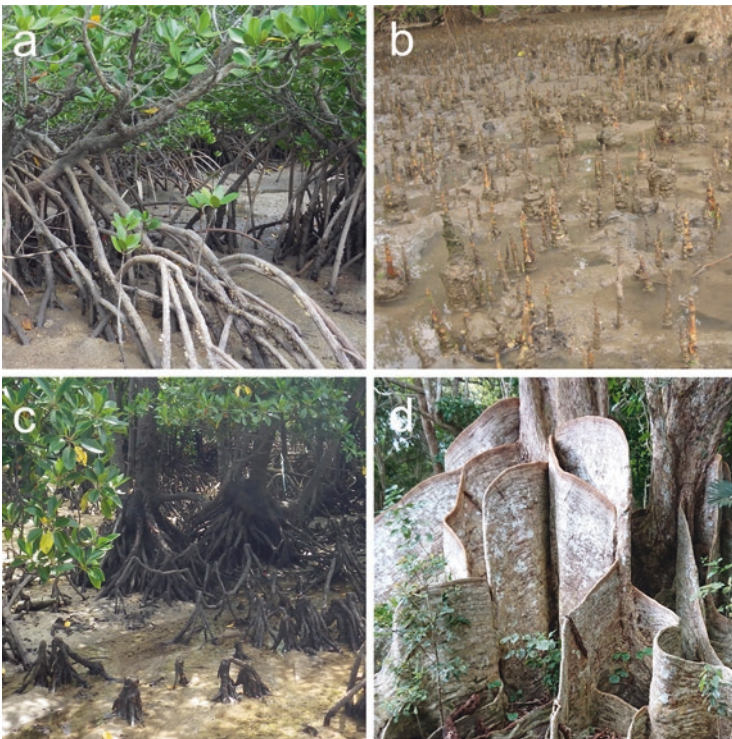
**Fig. 20.13** A mangrove forest in Funaura Bay, Iriomote Island, Okinawa, Japan

Kagoshima Prefecture. The largest mangrove forests are found on Iriomote Island, Okinawa Prefecture (Fig. 20.13).

Mangroves have morphological and physiological adaptations, as well as reproductive strategies, to survive their harsh physicochemical environments in which the soil is regularly flooded and salinity is variable. Typically, mangrove species either have tolerance or exclusion systems against salt; some species exclude salt from their xylem by physical filtration at the endodermis of the roots, while others secrete salt from their leaves through salt glands. Oxygen transportation to the roots also has characteristic adaptations, namely the development of aerating roots (Fig. 20.14). Typified by the genus *Rhizophora*, stilt roots are looping branch-like supports that

grow out from the main trunk. Pneumatophores are upward pencil-like extrusions from the sub-surface root into the air above, which have evolved in the genera *Avicennia* and *Sonneratia*. Knee roots are also upward extensions with a knee-like shape, extending from the sub-surface roots. This trait is typified by the genera *Bruguiera* and *Ceriops*. Illustrated by the genus *Heritiera*, buttress roots are extrusions of the trunk into plank-like forms extending above the soil.

Mangroves provide habitats for various aquatic organisms. The associated animals benefit from mangroves through increased food availability, shelter from predators, physical defense from harsh environments, and provision of habitat substrata (e.g., Nagelkerken et al. 2008). Large amounts of organic matter produced by mangrove detritus form the base of the ecosystem's food web (Camilleri 1992), and there are considerable contributions to secondary production by planktonic and benthic microalgae (e.g., Bouillon et al. 2002). Ecosystem engineering by mangroves is another important driver that structures faunal communities (Kon et al. 2010). The structural complexity of mangrove pneumatophores and/or stilt roots provides shelter from predators for many aquatic species (e.g., Primavera 1997). Furthermore, the distributions of some crab species are affected by the shade produced by mangrove canopies, which creates a stable physical environment within which temperature



**Fig. 20.14** Aerating roots of mangroves at Iriomote Island, Okinawa, Japan: (a) Stilt roots (*Rhizophora*), (b) pneumatophores (*Sonneratia*), (c) knee roots (*Bruguiera*), and (d) buttress roots (*Heritiera*)



**Fig. 20.15** Mangrove roots provide attachment substrate for sessile organisms. Photo taken at Sikao, Trang, Thailand

fluctuations are moderated and the sediment moisture content is high (Nobbs 2003). Mangrove stilt roots provide otherwise scarce hard substratum for benthic animals in soft-bottomed mangrove habitats. Such hard surfaces are used by tree-climbing crabs (Ellison and Farnsworth 1992) and are attachment sites for sessile organisms (Fig. 20.15). They are also used by animals that inhabit burrows in the mud.

## References

- Bouillon, S., Koedam, N., Raman, A. V., & Dehairs, F. (2002). Primary producers sustaining macro-invertebrate communities in intertidal mangrove forests. *Oecologia*, 130(3), 441–448.
- Branch, M., & Branch, G. M. (1981). *The living shores of southern Africa*. Cape Town: C. Struik.
- Camilleri, J. C. (1992). Leaf-litter processing by invertebrates in a mangrove forest in Queensland. *Marine Biology*, 114(1), 139–145.
- Cattrijsse, A., & Hampel, H. (2006). European intertidal marshes: A review of their habitat functioning and value for aquatic organisms. *Marine Ecology Progress Series*, 324, 293–307.
- Dahl, E. (1952). Some aspects of the ecology and zonation of the fauna on sandy beaches. *Oikos*, 4(1), 1–27.
- Dayton, P. K. (1972). Toward an understanding of community resilience and the potential effects of enrichment to the benthos at McMurdo Sound, Antarctica. In B. C. Parker (Ed.), *Proceedings of the colloquium on conservation problems in Antarctica*. Kansas: Allen.
- Ellison, A. M., & Farnsworth, E. J. (1992). The ecology of Belizean mangrove-root fouling communities: Patterns of epibiont distribution and abundance, and effects on root growth. *Hydrobiologia*, 247(1–3), 87–98.
- Giere, O. (2009). *Meiobenthology* (2nd ed.). Berlin: Springer.
- Horinouchi, M., Kume, G., Yamaguchi, A., Toda, K., & Kurata, K. (2008). Food habits of small fishes in a common reed *Phragmites australis* belt in Lake Shinji, Shimane, Japan. *Ichthyological Research*, 55(3), 207–217.
- Kaneko, S., Kanou, K., & Sano, M. (2019). Comparison of fish assemblage structures among microhabitats in a salt marsh in Lake Hinuma, eastern Japan. *Fisheries Science*, 85(1), 113–125.
- Kon, K., Kurokura, H., & Tongnunui, P. (2010). Effects of the physical structure of mangrove vegetation on a benthic faunal community. *Journal of Experimental Marine Biology and Ecology*, 383(2), 171–180.

- Nagelkerken, I., Blaber, S. J. M., Bouillon, S., Green, P., Haywoodf, M., Kirton, L. G., et al. (2008). The habitat function of mangroves for terrestrial and marine fauna: A review. *Aquatic Botany*, 89(2), 155–185.
- Nobbs, M. (2003). Effects of vegetation differ among three species of fiddler crabs (*Uca* spp.). *Journal of Experimental Marine Biology and Ecology*, 284(1–2), 41–50.
- Ólafsson, E. (2003). Do macrofauna structure meiofauna assemblages in marine soft-bottoms? A review of experimental studies. *Vie et Milieu*, 53(4), 249–265.
- Paine, R. T. (1969). A note on trophic complexity and community stability. *American Naturalist*, 103(929), 91–93.
- Primavera, J. H. (1997). Fish predation on mangrove-associated penaeids: The role of structures and substrate. *Journal of Experimental Marine Biology and Ecology*, 215(2), 205–216.
- Rafaelii, D., & Hawkins, S. (1999). *Intertidal ecology* (2nd ed.). London: Kluwer.
- Reise, K. (1985). *Tidal flat ecology*. Berlin: Springer.
- Salvat, B. (1964). Les conditions hydrodynamiques interstitielles des sediments meubles intertidaux et la répartition verticale de la faune endogée. *Cahiers Recherche Academie Science Paris*, 259, 1576–1579.
- Tamaki, A. (1987). Comparison of resistivity to transport by wave action in several polychaete species on an intertidal sand flat. *Marine Ecology Progress Series*, 37, 181–189.



# Marine Ecology: Continental Shelf to Deep Sea

# 21

Yoshihiro Fujiwara and Koetsu Kon

## Abstract

Continental shelves are areas of shallow water (depth <200 m) that fringe continents. Their width varies considerably (averaging 80 km); some areas (e.g., the coast of Chile) have virtually no shelf, while shelves in other areas cover several hundred kilometers (e.g., the Arctic Ocean). Continental shelves can have high primary production due to the availability of adequate sunlight (owing to these areas being in the euphotic zone), allowing abundant and diverse higher trophic level organisms to inhabit these areas. The deep sea consists of the water column below a depth of 200 m and the seafloor. It accounts for 95% of the total volume of the ocean, which is the largest habitat for life on the Earth, and is mostly unexplored. Its physicochemical environments are quite different from those in shallow-water environments, such as relatively low temperature, high hydrostatic pressure, and darkness. These environmental parameters, together with limited food availability, influence the morphology, behavior, and ecology of deep-sea creatures. Methods used for understanding deep-sea life are shown here.

## 21.1 Sea Shelf

Continental shelf is situated in the shallower parts of marine habitats. The physicochemical factors affecting the shelf therefore vary depending on atmospheric and coastal environments; the water temperature differs with climatic zone and/or

Y. Fujiwara (✉)

Japan Agency for Marine-Earth Science and Technology (JAMSTEC), Yokosuka, Japan  
e-mail: [fujiwara@jamstec.go.jp](mailto:fujiwara@jamstec.go.jp)

K. Kon

Shimoda Marine Research Center, University of Tsukuba, Shimoda, Shizuoka, Japan



season; salinity decreases with freshwater input from rivers (as seen in estuaries), and light intensity is reduced by high turbidity owing to sediment discharge from beaches and rivers. Most shelf areas are covered by terrigenous sediments; however, shallower areas can be composed of various substrata (e.g., boulders, cobbles, sand, or silt/clay).

The continental shelf is associated with high biodiversity and biological production; this phenomenon is attributable to high primary production owing to the availability of sunlight in these areas. The distribution of organisms has a vertical patterns in accordance with the temperature stability and light availability in shallower subtidal areas, although these patterns are not as clear as those in the intertidal zone (which exhibit zonation). The distribution also varies by the type of sediment; organisms are distributed above and below sediment three-dimensionally, while rocky hard-bottomed areas have a more two-dimensional distribution, where epifauna inhabit the rock surfaces. Shallower habitats are sometimes occupied by ecosystem engineers or foundation species. They create biogenic habitats, such as seagrass meadows, kelp forests, and coral reefs (see Chap. 20 for more details). Such organisms usually provide an attachment surface for smaller sessile organisms, such as epiphytic diatoms, polyzoans, hydrozoans, and colonial ascidians. Larger mobile fauna, including gastropods, crustaceans, and fish, also utilize the organisms as a habitat; a complex three-dimensional environment of biogenic habitats often functions as a refuge site from predators. Furthermore, such habitats can act as feeding grounds for herbivorous gastropods, echinoids, and fish. Accordingly, biogenic habitats support various associated organisms, exhibiting high levels of biodiversity and biological production.

---

## 21.2 Deep Sea

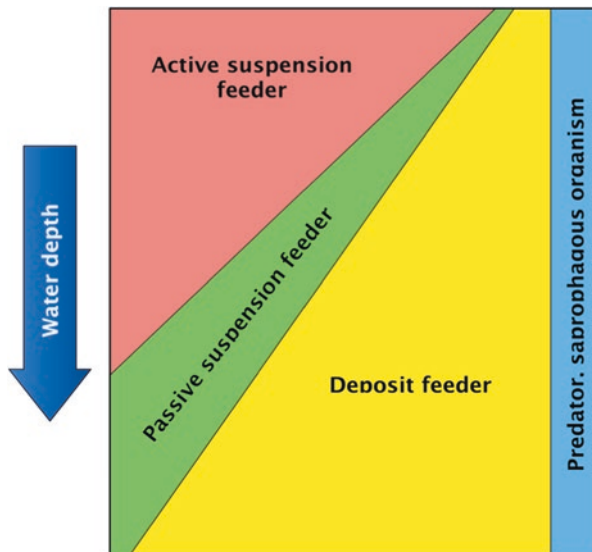
### Deep-Sea Environments

The deep sea has characteristic features that differ from the environments that we are familiar with. Its environmental variations are much less than those in shallow-water and terrestrial environments (Gage and Tyler 1991). The *water temperature* is mostly constant and relatively low (<3 °C below a depth of 1000 m). The coldest deep ocean water (about -2 °C) flows around Antarctica. In contrast, the temperature of hydrothermal emissions from hydrothermal vents is extremely high, and exceeds 400 °C at the deepest recorded hydrothermal vents found at the Mid-Cayman Spreading Center (Connelly et al. 2012). The *salinity* is relatively constant (~35‰). The *oxygen concentration* is near saturation except in the oxygen minimum layer, found at 500–600 m depth in the open ocean. The *hydrostatic pressure* increases with depth, by 1 atm for each 10 m of water depth. Low temperature and high pressure affect the rates of enzymatic catalysis (Herring 2002). *Sunlight* becomes attenuated and monochromatic down to 1000 m. Below 1000 m depth, there is no sunlight, and the only light is from bioluminescence produced by organisms. There is *no primary production* dependent on sunlight in the deep sea, but the diets of most deep-sea creatures originate from photosynthesis at the surface layers.

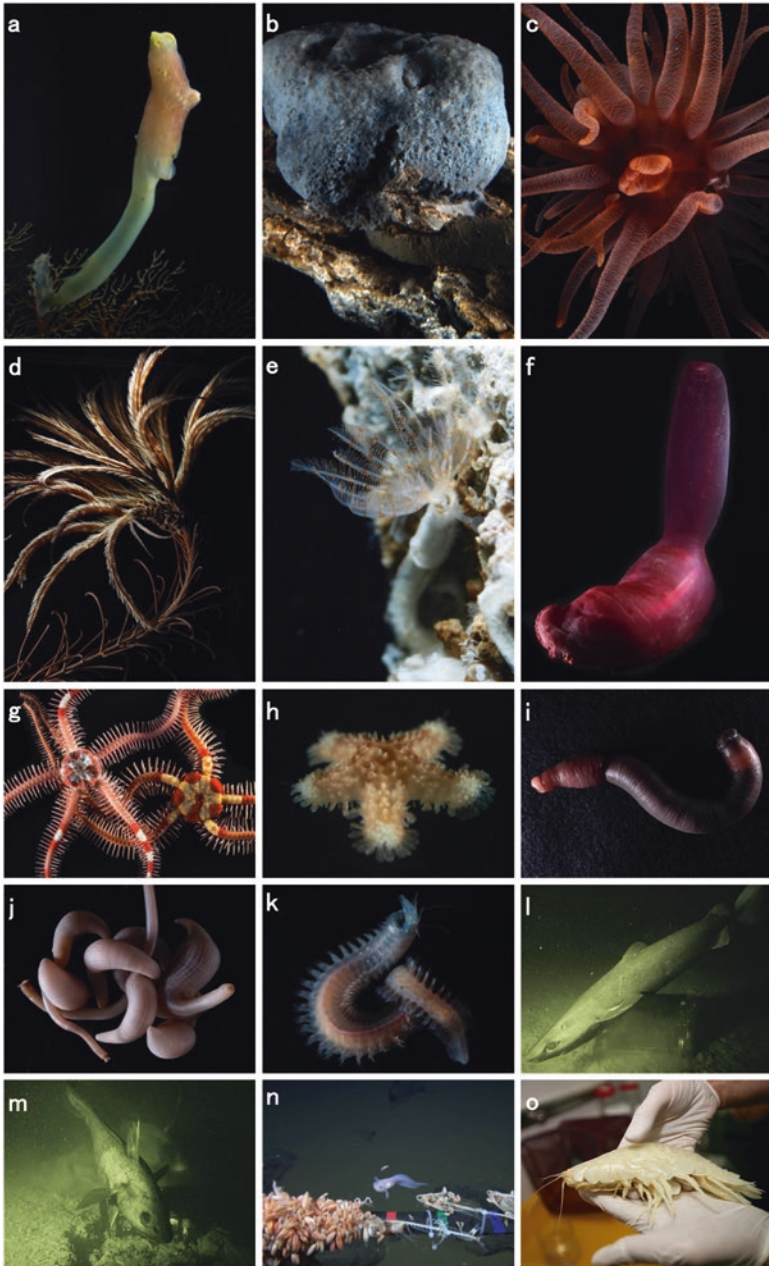
Only about 1–3% of surface production reaches the deep-sea floor. In contrast, *chemosynthesis*—primary production conducted by autotrophic prokaryotes using energy from the oxidation of inorganic molecules—occurs around hydrothermal vents and hydrocarbon seeps (Van Dover 2000).

### Characteristics of Deep-Sea Fauna

Most animal phyla inhabit the deep ocean, but some benthic taxa appear more frequently in the deep sea (Gage and Tyler 1991). For example, the megafauna in the deep sea consists primarily of demersal fish, decapods, holothurians, asteroids, ophiuroids, and benthic cnidarians. The macrofauna consists primarily of polychaetes, bivalves, and small crustaceans (e.g., isopods, amphipods, and tanaids). The meiofauna consists primarily of foraminifers, nematodes, and harpacticoid copepods. The diet of most deep-sea species is derived from surface produced ‘marine snow’, which is a fragile organic aggregate containing fecal pellets, molts, remains, and mucus-feeding webs. Consequently, detritus feeders (suspension and deposit feeders) are predominant at the deep seafloor (Fig. 21.1). Active suspension feeders, like ascidians and sponges, are common at relatively shallow depths (Fig. 21.2a, b). At increasing depths, suspended loads diminish and passive suspension feeders (e.g., cnidarians, crinoids, and some polychaetes) take the place of active suspension feeders because passive feeders invest less energetic costs to capture prey than do active feeders (Fig. 21.2c–e). Deposit feeders (holothurians, ophiuroids, asteroids, echinurans, sipunculans, and polychaetes) (Fig. 21.2f–k), which are the dominant organisms in abyssal plains, ingest sediment and incorporate its organic material. Elasmobranchs, especially sharks, are the top predators in the



**Fig. 21.1** Schematic drawing of benthic fauna at sedimentary seafloor



**Fig. 21.2** Representative deep-sea fauna around Japan (except **n** and **o**). (**a**) Stalked ascidian, (**b**) Sponge, (**c**) Cnidarian, (**d**) Crinoid, (**e**) Polychaete, (**f**) Holothurian, (**g**) Ophiuroid, (**h**) Asteroid, (**i**) Echiuran, (**j**) Sipunculan, (**k**) Polychaete, (**l**) Roughskin dogfish, (**m**) Pacific grenadier, (**n**) Mariana snailfish from Mariana Trench, (**o**) Giant amphipod from Tonga Trench. (**a–k**) ©Yoshihiro Fujiwara/JAMSTEC, (**l–o**) ©JAMSTEC

upper bathyal zone (Fig. 21.2l). Most predators are necrophagous, probably because of the limited food supply. The deepest record of an elasmobranch was a great lanternshark *Etmopterus princeps* at a depth of 4500 m (Kyne and Simpfendorfer 2010). Bony fish take the role of top predators below the shark habitats (Fig. 21.2m). The deepest record of a fish ever observed in situ was a ‘Mariana snailfish’ at a depth of 8178 m in the Mariana Trench (Fig. 21.2n). Limited information is available on top predators deeper than the ‘fish layer’, but giant amphipods are one of the top predators in hadal trenches (Fig. 21.2o).

### How to Obtain Information on Deep-Sea Life

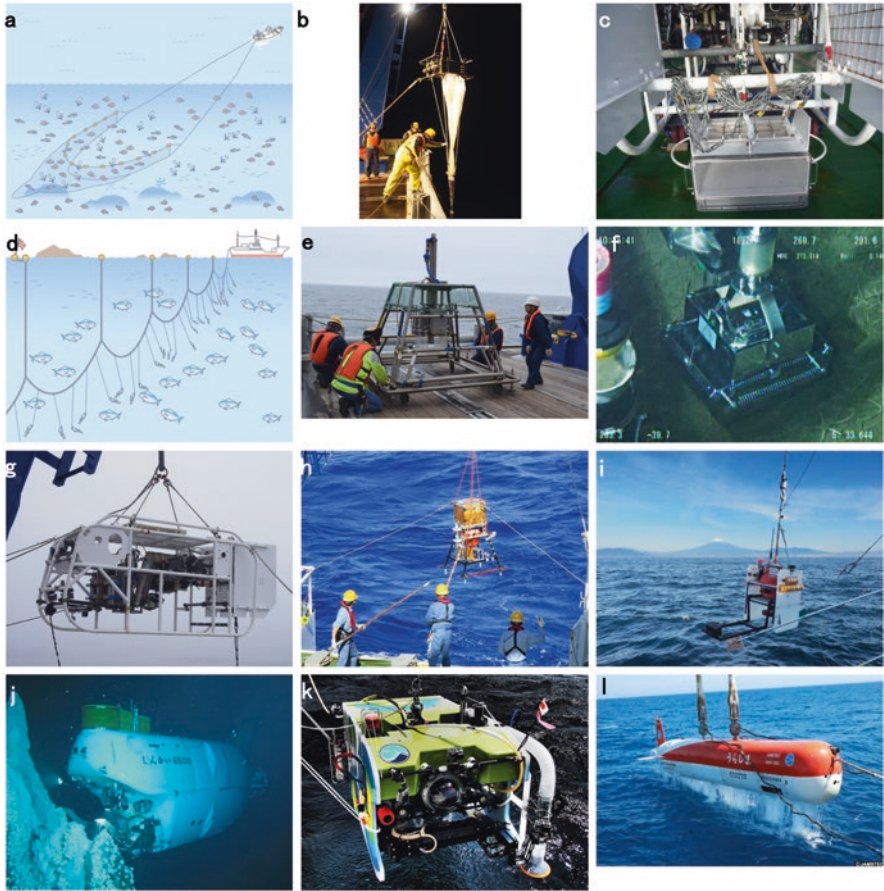
Deep-sea studies thoroughly depend on technology because researchers are not able to access the deep sea without the aid of research devices. No single instrument is sufficient to obtain all biological information from deep-sea environments because the life forms of deep-sea organisms are very diverse, as are their environments. For example, meiofauna can be collected by corers but not by bottom trawls. Biological sampling is very important to understand most aspects of marine life, but imaging is sometimes very informative. It is not easy to conduct quantitative sampling from the deep seafloor, nor to collect intact gelatinous zooplankton. In such cases, photo-mosaic mapping and three-dimensional imaging are very successful, respectively. Imaging is also useful for understanding long-term ecosystem changes by use of a free-falling lander. Therefore, multiple devices are essential for an overall understanding of deep-sea life (Gage and Tyler 1991; Clark et al. 2016). Representative pieces of equipment are shown below.

### Net and Dredge

Trawl nets are used primarily for quantitatively/semi-quantitatively collecting most megafauna (Fig. 21.3a). Smaller organisms are lost through the mesh, while active swimmers can escape from the net. Various types of trawl nets exist. A larger opening of net is more successful at collecting agile species. A plankton net is used for quantitatively collecting plankton in standing water. The standard mesh size is less than 1 mm. Plankton nets can be used vertically and horizontally. A multiple opening/closing net sampler can be applied to understand the vertical distribution patterns of planktonic fauna (Fig. 21.3b). Net sampling covers a relatively wide area but long-term towing may cause damage to the plankton samples and influence the quantitiveness. A dredge is a semi-quantitative sampler to collect benthic epifauna and infauna in sediments (Fig. 21.3c). It predominantly consists of a hard mouth and a collecting canvas bag or steel box. A dredge is towed by ship and is operated blindly, which may cause serious damage to the benthic habitat. To avoid such disturbance, a dredge is sometimes installed with a deep-tow camera system that has real-time vision, and is released and retrieved for viewing.

### Longline

Longlines consist of a long main line and secondary branch lines with baited hooks (Fig. 21.3d) and are used to collect fish. Most fish species caught with longlines are predators and scavengers, some of which are very difficult to capture by any other



**Fig. 21.3** Deep-sea research equipment used in Japan. (a) Bottom trawl, (b) Vertical multiple plankton sampler (VMPS), (c) Dredge installed on deep-tow camera, (d) Longline, (e) Multiple corer, (f) Ekman-Berge bottom sampler, (g) Deep-tow camera, (h) Free-fall lander, (i) Baited camera, (j) HOV *Shinkai 6500*, (k) ROV *Crambon*, (l) AUV *Urashima*. ©JAMSTEC except (a and d) which are copyright-free illustrations shown in the following website: [http://www.maff.go.jp/tokei/census/gyocen\\_illust2.html](http://www.maff.go.jp/tokei/census/gyocen_illust2.html)

method. Therefore, longline surveys are important for understanding fish diversity and abundance. They are simple to operate, cost-effective, applicable to rough areas and steep terrain, and less impactful than bottom trawls.

### Sediment Sampler

The multiple corer can be used to collect sediment samples containing infauna, especially macro- and meiobenthos (Fig. 21.3e). It consists of a coring head, core tubes, and top- and bottom-closure mechanisms. The corer is lowered from a ship using a winch rope. When it lands on the bottom, coring tubes descend and penetrate the sediment. The bottom-closure mechanisms start working when the coring head

reaches a certain position. This type of corer is able to collect quantitatively small numbers of infauna but is not suitable for larger samples because of the small diameter (about 5–10 cm) of the tubes and relatively small coverage area. An Ekman-Berge bottom sampler can be used to collect sediment samples like a multiple corer, but was originally developed for shallow-water exploration (Fig. 21.3f). In the deep sea, it is operated by use of a manipulator installed on both human occupied vehicles (HOVs) and remotely operated vehicles (ROVs) and can be applied for the quantitative sampling of a spatially localized target.

### **Deep-Tow Camera**

The deep-tow camera can be used to conduct real-time observations in the deep sea and to obtain photographs and video clips (Fig. 21.3g). It is deployed from a research vessel using a winch cable and has no self-propelled ability. It can carry physicochemical measurement devices, such as a conductivity-temperature-depth (CTD) sensor. The positioning of the camera is monitored by the use of acoustic positioning systems. It is easier to operate than HOVs and ROVs and has a wider investigation range. Therefore, it is often used for preliminary site surveys before conducting HOV/ROV dives. It has no sampling ability in itself, but a small dredge or plankton net is sometimes installed for sample collection.

### **Free-Falling Lander and Baited Camera**

The free-falling lander can be used for stationary measurements and observations for long periods (Fig. 21.3h). It consists of a main frame, video/still camera systems, lights, physicochemical sensors (e.g., CTD, dissolved oxygen sensor, and current profiler), batteries, buoyancy materials, ballast, and an acoustic releaser. It is deployed from a ship in free-fall mode. The ballast is released by the acoustic releaser according to the release command from the ship. Its observation period is determined by its electric capacity and consumption. It is possible to conduct an annual monitoring. A baited camera is a similar system to the free-falling camera but has a bait that attracts predators and scavengers (Fig. 21.3i). It is used to investigate the diversity and biomass of predators/scavengers. The deployment period of a baited camera is relatively short due to the deterioration of the bait effect.

### **Human Occupied Vehicle, Remotely Operated Vehicle, and Autonomous Underwater Vehicle**

Both HOVs and ROVs are used for precise and selective operations that cannot be achieved using any other devices (Fig. 21.3j, k). A HOV carries people (one to three people in general) under the surface of the water and is directly operated by humans. It is untethered and decoupled from the support vessel, which allows it flexible operation both in mid-water and benthic terrain. An ROV is coupled to the support vessel via a tether cable and is operated from the vessel. ROV operations are affected by sea state, wind, and current. Both HOVs and ROVs are highly maneuverable and can access complex terrain, such as hydrothermal vent sites. These vehicles commonly have manipulator(s) and a suction sampler to conduct precise sampling, but total amount of samples possible is much less than that of other methods. The

positioning of the vehicles is monitored by the use of acoustic positioning systems. An autonomous underwater vehicle (AUV) is an untethered robot that can conduct research without input from the surface during operations (Fig. 21.31). It is useful for photomosaic mapping and for diving surveys at inaccessible locations such as under ice. All of these vehicles are much more expensive to use than the other above-mentioned equipment and require highly trained and skilled operators.

---

## References

- Clark, M. R., Consalvey, M., & Rowden, A. A. (2016). *Biological sampling in the deep sea*. West Sussex: Wiley.
- Connelly, D. P., Copley, J. T., Murton, B. J., Stansfield, K., Tyler, P. A., German, C. R., et al. (2012). Hydrothermal vent fields and chemosynthetic biota on the world's deepest seafloor spreading centre. *Nature Communications*, 3, 620. <https://doi.org/10.1038/ncomms1636>
- Gage, J. D., & Tyler, P. A. (1991). *Deep-sea biology*. Cambridge: Cambridge University Press.
- Herring, P. (2002). *The biology of the deep ocean*. New York: Oxford University Press.
- Kyne, P. M., & Simpfendorfer, C. A. (2010). Deepwater chondrichthyans. In J. C. Carrier, J. A. Musick, & M. R. Heithaus (Eds.), *Sharks and their relatives II* (pp. 37–113). Boca Raton, FL: CRC Press.
- Van Dover, C. L. (2000). *The ecology of deep-sea hydrothermal vents*. Princeton, NJ: Princeton University Press.



Ben P. Harvey, Koetsu Kon, and Sylvain Agostini

## Abstract

Marine ecology is about the study of living things in the ocean and how they interact with their environment. A central aspect of marine ecology is therefore understanding what, where, and when species are located in the marine environment. When we wish to know what fauna and flora are present in a particular habitat, it would not typically be feasible to simply count every individual of every species present (as this would be hugely time consuming and logistically difficult). Instead, survey techniques can be used to break this onerous task down into ‘samples’, which together give a representative assessment of the habitat in general, providing important information on the species composition, density, and structure of communities (while being achievable in a more realistic time-frame). A number of different survey techniques exist for assessing species abundance and distribution, each more suitable for answering particular questions, or for making assessments of particular habitats, taxonomic groups, and/or body sizes. In this section, we will outline the most common survey techniques used in marine ecology and indicate some of the considerations needed for using each approach.

## 22.1 Random and Stratified Random Sampling

One of the fundamental tenets of survey techniques in the marine environment is that the most suitable approach will depend on the scientific question being asked, and feasibility due to the habitat being assessed (e.g., intertidal, subtidal, or deep-ocean). However, one aspect which is important across all survey techniques is

---

B. P. Harvey (✉) · K. Kon · S. Agostini  
Shimoda Marine Research Center, University of Tsukuba, Shimoda, Shizuoka, Japan  
e-mail: [ben.harvey@shimoda.tsukuba.ac.jp](mailto:ben.harvey@shimoda.tsukuba.ac.jp)



‘random sampling’ (Jones et al. 1980). At its most simple, random sampling assumes that all areas of a site have an equal chance of being sampled, and the locations being sampled are chosen at ‘random’ (e.g., by throwing a quadrat or using a random number table) and importantly are not being chosen by the researcher. This approach removes any potential bias by the researcher, as we will often focus on the habitats or organisms that are the most interesting or different. Additionally, many of the common statistical techniques used have the assumption that the data is randomly collected. ‘Random sampling’ involves taking large numbers of samples within a particular habitat, meaning that it is possible to gain a representative assessment of the species present within a given habitat. This type of random sampling is most commonly used when the habitat being investigated is fairly homogenous, and when a large area needs to be assessed in a reasonably short time period (often due to time constraints, e.g., tides or daylight hours).

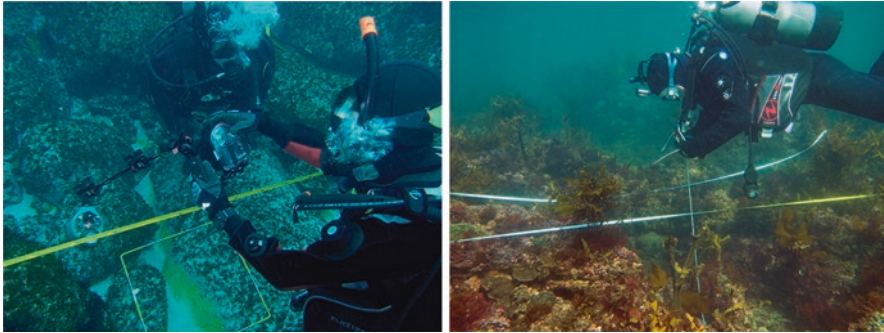
Sometimes the habitat being investigated is not uniform and will instead have a number of different areas that can be clearly identified from the main habitat (e.g., tide pools within the rocky intertidal shore, or sand patches between kelp beds). If random sampling was used to assess this habitat, then (just due to chance) some areas would be oversampled and some other areas would be undersampled (or possibly even missed). This could mean that the assessment is no longer representative of the study area. In order to capture these different areas within the overall habitat requires samples to be taken in each area separately, which is called ‘stratified random sampling’. As the concept of *random sampling* is that every point has the same chance of being chosen, it is also necessary to make the number of samples proportional to the area of each smaller habitat type (e.g., if tide pools make up 10% of the study area, then only 10% of the samples should be carried out in tide pools, with 90% in the other areas).

---

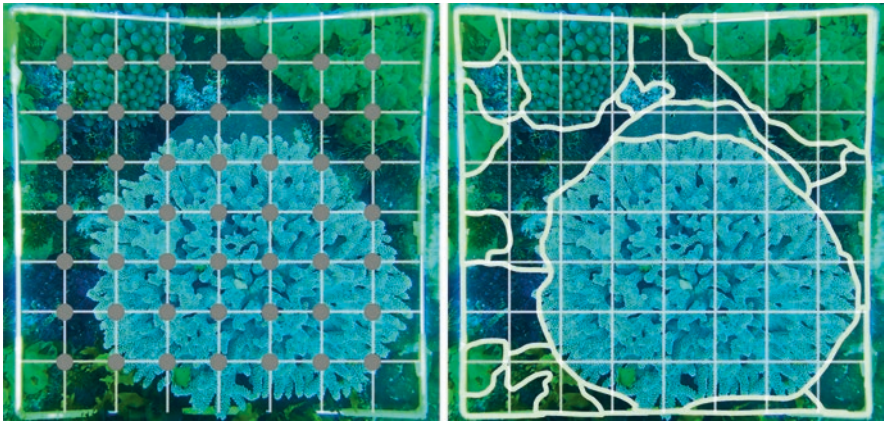
## 22.2 Quadrats, Abundance and Diversity Measurements (What Is Being Measured?)

The most common technique for performing either *random sampling* or *stratified random sampling* is the use of a quadrat (Pound and Clements 1898). Quadrats normally consist of a square frame, the most frequently used size being 50 × 50 cm (see Figs. 22.1 and 22.2), although other sizes can be used depending on the size and typical abundance of the study organism. The frame is placed on whatever is being investigated and the organisms inside it are counted or measured. This then provides comparable samples using a consistent size and shape, which, after being carried out a large number of times (see Sect. 22.3), can then be used for subsequent statistical analysis.

When assessing the abundance or diversity of marine organisms, two main measurements are used during surveys: *counts* and *percentage cover* (Wheater et al. 2011). The method used is essentially dependent on the species being investigated, or the aim of the survey. *Percentage cover* is useful for species that are either colonial organisms (e.g., corals) or small organisms (e.g., barnacles), as well as



**Fig. 22.1** Examples of field survey techniques. Left: Photo-quadrats along belt transect. Right: point intercept transect



**Fig. 22.2** Figure comparing ‘visual estimate’ and ‘line-point intercept’ method when measuring with a quadrat (e.g., the large coral colony covers approximately 42% by visual estimate, and can be found under 30 of the 64 points (~47%) by line-point intercept)

macroalgae species, as these are all relatively impractical to count individually. *Percentage cover* can either be a visual estimate (an estimation of how much of the quadrat is taken up by each species) or a point intercept within the quadrat (using a quadrat with both horizontal and vertical lines, and recording what is beneath the intersecting lines) (see Fig. 22.2). *Counts* are commonly used for larger and/or mobile organisms (e.g., fishes and crustaceans) where the individual is easily identified.

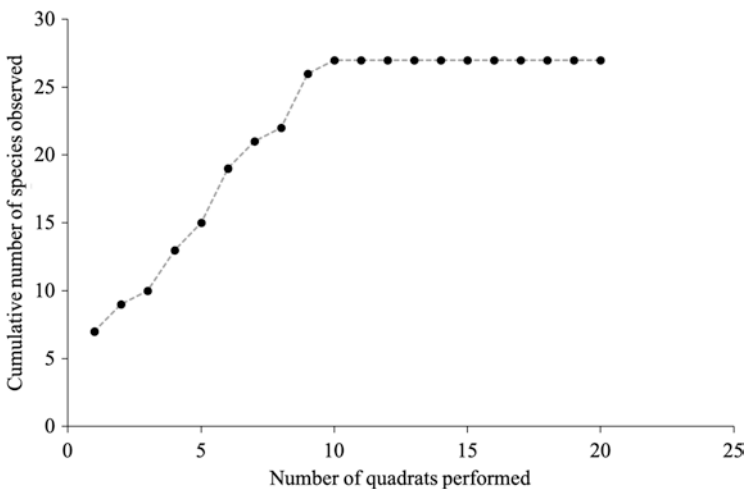
For both *percentage cover* and *counts*, it is possible for the researcher to either visually record the measurements in the field (using a datasheet), or to use photo-quadrats, where photographs are taken of the quadrat in the field, and are then subsequently analysed using a computer back in the lab (George 1980). The advantage of photo-quadrats is that they will require less time in the field, and as they are analysed by computer, they can provide a more accurate estimate of percentage

cover. They will, however, require additional time afterwards in the lab for analysis, and can make species identification more difficult (as species can be more closely inspected and more easily taxonomically identified while still in the field). Subsequently, care must be taken that any photo-quadrats are of sufficient quality (before leaving the field site).

### 22.3 How Many Samples (Replicates)?

In order to obtain a truly representative assessment of a particular habitat, the researcher needs to ensure that they collect a sufficient number of samples (Raffaelli and Hawkins 1996). Subsequently, it is often necessary to estimate how many samples should be taken at each sampling period. The bare minimum will always be three (the minimum required to calculate variance), and the maximum will be limited by time and money. Therefore, a balance needs to be made to ensure that sufficient replication is carried out in order to answer the scientific question of the survey.

One possible approach is to see how the cumulative number of species being recorded increases as more quadrats are carried out. For example, in Fig. 22.3, it can be seen that after 10 quadrats no new species are being observed, and therefore (for this particular habitat) a minimum of 10 quadrats is necessary.



**Fig. 22.3** Example of how to calculate the minimum number of samples (here, quadrats) required to be considered a representative measure of species richness for a given habitat. Here, the cumulative number of species being observed increases as more quadrats are performed. However, no new species are observed after 10 quadrats—suggesting the minimum replication required. Note: this number differs between habitats and locations

## 22.4 Continuous and Systematic Sampling (Transects)

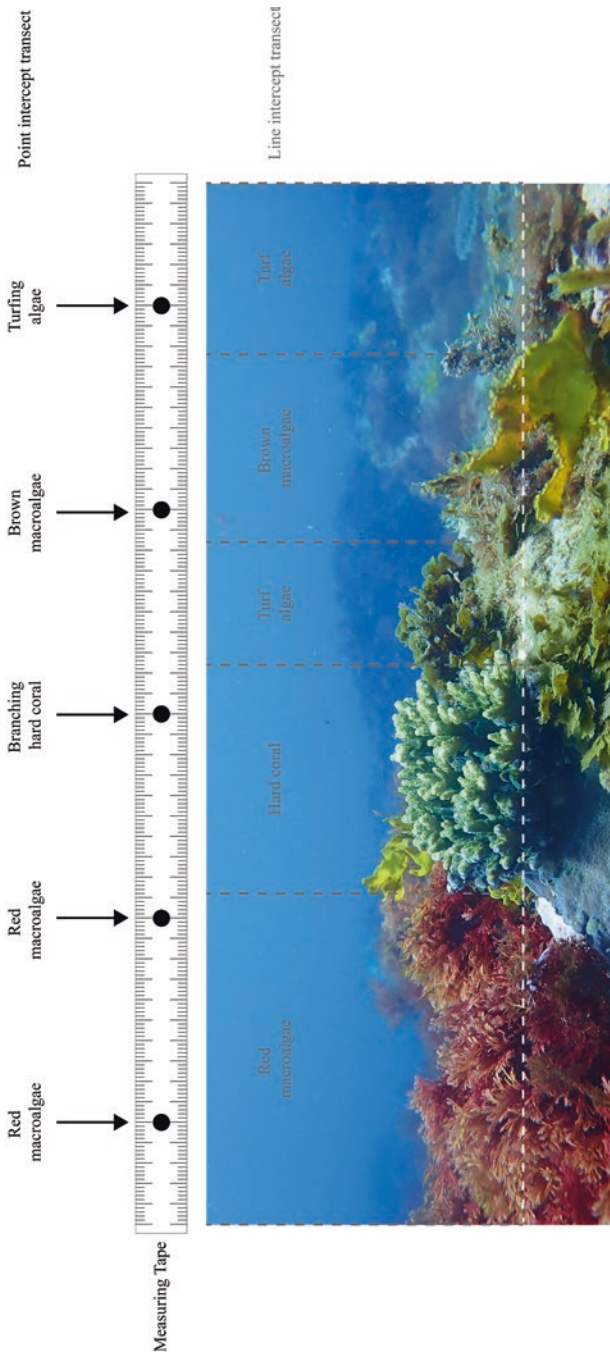
*Transects* are another ecological tool that allow the researcher to quantify the relative abundance of organisms in an area (Raffaelli and Hawkins 1996). The transects outlined below will most commonly focus on sessile organisms (with more mobile fauna requiring alternative approaches, as described in Sect. 22.6). This approach involves taking samples continuously (termed *continuous sampling*) or at fixed intervals along a line (termed *systematic sampling*), often using a measuring tape (Fig. 22.4). Transects will typically be used when some form of clear environment gradient exists (e.g., tidal height on the rocky intertidal shore, or distance from a point source of pollution). The transect is then placed haphazardly (i.e., at random) in the direction of the known gradient, and the chosen sampling approach is carried out along the transect line. The transect itself (placed in a new location) will then be repeated multiple times in order to achieve the necessary replication for later statistical analysis. *Continuous sampling* is achieved using ‘line intercept transects’, which record (roughly every 1 cm) the width of each species along the whole length of the tape by noting the length where there is a change in species (see Fig. 22.4) (English et al. 1997). *Systematic sampling* is achieved using either ‘point intercept transects’ or ‘belt transects’ (Choat and Bellwood 1985). *Point intercept transects* record the objects at set points of the tape measure (e.g., every 1 m along a 50 m tape, what species/group is underneath the tape is recorded), whereas *belt transects* involve placing a quadrat at those fixed intervals instead (e.g., every 1 m along a 50 m tape, a quadrat is placed and the contents are counted/measured) (see Fig. 22.4).

With the various methods, *point intercept transects* represent a relatively time- and cost-efficient approach (suitable for when time limitations exist). This is because *point intercept transects* are faster than *line intercept transects* and *belt transects*. However, they also provide the simplest information. *Line intercept transects* can also provide population densities by assessing the number of individual colonies in a given area, and an advantage of *belt transects* is that you also acquire information on abundance rather than just the presence/absence of species along the transect. It should be noted that both *point intercept transects* and *line intercept transects* are less sensitive to small scale spatial variation than *quadrats* and *belt transects*.

---

## 22.5 Visual Census Survey (Mobile Organisms)

For mobile organisms in the subtidal zone (e.g., fishes), the above approaches of quadrats and transects are less suitable for determining the abundance, size, and species composition. It is therefore better to use a *visual census survey* (Brock 1954, 1982), which also lays down a transect (measuring tape) and counts the organisms within a defined area (often 2 m either side of the measuring tape). The typical lengths of a transect is 25–50 m. Using this approach (and with practice), it is also possible to estimate the size of your study organisms. Although recording is normally performed by the scuba diver themselves, it is often advisable to use



**Fig. 22.4** A comparison of point intercept transects (black) and line intercept transects (grey) on the same area of reef. Point intercept record the species or group under the tape measure at fixed intervals. Line intercept transects record the width of each species along the whole length of the tape by noting the length where there is a change in species

a video or stereo-video system as well (video allows the confirmation of species identification, and stereo-video enables accurate measurements of the size afterward in the lab).

## 22.6 Ship-Based Sampling Techniques (Trawl, Dredge, and Grab Sampling)

The survey techniques described thus far have been methods that are typically carried out by the researcher themselves either intertidally or subtidally using snorkeling or scuba diving (depending on the depth). Generally, these approaches consider organisms that are of sufficient body size to be identified and counted/measured with relative ease. However, for some organisms, it is necessary to perform identifications and measurements in the laboratory (e.g., requiring the use of a microscope) or sample at greater depths than those achievable using scuba diving. The alternative techniques that can be used for sampling the organisms on the seabed are *trawls*, *dredges*, and *grabs* (Fig. 22.5) (Kaiser and Brenke 2016; Clark et al. 2016).

Both *trawls* and *dredges* are towed behind the vessel and along the seabed in order to sample organisms. *Trawls* skim the surface of the seafloor, whereas *dredges* are typically heavier and therefore dig into the sediment. In both cases, they are towed behind the ship (travelling at a constant speed) for a fixed duration (often 30 min to 1 h). *Trawls* are therefore aimed at sampling epifauna (organisms living on the seabed), and *dredges* are aimed at sampling both epifauna and infauna (those organisms living within the sediment of the seabed). Following this, the samples are brought onto the deck of the vessel, and the sediment is sieved to eliminate the particularly fine sands, silts and mud, allowing the remaining organisms to be set aside for laboratory analysis. Due to the time required to carry out multiple *trawls* or *dredges*, it is typically the time and the cost of the research vessel that will limit the number of replicates that can be performed.

Although it is possible to perform multiple *trawls/dredges*, the method is less quantitative because it is more difficult to standardize the samples. *Grabs* can instead be used to collect samples in a more comparable manner (Blomqvist 1991). A number of different types of *grabs* exist, depending on the sediment properties of

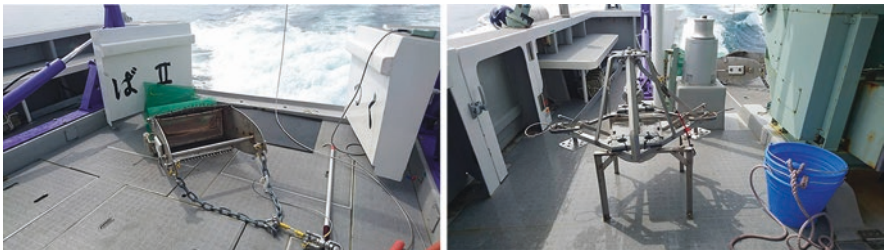
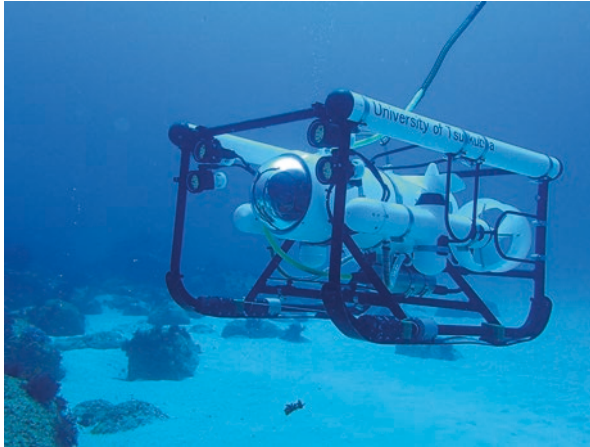


Fig. 22.5 Example of dredge, and grab sampling



**Fig. 22.6** A Remote Operated Vehicle (ROV). Photo taken at Mikama Bay, Shikine Island, Japan (20 m depth)

the seabed (e.g., mud/sand sediments vs. coarser sediments); however, the main property of all *grabs* is that they have two open jaws which then quickly close as they touch the seabed (see Fig. 22.5). As such, one of the key differences between *grabs* and *trawls/dredges* is that due to being deployed vertically from the ship, *grabs* can collect a number of relatively standardized samples from particular places (compared to the more general area sampled by *trawls* and *dredges*). *Grab* samples are processed in a similar manner to *trawls* and *dredges*, going through an initial sort on the deck of the vessel, with the main analysis performed in the laboratory.

---

## 22.7 Remotely Operated Vehicles (ROV)

When surveys are being conducted in particularly deep waters (>50 m), either images or videos can be collected using an *ROV*, which is controlled by someone on the research vessel (see Fig. 22.6). The *ROV* itself remains connected to the research vessel by an umbilical cable, which can provide real-time videos of the seabed, or be used to take still images of anything of interest. As natural light becomes limited at depth, *ROVs* are equipped with lights, which allows for surveys to be carried out under a range of conditions. This traditionally means that the maximum accessible depth for *ROV* surveys is often only limited by the length of the umbilical cable. The techniques described for *quadrats* (Sect. 22.2), *transects* (Sect. 22.4), and *visual census surveys* (Sect. 22.5) can be applied to *ROVs*, enabling surveys to be carried out in a range of different habitats.

## References

- Blomqvist, S. (1991). Quantitative sampling of soft-bottom sediments: Problems and solutions. *Marine Ecology Progress Series*, 72, 295–304.
- Brock, R. E. (1982). A critique of the visual census method for assessing coral reef fish populations. *Bulletin of Marine Science*, 18, 297–276.
- Brock, V. E. (1954). A preliminary report on a method of estimating reef fish populations. *Journal of Wildlife Management*, 18, 297–308.
- Choat, J. H., & Bellwood, D. R. (1985). Interactions amongst herbivorous fishes on a coral reef: Influence of spatial variation. *Marine Biology*, 89, 221–234.
- Clark, M. R., Bagley, N. W., & Harley, B. (2016). Trawls. In M. R. Clark, M. Consalvey, & A. A. Rowden (Eds.), *Biological sampling in the Deep Sea* (pp. 126–158). West Sussex: Wiley Blackwell.
- English, S., Wilkinson, C., & Baker, V. (1997). *Survey manual for tropical marine resources* (p. 378). Townsville, QLD: Australian Institute of Marine Science.
- George, J. D. (1980). Photography as a marine biological research tool. In J. H. Price, et al. (Ed.), *The shore environment: 1. Methods*. Systematics association special volume, 17(a) (pp. 45–115). London: Academic Press.
- Jones, W. E. Bennell, S. Beveridge, C. McConnell, B. Mack-Smith, S. Mitchell, J. Fletcher, A. (1980). Methods of data collection and processing in rocky intertidal monitoring. In J. H. Price, et al. (Ed.), *The shore environment: 1. Methods*. Systematics association special volume, 17(a) (pp. 137–170). London: Academic Press.
- Kaiser, S., & Brenke, N. (2016). Epibenthic sledges. In M. R. Clark, M. Consalvey, & A. A. Rowden (Eds.), *Biological sampling in the Deep Sea* (pp. 184–206). West Sussex: Wiley Blackwell.
- Pound, R., & Clements, F. E. (1898). A method of determining the abundance of secondary species. *Minnesota Botanical Studies*, 2, 19–24.
- Raffaelli, D. G., & Hawkins, S. J. (1996). *Intertidal ecology*. London: Chapman and Hall.
- Wheater, C. P., Bell, J. R., & Cook, P. A. (2011). *Practical field ecology: Project guide* (p. 388). Hoboken: Wiley. ISBN: 978-0-470-69428-2.





Koetsu Kon, Hideyuki Yamashiro, Masahiro Horinouchi,  
and Shun Kawaida

## Abstract

Ecological phenomena are usually complex because of natural variability in space and time, which in turn often makes the interpretation of results from field surveys difficult. To compensate for survey weakness, field/laboratory experiments are often applied to marine ecological studies. Well-designed experiments can discern between each ecological process, and consequently help to understand ecological mechanisms. This section describes practical examples of field/laboratory experimental methods, including those studying predation impacts, consumption rates, behavioral tactics, and symbiotic interactions.

## 23.1 Field Experiment: Evaluation of Fish Predation Risk Patterns

Fish are not distributed evenly, showing preferences for specific habitats and microhabitats. Such distribution patterns are influenced by various factors including predation, prey abundance/accessibility, or competitor densities. Of these factors, predation is considered especially important, playing a significant role in generating habitat specific patterns, either directly by the removal of prey fish or indirectly inducing habitat selection in prey fish. For example,

---

K. Kon (✉)

Shimoda Marine Research Center, University of Tsukuba, Shimoda, Shizuoka, Japan  
e-mail: [kon@shimoda.tsukuba.ac.jp](mailto:kon@shimoda.tsukuba.ac.jp)

H. Yamashiro

Sesoko Station, Tropical Biosphere Research Center, University of the Ryukyus,  
Nishihara, Japan

M. Horinouchi · S. Kawaida

Aquatic Ecology Division, Estuary Research Center, Shimane University, Matsue, Japan

seagrass habitat is generally recognized to have larger numbers of fish compared with adjacent bare sand/mud and serves as a nursery for a variety of coastal fish, such habitat use patterns often being attributed to lower predation risks resulted from the sheltering effects of seagrass habitat complexity. To prove such explanation to be appropriate, it is essential to ascertain that the predation risk is actually lower in the seagrass habitat compared with the bare sand/mud area.

A tethering experiment is one of the methods often employed to evaluate relative predation risk patterns across habitats. This method examines loss rates of the experimental fish tethered in target habitats for a set amount of time. The tether usually comprises a thin transparent monofilament line with one end connected to the device such as iron peg (sometimes a more complex device is employed), fixed to the substratum (Fig. 23.1a). The other end is attached to the fish directly by sewn to certain body part, or alternatively, is equipped with a small fishing hook at its tip and then the latter is hooked on the part (Fig. 23.1b). In other attachment technique, the free end is threaded mouth-operculum opening cavity of the fish, and then tied to the tether in front of its mouth (Fig. 23.1b). Anyway, tether-to-fish attachment procedure should be conducted carefully and also quickly so as to minimize damage to fish as much as possible. Light anesthesia may make it easier, although if employed recovery time should be established before deployment in a field.

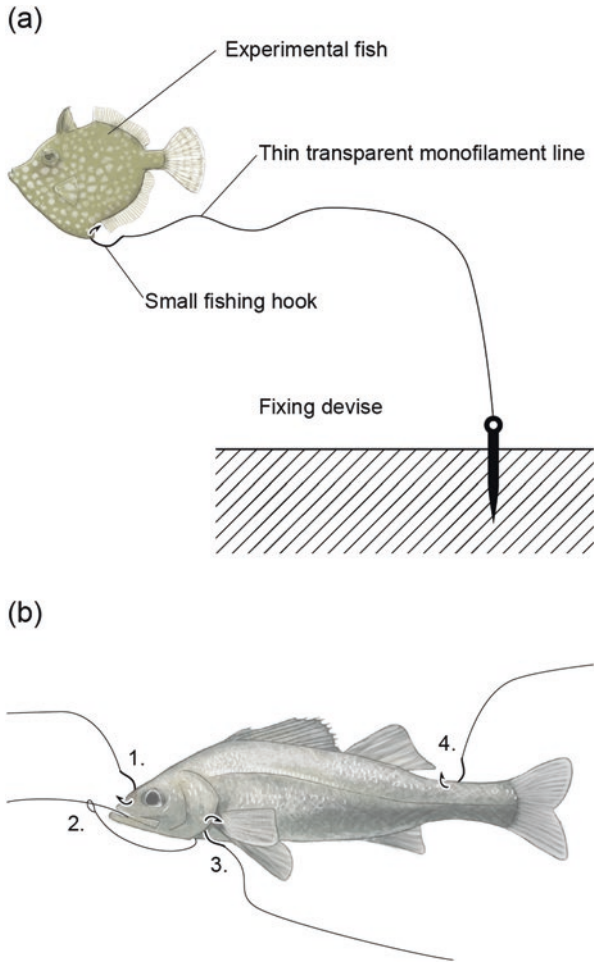
### Outline of the Procedure

#### 1. Collection and maintenance of experimental fish.

Target fish are collected from areas near the study sites, and maintained in tanks for a while. Individuals fit for study purposes are selected and subjected to next steps.

#### 2. Preliminary trials

Attachment techniques are invasive sometimes causing abnormal behaviors of or even death to the tethered fish. Besides, the tether might come off the fish during an actual trial. Thus preliminary trials are needed to find out appropriate attachment position (i.e., body parts) to reduce such defects as much as possible. In case defects are suggested to be not negligible, it may be better to establish predator-free control quadrats in the study area and check mortality rate of the tethered fish and tether-come-off rate in the quadrats in a trial. In previous studies, tethers were attached to various positions including nostril, jaw, operculum, or caudal peduncle [see, for example, Hammerschlag et al. (2010), Horinouchi et al. (2013), Nanjo et al. (2014). See also Fig. 23.1b]. Other conditions such as tether length and trial time should also be determined preliminarily. Short tether may restrict fish movements excessively, while long one may be entangled, especially in habitats with complex structures, also distorting fish behaviors severely. Short trial time may not allow predators to catch enough number of the tethered fish, while long trial time may result in complete loss of

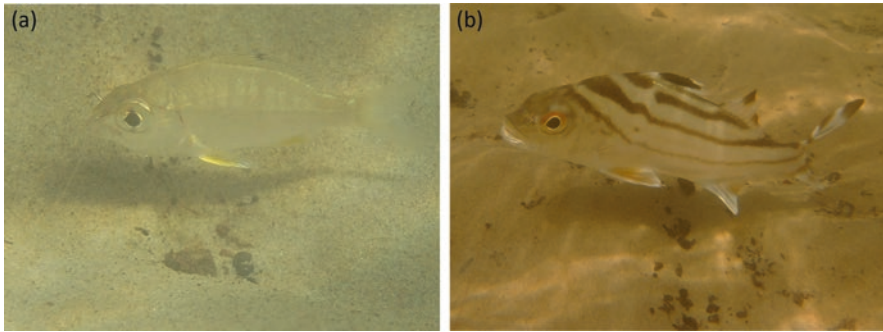


**Fig. 23.1** (a) Examples of the basic structure of a tether and (b) of the attachment position of the tether

the tethered fish, both failing to detect possible differences in predation risks among target habitats.

### 3. Deployment in the field

Following the experimental design, a certain number of quadrats of certain dimension are established within each target habitat. In each quadrat, a certain number of tethered fish are deployed, the other ends of tethers being fixed to the substratum. After being soaked for a set amount of time, presence/absence of each tethered individual is checked, and if predators remain at tethers, they are identified and their body dimensions measured (Fig. 23.2). In general, absence is regarded as the evidence of predation and absence rates are compared among target habitats to evaluate relative predation risk patterns,



**Fig. 23.2** (a) A tethered prey fish and (b) a predatory fish that remained at the tether at the end of the trial in the experiment of Nanjo et al. (2014) conducted in the Urauchi River, Iriomote Island, Okinawa, Japan

although modifications may sometimes be needed based on the results in control quadrats (see above).

A tethering experiment can also be used to evaluate relative predation risk patterns across levels of other factors. For example, if its design includes multiple time zones and/or prey-fish size classes, the experiment may be able to evaluate also temporal and/or size-dependent risk patterns. It should be noted, however, that this method can only provide relative predation rates rather than actual rates, and thus the obtained results should be interpreted carefully.

## 23.2 Field Experiment: Assessments of Leaf Litter Consumption by Sesarmid Crabs

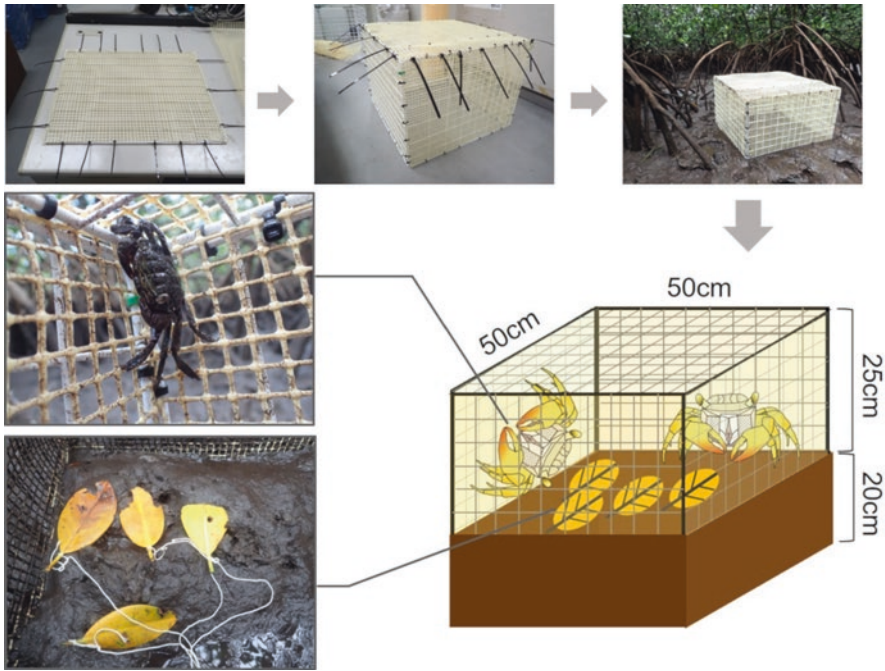
Some macrobenthos—particularly sesarmid crabs—process large amounts of mangrove leaf litter through direct grazing. They ingest the leaf litter and the remains are returned to the sediment in the form of partly digested faeces. This reduces the export of leaf litter by tidal flow, accelerating the subsequent microbial breakdown, and generating fine particles suitable for other deposit feeders. Studies on clarifying the potential role of sesarmid crabs in organic matter cycling in mangrove ecosystems need to examine their leaf litter consumption rate.

A cage experiment is a useful method to estimate the consumption rate by herbivores, predators, and detritivores. This method examines the loss rates of food items by target consumers in an enclosed area for a set amount of time. We here describe a practical method in which the leaf litter of *Rhizophora stylosa* was offered to the sesarmid crab *Parasesarma bidens*.

### Outline of the Experiment

#### 1. Structure and arrangement of the cage

Plastic nets with an aperture of 1 cm are attached to the top and sides of a 5 cm mesh wire cage (50 × 50 cm), which is sunk 20 cm into the sediment so as



**Fig. 23.3** Design of a field cage experiment for measuring the consumption rate of mangrove leaf litter by sesarmid crabs

to limit invasion by burrowing macrobenthos or escape by *Parasesarma bidens* (Fig. 23.3). Three replication blocks are established under the mangrove forest, approximately 10 m from each other.

## 2. Sampling of the materials

*Parasesarma bidens* individuals are captured from the forest floor in the vicinity of the experiment area and maintained in laboratory tanks until beginning of the experiment. Yellow senescent leaves, just before falling, are also collected from mangrove trees. A preliminary quantitative sampling is necessary to clarify the natural crab density, as well as leaf litterfall amount during the period corresponding to the experimental duration.

## 3. Before and after the experiment

The cage is set several days before the beginning of the experiment to stabilize the internal sediment conditions. After the acclimation, crabs and pre-weighed leaves are added to the cage and maintained from a few days to 1 week. A 50 cm twine is tethered to the petiole of a leaf and the other end attached to the mesh of a cage, so as to not be fully buried and lost (Fig. 23.3). The consumption rate of leaf litter by the crabs is assessed by subtracting the weight (g) of the leftovers from that of the initial offering.

### 23.3 Laboratory Experiment: Estimation of Shell-Choice Tactics in Hermit Crabs

Hermit crabs carry gastropod shells as mobile shelters against predators and harsh environmental conditions. The shells are an essential resource for their survival, growth, and reproductive success. Hence, shell-choice is generally very important for most hermit crab species, and, thus, they carefully choose optimal shells in terms of size, weight, and shape.

*Pagurus filholi*, characterized by a bigger right cheliped, banded-patterned antennae, and white-tipped legs, is one of the most dominant Paguroidea species on temperate rocky shores, including those in Japan (Fig. 23.4). Their behavioral ecology has been studied, focusing on shell-choice, as well as mating and feeding.

#### Observation of Individual Interactions

Hermit crabs behave differently depending on sex, body size, and the characteristics of the shell they carry. To understand their behavioral tactics, first, we observed the crabs' behavior when they encountered individuals of different sex and body size, and with different shells, in the following manner.

1. Five individuals of different body sizes were chosen. Later, their shield length, carried shell width, carried shell aperture, carried shell length, and sex were determined.
2. A plastic tank was filled with seawater.
3. The above-mentioned five individuals were placed in the plastic tank, and their behavior observed.
4. The crabs' behavior when two individuals encountered one another was described; this continued until all individuals had encountered one another. Observations were carried out until two crabs encountered one another at least three times.
5. The behavioral tactics were compared with those of the other individuals in terms of sex, body size, and the size of the carried shell.



**Fig. 23.4** *Pagurus filholi*. Common hermit crab species on the temperate coasts of Japan

### Observation of Shell Choice

Optimal shells vary with species, sex, and body size of hermit crabs. Therefore, crabs have shell-choice criteria that depend on their own condition. To understand shell-choice tactics, we examined the shell preference of hermit crabs by providing different species and shells of different sizes in the following manner.

1. Eight individuals of different body sizes were chosen and their shield length, carried shell length, carried shell width, carried shell aperture, and sex were determined.
2. Eight plastic tanks were filled with seawater.
3. Five gastropods shells (e.g., *Monodonta confusa*) were placed into four of the plastic tanks, and five shells of other species (e.g., *Nerita albicilla*) were placed in the remaining four tanks.
4. One individual, characterized above, was placed into each plastic tank, and their shell-choice behavior was observed. The observation was terminated within 1 h.
5. The shell length, shell width, and aperture width of the replaced shells were measured, once the crab changed its carried shell. The shell sizes before and after replacement were compared.
6. The shell-choice tactics were compared in terms of sex, body size, shell size, and shell species.

---

## 23.4 Laboratory Experiment: Assessments of Coral Morphology and Zooxanthellae Density

Most reef-building corals belong to the order Scleractinia (subclass Hexacorallia, class Anthozoa, phylum Cnidaria) and host numerous symbiotic algae (dinoflagellate algae and zooxanthellae) in their endoderm tissues. Approximately 400 species of zooxanthellate coral occur in subtropical to temperate Japan. Corals and coral reefs are important resources. However, they are in crisis due to bleaching (loss of zooxanthellae caused by high water temperatures), predation by starfish, infectious diseases, and pollution (nutrients, chemicals, etc. from run-off). Therefore, to study coral is to learn about the effects of climate change and human activities.

### Fundamental Morphology of Coral Tissue and Skeleton (Figs. 23.5 and 23.6)

Cnidarians (corals, sea anemones, and jellyfish) use nematocysts to defend themselves from enemies and catch food. In zooxanthellate corals, symbiotic algae produce photosynthetic products used by the host coral and facilitate (light-enhanced) calcification. Each coral polyp is surrounded by a cup-shaped corallite. The structure, size, and ornamentations of the skeletal components are used to identify corals.

### Estimation of the Density of Zooxanthellae

Symbiotic algae (zooxanthellae, about 10  $\mu\text{m}$  in diameter) facilitate tissue growth and calcification of the host coral. In studies of the coral–symbiont relationship, it

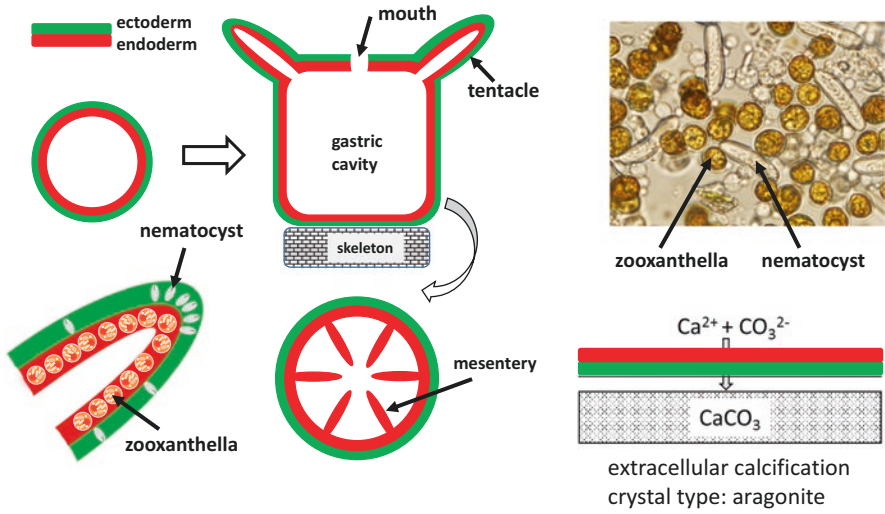


Fig. 23.5 Basic morphology of reef-building coral

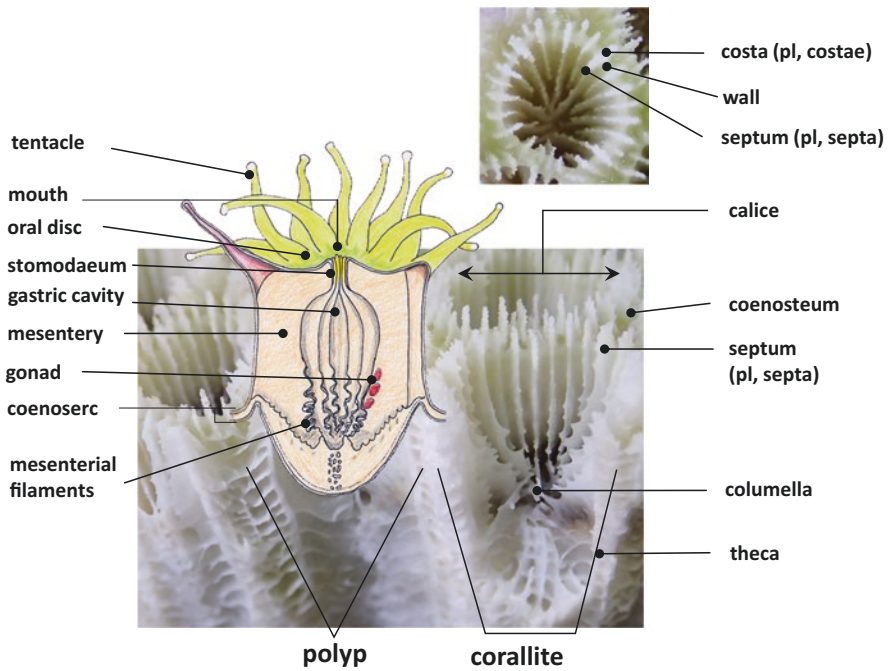
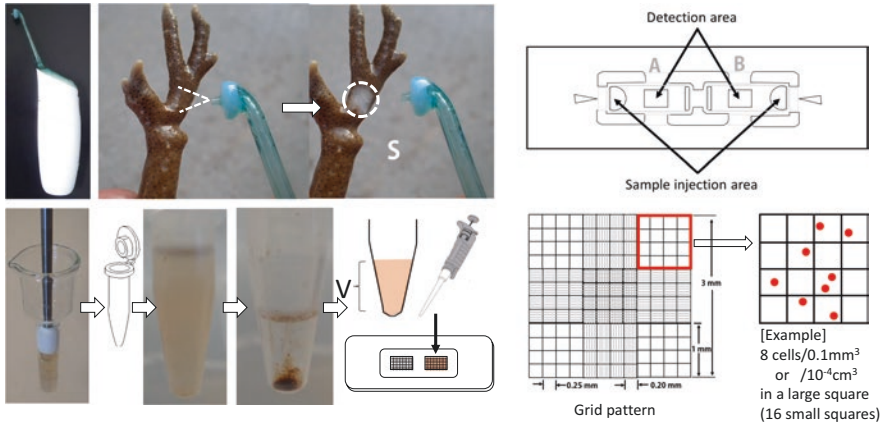


Fig. 23.6 Structure of the soft and hard tissues of coral





**Fig. 23.7** Estimating the density of zooxanthellae

is necessary to estimate the number of zooxanthella cells and determine the conditions affecting their health and productivity, such as the effects of temperature (bleaching) or nutrients.

### The AirFloss Method (Fig. 23.7)

1. Remove the coral tissue using a jet of water (Sonicare AirFloss®, Phillips Ltd.).
  - (a) Fill a tank with seawater (<math><0.2\text{-}\mu\text{m}</math> filtered water is suitable).
  - (b) Blast the coral tissue away several times into a vinyl bag. The coral soft tissue is effectively removed from the skeleton when the AirFloss is less than 1 cm from the coral. Measure the surface area ( $S$  in  $\text{cm}^2$ ) of the denuded tissue for further analysis.
2. Homogenization and purification of zooxanthellae cells.
  - (a) Transfer the slurry solution containing coral tissue and zooxanthellae to a glass homogenizer and grind the slurry several times using an electric drill. Transfer the homogenate to a test tube (e.g., a 1.5-ml micro test tube), and centrifuge it at  $5000 \times g$  for 1 min. Discard the supernatant (coral tissue cells and mucus). Add FSW to the pellet and stir well to resuspend the precipitated zooxanthellae.
3. Repeat step 2 several times to purify the zooxanthellae cells.
4. Count the cells using a hemocytometer.
  - (a) Add a known volume of seawater to the test tube and stir sufficiently. Record the final volume of zooxanthellae solution ( $V$  in ml).
  - (b) With a pipette, load  $10 \mu\text{l}$  (or one drop) of the zooxanthella-suspended water into the sample injection area of a disposable hemocytometer C-Chip® (DHC-N01, Neubauer Improved; NanoEntek, Inc.).
  - (c) Under a light microscope, count the cells ( $C$ ) in a large square of the hemocytometer ( $1 \times 1 \times 0.1 \text{ mm}$  depth,  $10^{-4} \text{ cm}^3$ ). Count the zooxanthella cells in three other large squares.

- (d) Calculate the zooxanthellae density [total number of zooxanthella cells/surface area of coral ( $\text{cm}^2$ )].
- (e) Number of zooxanthellae/ $\text{cm}^2$  = mean number of cells ( $C$ ) counted in a large square of the C-Chip  $\times$  volume of sample solution ( $V$  in ml)/volume of a large square ( $10^{-4} \text{ cm}^3$ )/area of denuded tissue ( $S$  in  $\text{cm}^2$ ).
- (f) For example, when  $S = 1 \text{ cm}^2$ ,  $V = 1.0 \text{ ml}$ , and  $C = 100$  cells in a large square (16 small squares), then the density of zooxanthellae =  $C \times V (\text{cm}^3)/10^{-4} (\text{cm}^3)/S (\text{cm}^2)$ ; =  $100 \times 1.0/10^{-4}/1 \text{ cm}^2$ ; =  $1 \times 10^6$  cells/ $\text{cm}^2$ .

---

## References

- Hammerschlag, N., Morgan, A. B., & Serafy, J. E. (2010). Relative predation risk for fishes along a subtropical mangrove-seagrass ecotone. *Marine Ecology Progress Series*, 401, 259–267.
- Horinouchi, M., Mizuno, N., Jo, Y., Fujita, M., Suzuki, Y., Aranishi, F., et al. (2013). Habitat preference rather than predation risk determines the distribution patterns of filefish *Rudarius ercodes* in and around seagrass habitats. *Marine Ecology Progress Series*, 488, 255–266.
- Nanjo, K., Kohno, H., Nakamura, Y., Horinouchi, M., & Sano, M. (2014). Effects of mangrove structure on fish distribution patterns and predation risks. *Journal of Experimental Marine Biology and Ecology*, 461, 216–225.

---

**Part V**

**Marine Environmental Science**



# Marine Environmental Science Introduction

# 24

Jason M. Hall-Spencer

## Abstract

The marine environmental sciences lay at the interface between physics, chemistry and biology. Training in environmental science techniques provides skills that are highly transferable to the workplace and beyond. This subject typically involves collecting environmental data, collating it and then creating graphs and text to explain the key results. Employers within and outside the marine sciences actively seek people with these skills. Environmental scientists build an ability to conduct risk assessments, prepare reagents, calibrate instruments and design sampling protocols. You learn to plan and assess how to most effectively use your own time and to work in teams to decide upon what to measure to meet a particular set of objectives. By evaluating an environmental problem and honing a set of observations you will use the time-management and communication skills that are required for advising on policy or having input to evidence-based decision-making be it in environmental assessments or in running large organizations.

A basic requirement in marine environmental sciences is that you are able to record your data (singular = datum, or data point) and that you label samples clearly and systematically. Biological variables can be:

1. *quantitative*, these can be continuous (e.g., water temperature throughout the day) or discrete (e.g., number of gastropods in a quadrat),
2. *ranked*, for example, rare = 1, occasional = 2, frequent = 3, common = 4, abundant = 5, superabundant = 6,

---

J. M. Hall-Spencer (✉)

School of Biological and Marine Sciences, University of Plymouth, Plymouth, UK

Shimoda Marine Research Center, University of Tsukuba, Shimoda, Shizuoka, Japan

e-mail: [jhall-spencer@plymouth.ac.uk](mailto:jhall-spencer@plymouth.ac.uk)

© Springer Nature Singapore Pte Ltd. 2020

K. Inaba, J. M. Hall-Spencer (eds.), *Japanese Marine Life*,

[https://doi.org/10.1007/978-981-15-1326-8\\_24](https://doi.org/10.1007/978-981-15-1326-8_24)

285

3. *qualitative* data are described by words or terms, e.g., copepods with eggs or without eggs, or the sea looked light blue, dark blue, light green, dark green or grey.

Quantitative data frequently require use of some kind of instrument and are usually presented with a number and an SI unit (Système International d'Unités) such as second for time or kilogram for weight. Avoid old units, such as knots for nautical speed or fathoms for depth. It is also standard to use litre (l) or millilitre (ml) to express volume if the SI unit of a cubic metre ( $\text{m}^3$ ) is not appropriate. Temperature is usually presented in  $^{\circ}\text{C}$  rather than the SI unit of kelvin (K). Derived SI units are also widely used, such as siemens (S) for electrical conductance ( $\text{s}^3 \text{A}^2 \text{kg}^{-1} \text{m}^{-2}$ ) or newton (N) for force ( $\text{m kg s}^{-2}$ ). Some data are ratios and have no units, such as salinity.

It is important to consider your aims and objectives when collecting data in the laboratory or the field and that these are realistic given the weather conditions or the time available on a machine in the laboratory. What samples and measurements are needed? This will help you then decide what scientific and safety equipment will be required and how samples will be sorted and stored and how these will be transported.

Because seawater salinity, conductivity and temperature are of such major oceanographic and ecological importance, you will likely measure these parameters in most marine environmental studies. If you evaporate a known mass of water to dryness and weigh the salts left behind, this gives a rough idea of the salinity which is around 33 parts per thousand in open ocean seawater and is mainly sodium and chloride. You will more likely measure salinity with an instrument that also measures electrical conductivity and temperature. Water transparency is another parameter of major environmental importance, you may use a simple Secchi disc for that, which you lower and then pull back you until you can first see it to get the Secchi depth. This indicates the depth to which light can penetrate to allow photosynthesis and depends on water colour and suspended solid load. In this chapter we set out how seawater parameters such salinity and temperature as well as particulate organic carbon, dissolved inorganic carbon, nitrate, nitrite, phosphate, silicate dissolved oxygen and Chlorophyll *a* are typically measured in order to assess carbon cycling in marine waters.

Environmental scientific knowledge originates from observations and experiments. A well-rounded marine scientist will have gained experience in collecting abiotic and biotic data both in the laboratory and in the field. They can then put that experience to the test in the design of their own collection of information to answer questions and test their own hypotheses about the marine environment. Safety, ethical and legal aspects should be considered before carrying out marine environmental work—especially if this work involves chemical, physical or biological hazards or if the subjects of the observations are humans or animals. To avoid harm to people and the marine environment there are codes of practice supported by national legislation, particularly around damage to wildlife and implications of your work to others in the laboratory or at sea.

Bioethics is a branch of environmental science that is rather different to practical laboratory and field measurements as it deals with morals, values and ethics. There is seldom a ‘right’ or ‘wrong’ answer to the issue, even if quantitative calculations are involved. Such studies require the same skills of considering issues logically and critically with reasoned arguments. Environmental scientists are increasingly involved in the design of surveys used to weigh-up evidence around issues such as the ways in which fish are killed and seafood is sourced. There are bioethical considerations around the use of transgenic animals and high stocking densities in fish farms. People may be prevented from using the marine environment for cultural reasons (such as the release of marine wildlife during religious festivals) and ethics surround who can do what and where in the marine environment. Informed consent is needed if you wish to conduct surveys involving people, e.g., fishermen or coastal developers about marine environmental issues. For those interested in finding out more about how to train as an environmental scientist I recommend the textbook by Jones et al. (2016).

---

## Reference

Jones, A., Reed, R., & Weyers, J. (2016). *Practical skills in biology* (p. 560). Harlow: Pearson.



Shigeki Wada

## Abstract

Carbon cycling on the earth's surface has been recently focused upon as climate change induced by anthropogenic CO<sub>2</sub> is becoming apparent. Inorganic carbon is fixed by phytoplankton in the surface layer, and a proportion of organic carbon is exported to the deep sea. Since this process contributes to the sequestration of carbon, it is named the 'biological pump'. The dynamics of carbon are closely related to those of other elements. The fixation of carbon by phytoplankton in the surface layer is generally accompanied by the uptake of macronutrients, such as nitrogen, phosphorus, and silica, and the release of oxygen, according to the Redfield ratio. Therefore, quantitative analyses of bioelements and phytoplankton abundance are recognized as the bases of elemental circulation.

## 25.1 Organic Carbon in Seawater

The main sources of marine organic carbon are the photosynthetic products of phytoplankton. In general, organic carbon is operationally categorized into particulate organic carbon (POC) and dissolved organic carbon (DOC) by filtration. Organic carbon collected on the filter are termed POC, and those in filtrate are termed DOC. Since a widely used filter is the glass-fiber filter (Whatman, GF/F) which has a pore size of 0.7 μm, this size is the boundary between POC and DOC fractions. POCs are only minor fraction of the organic carbon in seawater, but this fraction has a great contribution to vertical carbon flux because of its larger size. DOC constitutes

---

S. Wada (✉)

Shimoda Marine Research Center, University of Tsukuba, Shimoda, Shizuoka, Japan  
e-mail: [swadasbm@shimoda.tsukuba.ac.jp](mailto:swadasbm@shimoda.tsukuba.ac.jp)

more than 90% of marine organic carbon and resides in the ocean for several thousand years. Therefore, a huge amount of organic carbon (Carlson and Hansell 2014, p. 662) is reserved in marine environments.

---

## 25.2 Analysis of POC

The filter sample is acidified under acidic vapor by placing with HCl solution in a sealed container, such as a desiccator. By keeping the sample under this condition for 24 h, all inorganic carbon is removed. Thereafter, the sample is dried with phosphorus oxide (V) and sodium hydroxide in a vacuum desiccator for drying and removing acid. The samples are encapsulated in tin foil after drying.

The measurement of POC is generally carried out with an elemental analyzer which combusts at a high temperature (~1000 °C) to break down organic matter into CO<sub>2</sub> and nitrogen oxides (NO<sub>x</sub>). Thereafter, NO<sub>x</sub> is reduced into N<sub>2</sub> gas in a column filled with reduced copper, and CO<sub>2</sub> and N<sub>2</sub> gas are separated with a gas chromatograph. The detection of each gas is achieved by a thermal conductivity detector.

---

## 25.3 Analysis of DOC

There are three major analytical methods for DOC concentrations: wet-chemical oxidation (WCO), UV oxidation, and high-temperature catalytic oxidation (HTCO). Here, we describe the HTCO method, which is widely used in the measurement of DOC in seawater. The filtrate is acidified by the addition of HCl (final conc.: 0.06 N), and purged with high-grade gases (air, N<sub>2</sub>, or He) to remove inorganic carbon. Thereafter, the sample is injected into a column filled with Pt-alumina catalyst. Halogen gases are trapped, and CO<sub>2</sub> gas is detected by non-dispersive infrared (NDIR) detection. In the case that DOC concentrations are low, we have to carefully consider accuracy. The effects of contamination and blanks have been discussed elsewhere (Sharp 1997; Yoro et al. 1999).

---

## 25.4 Nutrients

Macronutrients strongly regulate the growth of phytoplankton (Ryther and Dunstan 1971), and analyses of nutrients are one of the basic parameters to characterize oceanographic settings. Automated instruments are sometimes available, but the principle of the analysis is basically the same as that of manual colorimetric analysis. Here, we describe the assays for nitrate, nitrite, ammonium, phosphate, and silicate based on manual colorimetric methods.



### 25.4.1 Nitrate and Nitrite

The analytical method is able to quantify low levels of nitrite. On the other hand, there is no direct measurement of nitrate at low concentrations in seawater. Therefore, prior to the measurement, nitrate is chemically reduced to nitrite in a column filled with reduced copper on cadmium particles.

#### Reagents

(1) Cadmium particles; (2) add 50 ml of HCl (conc.) to 250 ml of milli-Q (mQ) water; (3) add 250 ml of nitric acid (conc.) to 250 ml of mQ water; (4) add 2 g of copper (II) sulfate pentahydrate to 100 ml of mQ water; (5) add 125 g of ammonium chloride to 500 ml of mQ water, (6) add 25 ml of reagent 5 to 1 l of mQ water; (7) add 5 g of sulfanilamide to HCl solution (50 ml of HCl [conc] is added to 500 ml of mQ water); (8) add 0.5 g of *N*-(1-Naphthyl)ethylenediamine dihydrochloride to 500 ml of mQ water.

#### Nitrate Plus Nitrite

##### Preparation of Cd-Cu Column

1. Add 50 ml of reagent 2 to 50 g of cadmium particles.
2. Replace the reagent 2 with mQ water until the pH is neutral.
3. Add reagent 3. Thereafter, wash with mQ water.
4. Place cadmium particles in a flat layer on the bottom of beaker.
5. Add 250 ml of reagent 4 and wait until the solution is discolored.
6. Remove the supernatant and wash twice with reagent 6.
7. Place glass wool on the lower end of the glass column.
8. Fill the column with the cadmium particles coated with reduced copper.
9. Add 1 l of reagent 6 to the column at a speed of 8–12 ml/min.

##### Reducing of Nitrate

1. Add 100 ml of the sample and 2 ml of reagent 5 to the column.
2. The flow speed is controlled at one drop per second, and 25 ml of eluent is collected.

##### Measurement

1. Add 0.5 ml of reagent 7 to 25 ml of eluent.
2. After 8 min, add 0.5 ml of reagent 8, and measure the absorbance at 543 nm after 20 min.

##### Nitrite

1. Add 1 ml of reagent 5 to 50 ml of the sample.
2. The measurement is performed in the same manner as that for nitrate.

To calculate the concentration of nitrate, subtract the nitrite concentration from that of the total.

### 25.4.2 Phosphate

#### Reagents

(1) Add 140 ml of sulfuric acid (conc.) to 900 ml of mQ water (5 N H<sub>2</sub>SO<sub>4</sub>); (2) add 15 g of ammonium molybdate tetrahydrate to 500 ml of mQ water; (3) add 27 g of L-ascorbic acid to 500 ml of mQ water; (4) add 0.34 g of antimony (III) potassium tartrate to 250 ml of mQ water; (5) mix the reagents (1:2:3:4 = 5:2:2:1).

#### Analysis

1. Add 5 ml of reagent 5 to 50 ml of sample.
2. Measure the absorbance at 885 nm.

### 25.4.3 Silicate

#### Reagents

(1) Add 10 g of ammonium molybdate tetrahydrate to 100 ml of mQ water; (2) add 100 ml of HCl (conc.) to 400 ml of mQ water.

#### Analysis

1. Add 1 ml of reagent 1 and 2 to 20 ml of the sample.
2. After 15 min, measure the absorbance at 430 nm.

---

## 25.5 Dissolved Oxygen (DO)

Marine organisms are strongly sensitive to DO concentrations in seawater. Phase shifts between aerobic and anoxic conditions can lead to drastic changes in marine biota. Oxygen is exchanged between the atmosphere and the ocean and is saturated at the surface. Photosynthesis by phytoplankton supplies oxygen to the photic zone, but heterotrophic consumption prevails in the deeper layers. Therefore, DO concentrations gradually decline with depth. Here, we introduce the Winkler method of measuring DO concentration (Fig. 25.1).

#### Reagents

(1) Add 100 g of magnesium chloride tetrahydrate and 1 ml of HCl (conc.) to 250 ml of mQ water; (2) add 90 g sodium hydroxide to 250 ml of mQ water; after cooling to room temperature (20–25 °C), add 25 g of sodium iodide; (3) add 250 ml of HCl (conc.) to 250 ml of mQ water; (4) add 1 g of starch (soluble) to 100 ml of hot mQ water; (5) add 5 g of sodium thiosulfate to 1 l of mQ water; (6) potassium iodide powder; (7) add 3.567 g of potassium iodate to 1 l of mQ water.



**Fig. 25.1** Procedures for DO analysis. Collection of seawater, precipitation after the addition of reagents 1 and 2, and the digital burette for titration

### Standardization of Sodium Thiosulfate Solution

1. Add reagent 6 (~1 g) to 10 ml of reagent 7. Thereafter, add reagent 3.
2. Titrate with reagent 5. If a digital burette is available, reproducibility would be improved. After the sample becomes a washy color, add 1 ml of reagent 4.
3. Continue to titrate until the color completely disappears.
4. Calculate the factor of sodium thiosulfate ( $f$ ) according to the equation below:

$$f = 50 / a,$$

where  $a$  is the volume of titration.

### Measurement of Sample

1. A silicon tube is connected to a water sampler (e.g., Niskin bottle).
2. The tube end is placed on the bottom of the DO bottle, and the cock of the water sampler is opened.
3. Overflow with seawater (more than twice the volume of the DO bottle).
4. Withdraw the tube while flowing, and close the cap.
5. Open the cap carefully, and add 0.5 ml of reagent 1 and 0.5 ml of reagent 2. The reagents should be injected into the bottom of the DO bottle.
6. Close the cap, and mix well.
7. Leave for 1 h. Thereafter, add 2 ml of reagent 3, and mix well.
8. Pour the sample into a beaker, and start titration with reagent 5.
9. After the sample becomes a washy color, add 1 ml of reagent 4.
10. Continue to titrate until the color completely disappears.

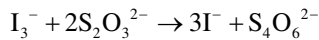
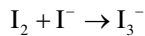
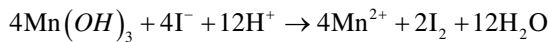
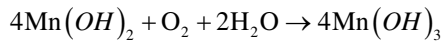
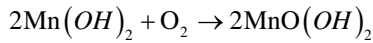
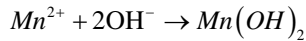
11. Calculate the DO concentration according to the equations below:

$$\text{DO}(\text{ml O}_2 \text{ l}^{-1}) = 5.6 \times a \times 0.02 \times 1000 / (v-1) \times f,$$

$$\text{DO}(\text{mg O}_2 \text{ l}^{-1}) = 8.0 \times a \times 0.02 \times 1000 / (v-1) \times f,$$

where  $a$  is the volume of titration,  $v$  is the volume of the DO bottle, and  $f$  is the factor of sodium thiosulfate.

### Principle of the Winkler Method



## 25.6 Chlorophyll $a$

Chl  $a$  has been widely used as an indicator of phytoplanktonic biomass. Here, we describe the Welshmeyer method, in which Chl  $a$  concentrations are quantified based on fluorescent intensity.

A particulate organic matter sample is collected by filtration. The filter is immersed in 6 ml of N,N-dimethylformamide (DMF), and stored in a freezer ( $-20^\circ\text{C}$ ) for 24 h for Chl  $a$  extraction. The extraction of Chl  $a$  by DMF is relatively simple, because extraction is achieved without grinding and the pigment is stable under dark and cold ( $-25$  to  $5^\circ\text{C}$ ) conditions for several weeks (Suzuki and Ishimaru 1990). However, DMF should be treated carefully, because it is carcinogenic to humans. In the case that extraction is performed by other solvents, such as 90% acetone or methanol, the filter should be ground to enhance the extraction efficiency (Yentsch and Menzel 1963). The fluorescence is measured at excitation and emission wavelengths of 436 and 680 nm, respectively, using a fluorophotometer.

## References

- Carlson, C. A., & Hansell, D. A. (2014). DOM sources, sinks, reactivity, and budgets. In *Biogeochemistry of marine dissolved organic matter* (2nd ed., pp. 65–126). London: Academic Press. <https://doi.org/10.1016/B978-0-12-405940-5.00003-0>
- De La Rocha, C. L. (2007). 6.04—The biological pump. In H. D. Holland & K. K. Turekian (Eds.), *Treatise on geochemistry* (pp. 1–29). Oxford: Pergamon.
- Redfield, A. C. (1934). *On the proportions of organic derivatives in sea water and their relation to the composition of plankton*. Liverpool: University Press of Liverpool.
- Ryther, J. H., & Dunstan, W. M. (1971). Nitrogen, phosphorus, and eutrophication in the coastal marine environment. *Science*, *171*, 1008–1013. <https://doi.org/10.1126/science.171.3975.1008>
- Sharp, J. H. (1997). Marine dissolved organic carbon: Are the older values correct? *Marine Chemistry*, *56*, 265–277. [https://doi.org/10.1016/S0304-4203\(96\)00075-8](https://doi.org/10.1016/S0304-4203(96)00075-8)
- Suzuki, R., & Ishimaru, T. (1990). An improved method for the determination of phytoplankton chlorophyll using N, N-dimethylformamide. *Journal of the Oceanographical Society of Japan*, *46*, 190–194. <https://doi.org/10.1007/BF02125580>
- Yentsch, C. S., & Menzel, D. W. (1963). A method for the determination of phytoplankton chlorophyll and phaeophytin by fluorescence. *Deep Sea Research and Oceanographic Abstracts*, *10*, 221–231. [https://doi.org/10.1016/0011-7471\(63\)90358-9](https://doi.org/10.1016/0011-7471(63)90358-9)
- Yoro, S. C., Panagiotopoulos, C., & Sempéré, R. (1999). Dissolved organic carbon contamination induced by filters and storage bottles. *Water Research*, *33*, 1956–1959. [https://doi.org/10.1016/S0043-1354\(98\)00407-2](https://doi.org/10.1016/S0043-1354(98)00407-2)



Jason M. Hall-Spencer and Koetsu Kon

## Abstract

In the seventeenth century, Hugo Grotius developed the doctrine of the ‘freedom of the seas’, arguing that the ocean bounty was vast enough to share without ownership. However, the human population has trebled since 1950 with much of the recent growth located in coastal regions where we are witnessing a profound transformation of our relationship with the natural world. Over that time fertilizer consumption has increased from 40 to 280 million tonnes a year, quadrupling inputs of nitrogen to the coastal zone. Motor vehicle use is up from 30 million in the 1950s to 750 million vehicles on the road, and international tourism has risen from <1 million international arrivals of people per year to 600 million today. Our use of natural resources is accelerating and this, coupled with poor management, means the planet has entered a phase of mass extinction with widespread biodiversity loss. Within a generation, fishing using fossil fuels has removed large fish from ecosystems and homogenized continental shelf habitats, with extensive damage even on remote seamounts. This chapter sets out the scale of some of the challenges we face in managing the ways in which humans impact the oceans.

---

J. M. Hall-Spencer (✉)

School of Biological and Marine Sciences, University of Plymouth, Plymouth, UK

Shimoda Marine Research Center, University of Tsukuba, Shimoda, Shizuoka, Japan

e-mail: [jason.hall-spencer@plymouth.ac.uk](mailto:jason.hall-spencer@plymouth.ac.uk)

K. Kon

Shimoda Marine Research Center, University of Tsukuba, Shimoda, Shizuoka, Japan

## 26.1 Over Fishing

Marine fisheries have existed since prehistoric times but the advent of smoking and salting in the 1500s started a major increase in exploitation. A global whaling industry followed European exploitation in the 1600s, with increasingly sophisticated methods targeting migratory species such as sperm whales in the 1700 and 1800s. The production of fish meal for use in animal feed started in the 1840s, alongside the preserving of fish in tin cans. By the 1860s steamers began to replace sailing vessels enabling faster moving species to be hunted, such as baleen whales. In 1883 Thomas Huxley stated:

I believe then that the cod fishery, the herring fishery, pilchard fishery, the mackerel fishery and probably all the great sea fisheries are inexhaustible: that is to say that nothing we do seriously affects the number of fish, and any attempt to regulate these fisheries seems consequently from the nature of the case to be useless.

Huxley could not have foreseen the enormous increase in fishing pressure that came with engine-powered vessels. In the 1960s whale catches declined sharply worldwide. Between 1960 and 1975 long-liners, which catch fish such as tuna and marlin, reduced the community biomass of these fish by 80%. In the 1970s cod catches off the Grand Banks of Newfoundland decreased from 800,000 to less than 200,000 tonnes per year. In the 1980s the cod stock collapsed and has never recovered. The global ocean has now lost 90% of its large predatory fish with the extinctions of populations and even species becoming a very real possibility. The United Nations estimates that one-third of the world's fish stocks are overfished (FAO 2018) and much of the fishing industry now relies on invertebrate species like prawns, cuttlefish and scallops rather than fish to provide food, income and employment.

---

## 26.2 Damaging Fishing Methods

Worldwide, diesel-powered trawlers are homogenizing the shelf-break sea-floor (>200 m depth) just as steam-trawlers did on the continental shelf a century ago. Breeding areas used by commercially important species of fish can easily be bulldozed with one passage of a trawl (Clark et al. 2010). Scallop dredging also causes widespread damage to benthic marine habitats and blast fishing is another highly damaging fishing practice, whereby explosives are used to stun or kill schools of fish so that they can be collected easily. The explosions cause extensive destruction to coral reefs. Although outlawed, tens of thousands of fishermen are still involved in this practice in southeast Asia and Africa (Williams et al. 2018). Set nets and pots are much less damaging to seabed habitats, although when lost they may continue to fish, a problem called 'ghost fishing' which is particularly acute for gear made from plastics.

## 26.3 Construction, Dredging and Mining

There has been a rapid spread of wind farms, aquaculture, coastal defences and artificial islands in the past few decades. Megacities such as Tokyo have taken up large areas of coastal habitats through coastal land reclamation. To deal with rising and stormier seas, coastlines have been increasingly ‘hardened’ with artificial coastal defences. This response to climate change and sea-level rise aims to protect a growing coastal population and its property, industry, transport and recreational infrastructure (Firth et al. 2016). We are seeing global biotic homogenization of the coastal environment as species invasions and extinctions increase similarity of marine communities at local, regional and global scales. Ocean sprawl needs to be managed to support human populations and activities and also strengthen ecosystem resilience.

Dredging is widely used to prevent ports and harbours from silting up and this clearly has an impact on the benthos that is being removed, with smothering in the locations where the spoil is dumped. Offshore, humans continue to impact our oceans through the mining of oil and gas reserves, extraction of sand and gravel for construction or land reclamation, and in some cases even the mining of carbonates from tropical coral reefs or coralline algal deposits. Due to increases in the prices of rare metals, locations that were previously unattainable are beginning to be utilized. For example, hydrothermal vents can be rich in metals, including gold, and so recent mining of such deposits has taken place at vents off Papua New Guinea.

---

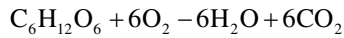
## 26.4 Marine Pollution

Oil spills attract large amounts of media attention, and so they are often considered to be the main source of marine pollution by the general public, and yet they actually only represent a tiny proportion of marine pollution. Land-based discharges represent 80% of marine pollution, followed by atmospheric inputs, maritime transport and deliberate dumping at sea. Wastes can be categorized into five different categories: (1) Biodegradable waste, (2) Fertilizers, (3) Dissipating wastes, (4) Particulates and Debris and (5) Conservative wastes. If non-native organisms are introduced then this is called as biological pollution.

**Biodegradable Waste** is the largest volume of waste that enters the seas. It is subject to bacterial attack by oxidation; this removes  $O_2$  from the seawater and produces organic compounds along with carbon dioxide ( $CO_2$ ), water ( $H_2O$ ) and ammonia ( $NH_3$ ). Sewage is a typical example, agricultural waste or the organic material from paper pulp mills, breweries and slaughterhouses are all biodegradable. Pollution from large oil spills can be deadly to marine life in the short term, for example, by clogging the feathers of seabirds, yet it is eventually broken down by bacteria. To meet the growing demand for protein, fish farms are increasingly being used. These farms are often situated in sheltered waters, where limited seawater exchange allows uneaten fish food and faeces to build up and cause seabed anoxia.



The process of waste biodegradation works as follows: in the first stage aerobic bacteria break down organic molecules producing water and carbon dioxide as per the following equation:



This occurs when there is more than 1.5 mg/l of oxygen in the water. A second stage occurs if oxygen levels fall below this threshold. Then anaerobic bacteria continue the breakdown of the organic molecules, but the end products are hydrogen sulphide ( $\text{H}_2\text{S}$ ), ammonia ( $\text{NH}_3$ ) and methane ( $\text{CH}_4$ ) which are toxic to many organisms.

**Fertilizers** used to improve crop yields on land have had a profound effect on enclosed seas such as the Sea of Japan. Worldwide fertilizer consumption has increased from 40 million tonnes (Mt) per year in 1950 to 280 Mt per year today (Steffen et al. 2018). Inorganic nitrates, phosphates and potassium (NPK fertilizers) wash off agricultural land and enter the sea via rivers and estuaries. This can cause eutrophication, whereby marine algal growth is stimulated by the artificial increase in nutrient availability. On many Asian coastlines ‘green tides’ are becoming an increasing problem, as excess nutrients promote seasonal blooms of *Ulva* spp. that then rot and cause anoxia. Eutrophication also increases the incidence of harmful algal blooms due to toxic dinoflagellates such as *Gymnodinium* spp., the toxins can build up in shellfish and harm people that eat them. When phytoplankton blooms collapse, the algae sink and enhance organic carbon loads in the sediment, the microbial breakdown of which contributes to anoxia and can negatively impact spawning grounds for fish. In Seto Inland Sea, Japan, for example, ca 14 million farmed yellowtail were killed by harmful algal blooms in 1972, and this region still experiences an average of 10 extensive fish kills annually.

**Dissipating Wastes** rapidly lose their damaging properties once they are diluted in seawater with the impact mostly confined to the discharge point. Nuclear power stations need large amounts of water to cool and control the reactors. The impact of the warmer water effluent depends on the temperature of the water and the organisms and habitats that are found in the vicinity. For instance, if the discharge point was onto a tropical coral reef then this would likely kill corals since they live close to their upper thermal limits. Acids and alkalis are another example of dissipating wastes which are quickly neutralized due to seawater being a great buffer and so the impact of these wastes is typically very localized. Some toxic chemicals, such as cyanide which is emitted by metallurgical industries, rapidly dissociate in sea water and so again their impact is localized. Where cyanide is used regularly for fishing it can nevertheless cause widespread problems.

**Particulates and Debris** are often called ‘suspended solids’ in the water management industry. These reduce the amount and wavelengths of light that can penetrate the water column, and so affect primary producers and their production. As high-

lighted in the section 'Construction, dredging and mining', dredging spoil or land-run off has the potential to seriously damage important habitats such as kelp forests, seagrass beds or coral reefs. Human-driven changes in land use and climate have caused more suspended solids to enter the ocean via run-off (especially following intense typhoons). In some regions, such as North Africa and the central USA, this can lead to desertification and the offshore transportation of clouds of iron rich dust which stimulate algal blooms that can be seen from satellites. Open cast mines such as for coal or clay works can also increase the input of water borne and air borne particulate matter into the marine environment, as does the by-products (e.g. fly ash) of coal powered electricity generation. In large amounts, the particles can clog the feeding and gas exchange apparatus of animals and smother organisms. For example, mass coral death was reported from the Shiraho region of Ishigaki Island, Okinawa, Japan in 2001; red clay sedimentation resulted in more than 75% coral death (e.g. Poritidae, Faviidae, *Montipora* spp. and *Heliopora coerulea*) in an area of ca 8 hectares. Larger debris such as underwater cables, oil rig infrastructure or wrecks alter seabed habitats by providing hard substrata for settlement. There is now no part of the world coastline that is not already contaminated with marine plastic, being widespread on the deep-sea floor, especially in canyons off the coasts of cities, and it has been building up floating near the surface of the mid-ocean gyres forming the so-called garbage patches. As well as degrading the aesthetic appeal of our shores it can be harmful to marine life, such as when birds or turtles ingest it. Abandoned plastic or rubber fishing gear is a particular problem as this can entangle marine life, nylon gill nets, for example, are not biodegradable and the animals they entangle and kill act as bait, attracting more scavenging animals to their doom in a process called ghost fishing.

**Conservative Wastes** are not subject to bacterial breakdown and are harmful as they react with organisms. Examples include chemicals that cause endocrine disruption, although now banned Tributyl Tin (TBT) was widely used as a highly effective antifoulant on the hulls of ships and boats. This chemical is persistent and built up in molluscs to cause 'imposex' whereby female gastropods grew penises and were then unable to reproduce. A country-wide study of Japan in 1993 found that 30 gastropod species (of the 38 species of Japanese gastropods surveyed) were affected by imposex due to marine pollution by organotin compounds (Horiguchi et al. 1995). Many heavy metals (Hg, Pb, Cu, Cd, Zn, etc.) are conservative wastes as they are not easily excreted by marine organisms and so they build up in tissues. This can lead to higher concentrations of these heavy metals in organisms high in the food web (termed bioaccumulation), such that some seafoods can become unsafe to eat, such as people being advised not to eat too much swordfish due to dangerously high levels of mercury. Post-mortem studies on large long-lived marine mammals frequently show toxic levels of halogenated hydrocarbons (such as DDT, PCBs and other pesticides), especially in fatty tissues such as blubber. Radioactivity is another example of a conservative waste as the material from power stations or reprocessing plants and atomic testing of nuclear weapons is long lasting and can persist in food

webs. Every human being alive today has the radioactive signal of atomic arms tests in their teeth and bones. In Japan, radioactivity leaked from the Fukushima nuclear power plants, due to the Great East Japan Earthquake of March 11, 2011. Fukushima-derived radionuclides were found in zooplankton and mesopelagic fish off Fukushima in the Northwest Pacific Ocean, although the radiation risks due to these radionuclides was below those generally considered harmful to marine animals and human consumers (Buesseler et al. 2012).

**Biological Pollution** refers to the harm caused by species being introduced outside of their native range. An example of this is the Chinese Mitten Crab which was accidentally introduced from Asia to Europe via ship ballast water, and is now a major pest on the banks of estuaries. Such introductions are often not accidental, some religious festivals celebrate the release of captive life into the wild which can be dangerous for native organisms. When organisms get too big for aquaria the owners may release the organisms into the wild. The release of lionfish into waters off Florida is now considered to be one of the best examples of a marine invasive species causing widespread harm to the environment. The aquaculture industry, in particular, are responsible for the deliberate mass movement of marine organisms globally, such as the Atlantic Salmon which then escaped from farms and colonized nearby rivers in Tasmania, Australia and Washington State, USA. Japanese oysters have been taken from Japan to the Thau lagoon in the Mediterranean, and thereby also carried other species from the Pacific Ocean inside their shells, which can then grow into reproductive adults in the lagoon. Oysters from the Mediterranean are often shipped live to the Atlantic Ocean to ‘green’ them and improve their taste, bringing with them Japanese species of flora and fauna. Conversely, the Mediterranean mussel *Mytilus galloprovincialis* has colonized intertidal rocky shores all over the temperate Japanese coast, sometimes displacing the native mussel species completely. All of these examples contribute towards the homogenization of marine communities. A world concern is the transport of viruses and bacteria that pose a food security risk, as outbreaks can harm wild or farmed stocks, or pose a risk to humans such as the polio virus which can proliferate in waters that are polluted with sewage.

---

## 26.5 Atmospheric Pollutants

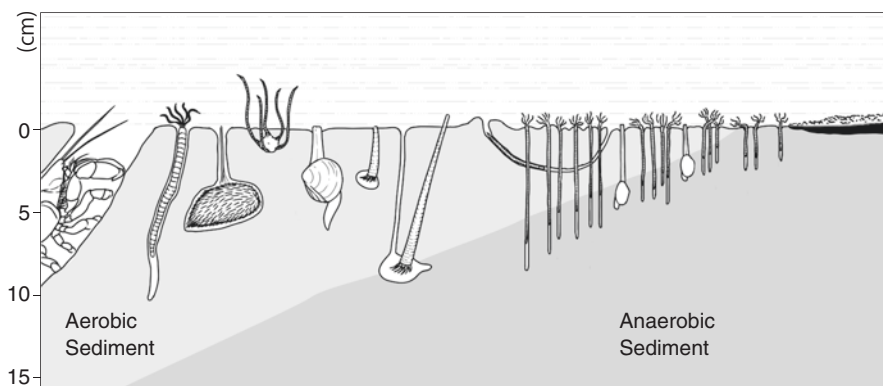
Chlorofluorocarbons (CFCs) were used widely in aerosol cans and fridges but were banned after measurements showed that they were stripping out ozone from the stratosphere. The ‘ozone hole’ in the atmosphere over the southern hemisphere allows more ultraviolet light to penetrate, increasing the incidence of skin cancer in humans, and affecting marine life near the very surface of the ocean such as algae. Most atmospheric pollutants enter the ocean either in rain fall, as particulate fallout, or as gasses that dissolve into the sea, or through a combination of these routes. At its peak, lead was entering the ocean at ca. 400,000 t/year but from 1985 onwards

legislation was introduced worldwide that ensured a shift to unleaded petrol, reducing lead emissions to the ocean.

Nowadays, climate warming gasses ( $\text{CO}_2$ , nitrous oxide and methane) are causing marine heat waves, leading to coral reef and kelp forest damage as well as increased storminess, sea-level rise and coastal squeeze. Since the Industrial Revolution, increasing global average temperature has been linearly correlated with atmospheric  $\text{CO}_2$  concentrations (IPCC 2019). Since the 1970s, the oceans have absorbed over 90% of Earth's heat gain, (Gattuso et al. 2015) and ocean warming can be detected to 1000 m depth. During the past century the global ocean surface temperature has increased by about  $1^\circ\text{C}$  increasing the number of typhoon events by up to 25% (IPCC 2019).

Ocean warming is damaging tropical coral reefs, melting Arctic ice, thawing tundra and causing poleward shifts in the distributions of many marine species. In low-latitude areas warming is causing oxygen depletion and low productivity mid-ocean gyres are expanding in size due to increased thermal stratification which suppresses mixing and so starves the surface waters of the nutrients that underpin food web productivity. (Breitburg et al. 2018) As particulate organic carbon sinks, marine bacteria feed on it, consuming  $\text{O}_2$  and releasing  $\text{CO}_2$ . This results in an oxygen minimum zone (Fig. 26.1). Over the past 50 years, the depth of this hypoxic layer ( $<2\text{ mg O}_2\text{ L}^{-1}$ ) has shoaled from 400 m to 300 m in the Pacific Ocean and the dissolved oxygen content has decreased significantly (Breitburg et al. 2018).

Today we add around  $10\text{ PgC year}^{-1}$  to the atmosphere, around  $9.1\text{ PgC year}^{-1}$  of this is from burning fossil fuels ( $1\text{ PgC} = 1\text{ peta-gram} = 10^{15}\text{ g of carbon}$ ). A quarter of  $\text{CO}_2$  emissions to date have been taken up by the oceans; this equates to every reader of this article—and everyone else on Earth—throwing carbon of the weight of bowling ball into the sea every day. Monitoring of surface seawater off Hawaii, and on both sides of the North Atlantic, clearly shows increases in  $\text{CO}_2$  levels that



**Fig. 26.1** Changes in the fauna and sediments from an aerobic to a polluted anaerobic state due to organic carbon enrichment. The organisms here are drawn based on those typically found during sampling in Japan, adapted from a diagram by Pearson and Rosenberg (1978)

are tracking atmospheric increases. Carbon dioxide forms carbonic acid when it dissolves in water, and has caused a 34% increase in seawater acidity (i.e. the concentration of  $H^+$  ions). This is the fastest rate of chemical ocean change for millions of years (Breitburg et al. 2018).

Ocean acidification increases the amount of carbon available for photosynthesis and so is a resource for primary production, but also lowers the amount of carbonate in the water, so that it can become corrosive to exposed skeletons and shells. The transport of materials across cell membranes is influenced by  $H^+$  concentrations and so this can affect reproduction, behaviour, respiration and growth. Studies at volcanic  $CO_2$  seeps in Japan show that coastal ecosystems are susceptible to ocean acidification as this causes macroalgal dominance, habitat simplification and loss of biodiversity (Hall-Spencer and Harvey 2019). Ocean acidification lowers the resilience of coastal habitats to a cluster of other drivers associated with climate change (global warming, sea-level rise, increased storminess) increasing the risk of marine regime shifts and the loss of critical ecosystem functions and services.

---

## 26.6 Solutions

Our understanding of how to exploit marine resources has moved much faster than our ability to manage them. One of the difficulties facing society when it comes to finding solutions to reduce impacts on the oceans is a communication problem. Many people are unaware of the effects of humans on and beneath the seas leading to the issue of ‘out of sight, out of mind’. Yet the rate of changes in ocean systems is accelerating. Destructive fishing practices, heat waves, pollution, biodiversity loss, spreading low-oxygen ‘dead zones’ and ocean acidification are having synergistic effects across the board—from coastal areas to the open ocean, from the tropics to the poles. Fortunately, there is a rapidly expanding global awareness of both the interconnectedness and the wonder of ocean systems. With this growing awareness comes an empowering sense of stewardship.

Solutions to fixing the worst problems facing ocean governance include creating well managed protected areas, reducing the input of pollutants—including plastics and agricultural fertilizers—and making sharp reductions in greenhouse gas emissions. There are welcome signs that society is beginning to deal with fishing impacts. Public consultations reveal widespread support for networks of seabed regeneration zones that would be off-limits to the most destructive forms of fishing. A network of no-trawl areas is emerging, with (for example) trawling now banned in Hong Kong. The extent of climate change impacts depends on which energy pathway society follows, our ability to reduce other stressors and whether we can assist the rate at which species adapt and migrate to survive.

The phasing out of CFCs and leaded petrol are good examples of the international policy community working effectively to bring about change in the face of scientific evidence. The technology to clean up or prevent all pollution exists, but this comes at a cost. Marine pollution represents a conflict of interests and a balance between (for example) sewage disposal vs amenity and health. In this case, the

Japanese people are willing to pay the taxes needed to keep coastal waters safe for both seafood consumption and swimming. As the human population grows so will tensions between Pollution vs Conservation vs Economics although there can be win-win solutions. Coastal vegetation (algae, seagrasses, mangroves) can prevent acid water run-off, capture and store carbon and raise the pH of coastal waters. Seaweed farming and the gradual restoration of mangroves in areas that have been converted to shrimp farms are ways in which we can help build resilience in coastal ecosystems. Technical means to achieve many of these solutions already exist, although outdated values are holding society back from putting them in place effectively. Overcoming these barriers is core to the fundamental changes needed to achieve a sustainable and equitable future for the generations to come: a future that preserves the natural ecosystems of the Earth that we benefit from and enjoy today.

---

## References

- Breitburg, D., Levin, L. A., Oschlies, A., Grégoire, M., Chavez, F. P., Conley, D. J., et al. (2018). Declining oxygen in the global ocean and coastal waters. *Science*, *359*, eaam7240.
- Buesseler, K. O., Jayne, S. R., Fisher, N. S., Rypina, I. I., Baumann, H., Baumann, Z., et al. (2012). Fukushima-derived radionuclides in the ocean and biota off Japan. *PNAS*, *109*, 5984–5988.
- Clark, M. R., Rowden, A. A., Schlacher, T., Williams, A., Consalvey, M., Stocks, K. I., et al. (2010). The ecology of seamounts: Structure, function and human impacts. *Annual Reviews in Marine Science*, *2*, 253–278.
- Firth, L. B., Knights, A. M., Bridger, D., Evans, A., Mieskowska, N., Moore, P. J., et al. (2016). Ocean sprawl: Challenges and opportunities for biodiversity management in a changing world. *Oceanography and Marine Biology: An Annual Review*, *54*, 189–262.
- FAO. (2018). The state of world fisheries and aquaculture 2018 – meeting the sustainable development goals. Rome. Licence: CC BY-NC-SA 3.0 IGO.
- Gattuso, J.-P., Magnan, A., Billé, R., Cheung, W. W. L., Howes, E. L., Joos, F., et al. (2015). Contrasting futures for ocean and society from different anthropogenic CO<sub>2</sub> emissions scenarios. *Science*, *349*(6243), aac4722.
- IPCC. (2019). Special report on the ocean and cryosphere in a changing climate. [H.- O. Pörtner, D.C. Roberts, V. Masson-Delmotte, P. Zhai, M. Tignor, E. Poloczanska, K. Mintenbeck, M. Nicolai, A. Okem, J. Petzold, B. Rama, N. Weyer (eds.)].
- Hall-Spencer, J. M., & Harvey, B. P. (2019). Ocean acidification impacts on coastal ecosystem services due to habitat degradation. *Emerging Topics in Life Sciences*, *3*, 97–206. <https://doi.org/10.1042/ETLS20180117>
- Horiguchi, T., Shiraishi, H., Shimizu, M., Yamazaki, S., & Morita, M. (1995). Imposex in Japanese gastropods (neogastropoda and mesogastropoda): Effects of tributyltin and triphenyltin from antifouling paints. *Marine Pollution Bulletin*, *31*, 402–405. [https://doi.org/10.1016/0025-326X\(95\)00133-8](https://doi.org/10.1016/0025-326X(95)00133-8)
- Pearson, T. H., & Rosenberg, R. (1978). Macrobenthic succession in relation to organic enrichment and pollution of the marine environment. *Oceanography and Marine Biology: An Annual Review*, *16*, 229–311.
- Steffen, W., Rockström, J., Richardson, K., Lenton, T. M., Folke, C., Liverman, D., et al. (2018). Trajectories of the earth system in the Anthropocene. *PNAS*, *115*, 8252–8259.
- Williams, S. L., Sur, C., Janetski, N., Hollarsmith, J. A., Rapi, S., Barron, L., et al. (2018). Large-scale coral reef rehabilitation after blast fishing in Indonesia. *Restoration Ecology*, *27*(2), 447–456. <https://doi.org/10.1111/rec.12866>



# Survey Techniques in Marine Environmental Sciences

# 27

Shigeki Wada and Yuko Omori

## Abstract

The spatial and temporal variabilities of marine environments indicate the complexity of marine ecosystems. Since the Challenger expedition in the nineteenth century, techniques for surveying environmental factors have rapidly progressed. Recent developments of methods with sensors or other automated facilities have allowed us to reveal the spatiotemporal variations in environmental parameters within a short time. However, the analysis of seawater collected in situ remains effective for understanding environmental conditions in detail. Here, we introduce survey techniques for measuring basic oceanographic parameters, such as temperature, salinity, transparency, and solar irradiance. Becoming skilled on the analytical procedures for these parameters will help us to understand the mechanisms of marine ecosystems and assess environmental change.

## 27.1 Seawater Sampling

Seawater samples should be collected by appropriate water samplers without contamination to obtain accurate biogeochemical parameters in the ocean. Sea surface water (at a depth of 0 m) is sampled using a bucket (Fig. 27.1). Seawater under the sea surface is collected using a water sampling bottle. Niskin bottle (General Oceanics, Miami, Florida, USA or Ocean Test Equipment, City of Fort Lauderdale,

---

S. Wada (✉)

Shimoda Marine Research Center, University of Tsukuba, Shimoda, Shizuoka, Japan  
e-mail: [swadasbm@shimoda.tsukuba.ac.jp](mailto:swadasbm@shimoda.tsukuba.ac.jp)

Y. Omori

Graduate School of Life and Environmental Sciences, University of Tsukuba,  
Tsukuba, Ibaraki, Japan



**Fig. 27.1** Bucket sampling of the sea surface water on a ship



**Fig. 27.2** Niskin bottle

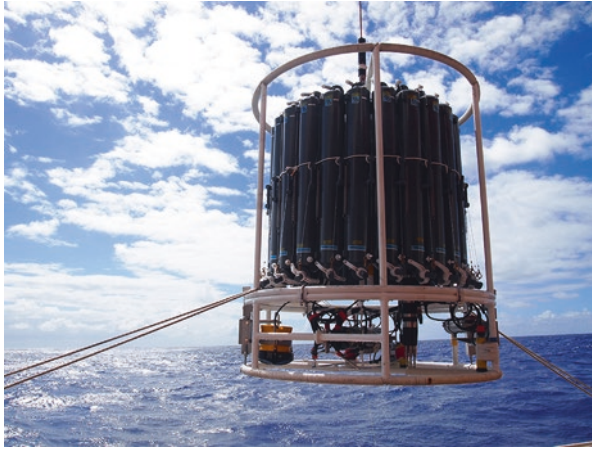
Florida, USA) is widely used as the sampling bottle (Fig. 27.2). For observations in the open ocean, a rosette sampler with 12 or more Niskin bottles (volume: 1.2–30 L) fitted around a frame mounted with a CTD sensor is commonly used (Fig. 27.3; For CTD, see Sect. 27.6). In coastal areas, a Van Dorn water sampler and Kitahara's water bottle can also be used for water sampling.

The procedures of sampling sea surface water are as follows (Nakano et al. 2018):

1. Clean a bucket with tap water at least three times.
2. After fixing the handle to a rope, toss the bucket over the side of the ship or quay (Fig. 27.1). The sampling location should be away from the drain of the ship.
3. Pull the bucket up and discard the water away from the sampling point. Repeat three times to rinse the bucket with sample water.
4. Collect a water sample.

The procedures for sampling with a Niskin bottle are as follows (Nakano et al. 2018):





**Fig. 27.3** Rosette sampler with CTD

1. Before the observation, wash the inside and outside of a Niskin bottle using neutral detergent (e.g., 1% solution of S-CLEAN WO-23, Sasaki Chemical Co., Ltd., Kyoto, Japan). Clean and rinse with freshwater until the detergent is completely removed from the Niskin bottle. The O-rings at the top and bottom of the Niskin bottle and at the air vent should be checked.
2. Close the petcock and air vent before sampling.
3. Attach the Niskin bottle to a wire or rope with a weight.
4. Open the top and bottom of the Niskin bottle.
5. Lower the Niskin bottle to the desired depth, then maintain it at this depth for about 1 min.
6. Throw a weighted messenger to close the Niskin bottle and trap the water in the bottle.
7. After the Niskin bottle is pulled up onto the deck, check for its leaks. At first, push in the petcock and check whether there are leaks. Then, pull the petcock and open the air vent.
8. If there is no leak, push in the petcock and collect the water sample from the Niskin bottle (Fig. 27.4).

---

## 27.2 Filtration

Seawater contains organic and inorganic compounds with a wide range of sizes, from zooplankton and phytoplankton to colloids and dissolved organic matter. It is possible to separate and collect fractions of these compounds by size. We should select appropriate filters to collect the desired objects:

- To collect phytoplankton on a filter, use a glass-fiber filter with pore size  $0.7 \mu\text{m}$  (e.g., Whatman Grade GF/F filter, GE healthcare Life Sciences, Chicago, Illinois, USA).



**Fig. 27.4** Sampling seawater from the rosette sampler

- To collect bacteria on filters, use a membrane filter with pore size  $0.2\ \mu\text{m}$  (e.g., Supor membrane filter, Pall Corporation, Port Washington, New York, USA).
- To separate particulate organic matter from dissolved organic matter in filtrate, use a glass-fiber filter and membrane filter with pore size  $0.2\text{--}0.7\ \mu\text{m}$ .

---

### 27.3 Procedures of Filtration for the Chlorophyll *a* Measurement

1. Collected water samples from bucket or water samplers are transferred into appropriate bottles rinsed with water samples. The samples should be stored in the dark and filtered as soon as possible.
2. Place a glass-fiber filter (e.g., 25 mm Whatman Grade GF/F filter) on a filter holder and place a funnel on the filter.
3. Measure the volume of the water sample and pour the sample into the funnel.
4. Apply a gentle vacuum at less than 120 mm Hg. After the entire sample passes through the filter, rinse the funnel with filtered seawater to collect all particles.
5. Collect the filter and store it in a deep freezer ( $-80\ ^\circ\text{C}$ ) until analysis.
6. Procedure for extraction from the filter and analytical method are described in chapter 25.

---

### 27.4 Water Temperature

Water temperature is one of the most essential physical properties, along with pressure and salinity. The spatial and temporal distributions of water temperature allow us to understand water mass structure and thermal dynamics in the ocean. Water temperature ( $^\circ\text{C}$ ) can be measured by glass thermometer and electric thermometer.

At present, the electric thermometer (temperature sensor) is widely used to measure temperature within the water column (see the Sect. 27.6).

For the measurement of sea surface temperature:

1. Collect sea surface water following the method of “sampling of sea surface water.”
2. Measure water temperature with a thermometer in a shaded area, after leaving it to stabilize (about 1 min). The water in the bucket should be continuously stirred.

---

## 27.5 Salinity

Salinity is the measure of dissolved salt content in water. Since 1978, oceanographers have used the Practical Salinity Scale (PSS-78), which defines salinity as the ratio of the electrical conductivity of a seawater sample to the conductivity of a potassium chloride standard solution in which the mass fraction of potassium chloride is  $32.4356 \times 10^{-3}$  (UNESCO 1981). Practical salinity is not expressed in SI units.

Seawater samples for salinity measurements are usually collected in 120–250 ml glass bottles with screw caps to prevent evaporation. The sampling procedures are as follows (Kawano 2010):

1. Rinse a sampling bottle and its cap three times with sample water, and allow the water to overflow the bottle for few seconds. Discard excess water until the water is level with the shoulder of the bottle.
2. Screw the cap onto the bottle tightly. Then, rinse the sealed bottle with freshwater and dry to prevent the formation of salt crystals around the cap.
3. Store the bottle upside down in a carrying case. The sample should be stored for at least 12 h in the laboratory where the salinity is to be measured, for temperature equilibration.

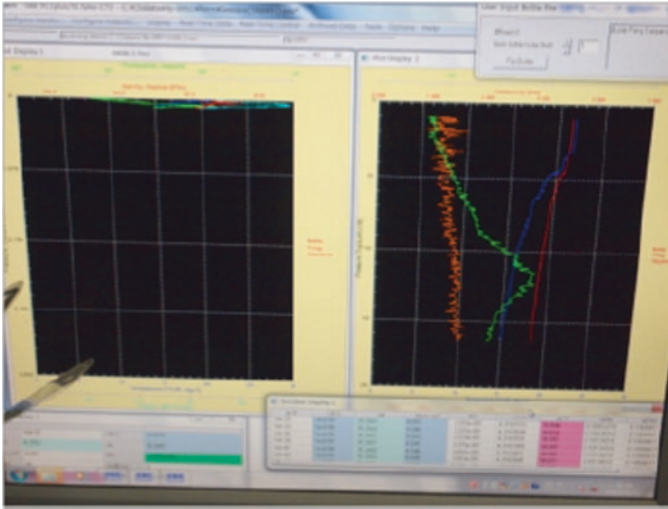
An Autosal Laboratory Salinometer (Guildline Instruments, Ltd., Smiths Falls, Canada) is used for the measurement of seawater salinity. The measurement procedure is described in the device’s technical manual.

---

## 27.6 CTD

The CTD sensor is the most useful instrument to continuously measure physical variables in the water column. It obtains data on conductivity and pressure to determine salinity and depth, respectively.

The CTD instrument consists of a main housing containing the acquisition electronics and telemetry circuitry; conductivity, temperature, and pressure sensors; and pump to provide a flow of seawater to the conductivity sensor. For observations in the open ocean, an SBE 9plus CTD (Sea-Bird Scientific, Bellevue, Washington, USA) is widely used. Connecting to a deck unit (SBE 11plus, Sea-Bird Scientific,



**Fig. 27.5** Real-time measurement with CTD

Bellevue, Washington, USA) via conducting cable (from which it is supplied power), this CTD provides real-time and high-resolution profiles of the three parameters (Fig. 27.5). For coastal observations, self-recording CTD instruments, such as the SBE 19plus (Sea-Bird Scientific, Bellevue, Washington, USA) or RINKO-profiler (JFE Advantech Co., Ltd., Nishinomiya, Japan), can be applied.

The conductivity, temperature, and pressure sensors employed in CTDs require accurate calibration before observations, because the electrical sensors can drift. Accuracy standards for these sensors are as follows: 0.002 °C (ITS-90) for temperature, 0.002 (PSS-78) for salinity, and 3 dbar for pressure (McTaggart et al. 2010). To obtain highly accurate measurement, it is valid to compare the CTD with calibrated sensors and independent measurements using thermometers and salinometers.

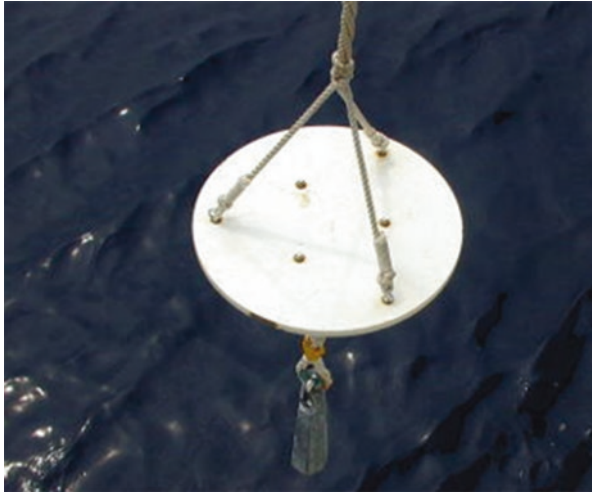
---

## 27.7 Transparency (Secchi Depth)

The use of a Secchi disk is one of the most traditional methods to measure the transparency of water (Fig. 27.6). A white 30 cm diameter disc is used for marine environments, and a modified one with black and white color is used for freshwater.

1. Lower the disc to the depth at which it becomes invisible.
2. Repeatedly raise and lower the rope to carefully determine the Secchi depth.

All measurements should be performed on the shaded side of the boat to avoid the effect of surface reflection. Even if the rope is obliquely lowered, the length of the rope underwater is logged. We should not take into account the angle to evaluate the Secchi depth.



**Fig. 27.6** Secchi disc

---

## 27.8 Evaluation of Water Color with the Forel-Ule Scale

Seawater color is variable among oceanic regions, and the Forel-Ule (FU) scale can be used to evaluate the color of a body of water. Using the FU scale, it is possible to quantitatively categorize the water color into 21 levels.

1. Submerge the Secchi disc at half of the Secchi depth.
2. Read the color on the Secchi disc in the water, and the number of the most similar level on the FU scale is logged.

The reason why we use the Secchi disc together is to enhance the color of seawater, and make it easier to compare it to the scale (Wernand 2011; Pitarch 2017). To remove the effect of sun glare, the use of a black umbrella is also recommended.

---

## 27.9 Photosynthetically Active Radiation and Photon Flux

Solar radiation in marine environments is the primary driver of photosynthesis. Since photosynthetic organisms are able to utilize solar radiation with a wavelength of 400–700 nm, this spectral region of solar radiation is defined as photosynthetically active radiation (PAR). The energy per photon is variable among the wavelengths, but the photosynthetic processes mainly depend on the number of photons. Therefore, PAR is quantitatively expressed as the number of photons per unit area and time ( $\text{mol m}^{-2} \text{s}^{-1}$ ). There are several types of measurement for PAR: scalar, upwelling ( $E_u$ ), and downwelling ( $E_d$ ) irradiances. When we are interested in the number of photons received by phytoplankton, measuring the scalar irradiance with

a spherical sensor ( $4\pi$  sensor) is preferable, because phytoplanktonic cells would receive irradiance from every direction.

Since shading by boat leads to underestimation, the measurement of photon flux should be performed on the side of the boat in the sun. In the case of a large research boat, measurement is sometimes carried out some distance from the side of the boat. Surveys in a cloudy weather would cause fluctuations in solar radiation. In order to calculate the diffuse attenuation coefficient of PAR ( $K_d$ ), which is one of the best parameters to characterize the photo-environment related to photosynthesis, the deployment of a reference sensor on deck or at a fixed depth are preferable.

In general,  $E_d$  is exponentially attenuated, and  $K_d$  is calculated as below:

$$E_z = E_0 * e^{-K_d * Z},$$

where  $E_0$  and  $E_z$  are the  $E_d$  values at the surface and at a certain depth ( $Z$  m), respectively.

There is an empirical equation to convert the Secchi depth to  $K_d$  ( $K_d = 1.44/\text{Secchi depth}$ ) (Poole and Atkins 1929). However, the application of this equation would be difficult in environments with high turbidity (Koenings and Edmundson 1991).

---

## References

- Kawano, T. (2010). Method for salinity (conductivity ratio) measurement. *GO-SHIP repeat hydrography manual: A collection of expert reports and guidelines*. IOCCP Report No 14, ICPO Publication Series No. 134, version 1.
- Koenings, J. P., & Edmundson, J. A. (1991). Secchi disk and photometer estimates of light regimes in Alaskan lakes: Effects of yellow color and turbidity. *Limnology and Oceanography*, 36, 91–105. <https://doi.org/10.4319/lo.1991.36.1.0091>
- McTaggart, K. E., Johnson, G. C., Johnson, M. C., Delahoyde, F. M., & Swift, J. H. (2010). Notes On CTD/O2 data acquisition and processing using sea-bird hardware and software (AS available), *GO-SHIP repeat hydrography manual: A collection of expert reports and guidelines* (IOCCP Rep. No. 14; ICPO Publication Series Number 134). Available online at: <http://www.go-ship.org/HydroMan.html>.
- Nakano, T., Obata, H., Katayama, K., Satoshi, O., & Matsunaga, H. (2018). *Water sampling*. Tokyo: The Oceanographic Society of Japan.
- Pitarch, J. (2017). Biases in ocean color over a Secchi disk. *Optics Express*, 25, A1124. <https://doi.org/10.1364/OE.25.0A1124>
- Poole, H. H., & Atkins, W. R. G. (1929). Photo-electric measurements of submarine illumination throughout the year. *Journal of the Marine Biological Association of the United Kingdom*, 16, 297–324. <https://doi.org/10.1017/S0025315400029829>
- UNESCO. (1981). *Tenth report of the Joint Panel on Oceanographic Tables and Standards*. UNESCO technical papers in marine sciences, 36, 25.
- Wernand, M. R. (2011). *Poseidon's paintbox: Historical archives of ocean colour in global-change perspective*. Retrieved May 12, 2019, from <http://dspace.library.uu.nl/handle/1874/212589>



# Experimental Design in Marine Environmental Sciences

# 28

Sylvain Agostini, Ben P. Harvey, and Shigeki Wada

## Abstract

Environmental science and ecology are complex fields of study where research requires multiple scales (spatial and temporal) and levels (organismal, species, populations, ecosystems) to be considered. The aim of these fields of study is to understand or explain the distribution and abundances of organisms, including their interactions with the surrounding environment. The principal approach by a researcher will be to design an experiment where one or more parameters (of interest) are altered, while the other parameters remain at natural conditions. A well-designed experiment should allow the researcher to determine the parameters responsible for controlling the abundance and distribution of the species being studied. The design of experiments, including the correct use of controls and replicates, is therefore of the utmost importance, as badly designed experiments can lead to incorrect conclusions. Experimental design broadly incorporates the hypotheses being tested, parameters to be controlled, responses to be measured, methods of carrying out the experiment, statistical analysis that will be used, and interpretation of the results. The scope of the experiment will dictate the considerations required for the experimental design. For example, for physiological studies, a highly controlled isolated environment is often required, and these will often be conducted in small-scale aquariums or microcosms. For population- or community-level responses studies, mesocosms or manipulations in the field can be used. In this chapter, we will highlight the main experimental design considerations required for aquarium- and microcosm-based manipulative experiments, with some additional points highlighted about larger-scale mesocosm and field-based experiments. Given the large scope, statistical analysis will not be covered here.

---

S. Agostini (✉) · B. P. Harvey · S. Wada  
Shimoda Marine Research Center, University of Tsukuba, Shimoda, Shizuoka, Japan  
e-mail: [Agostini.sylvain@shimoda.tsukuba.ac.jp](mailto:Agostini.sylvain@shimoda.tsukuba.ac.jp)

## 28.1 Designing Experiments

### 28.1.1 The Concept of Manipulative Experiments

Experiments in environmental sciences can be classified as either “mensurative” or “manipulative.” *Mensurative* experiments are considered an observational approach, where the experimenter does not manipulate the environment in which the experiment is conducted. An example of a *mensurative* experiment would be testing the effects of depth on the growth of an algae. In such a case, the experiment would likely be placing algae specimens at a few different depths and measuring their growth. While such an experimental question may seem simplistic, such experiments still require a well-thought-out experimental design. For example, if half of the algae specimens are placed in one location at a certain depth and the other half at another location at another depth, the comparison of the growth rates will not be between the two different depths but instead between two specific locations (as it is highly unlikely that depth is the only parameter that differs between these two locations). Thus, if one is interested in the effects of depth, then several locations (replicates) along the same depth should be used. Each of these locations being chosen should be considered independent of each other; however, the exact distance between the different locations (replicates) is highly subjective (and should be carefully chosen by the experimenter).

**Manipulative** experiments are associated with a stronger control of the environment by the experimenter to compare the response of the study organisms to different treatments (environmental conditions). In such experiments, the experimental design, including the choice of control, definition of the experimental unit, and randomization of the experimental units across treatments, is fundamental to inferring the causality of the treatment. Microcosm experiments are most often *manipulative* experiments, where the environmental conditions (the conditions in the aquariums) are strongly controlled by the experimenter.

After completing the experiment, the experimenter will aim to interpret their data in order to test their hypothesis and make a conclusion about the findings. In order to have the greatest confidence in the conclusion that is made from the data obtained during the experiment, one needs to control for two type of errors: reaching a wrong conclusion (significant difference is found in the study while there is none in the underlying population, termed a type I error) and not identifying a significant effect (no significant difference is found in the study while there is a real effect of the treatment in the underlying population, termed a type II error). Reaching a wrong conclusion is often down to a poorly designed experiment, and therefore can be mitigated with a well-thought-out research design. Where a significant effect is not found (but should have been), increasing the number of replicates is one potential approach for increasing the chance of detecting the effect of the treatment. When determining the number of replicates that is needed, the simple “the more the



better” approach is suitable, but should be carefully balanced with limitations of time, resources, and space.

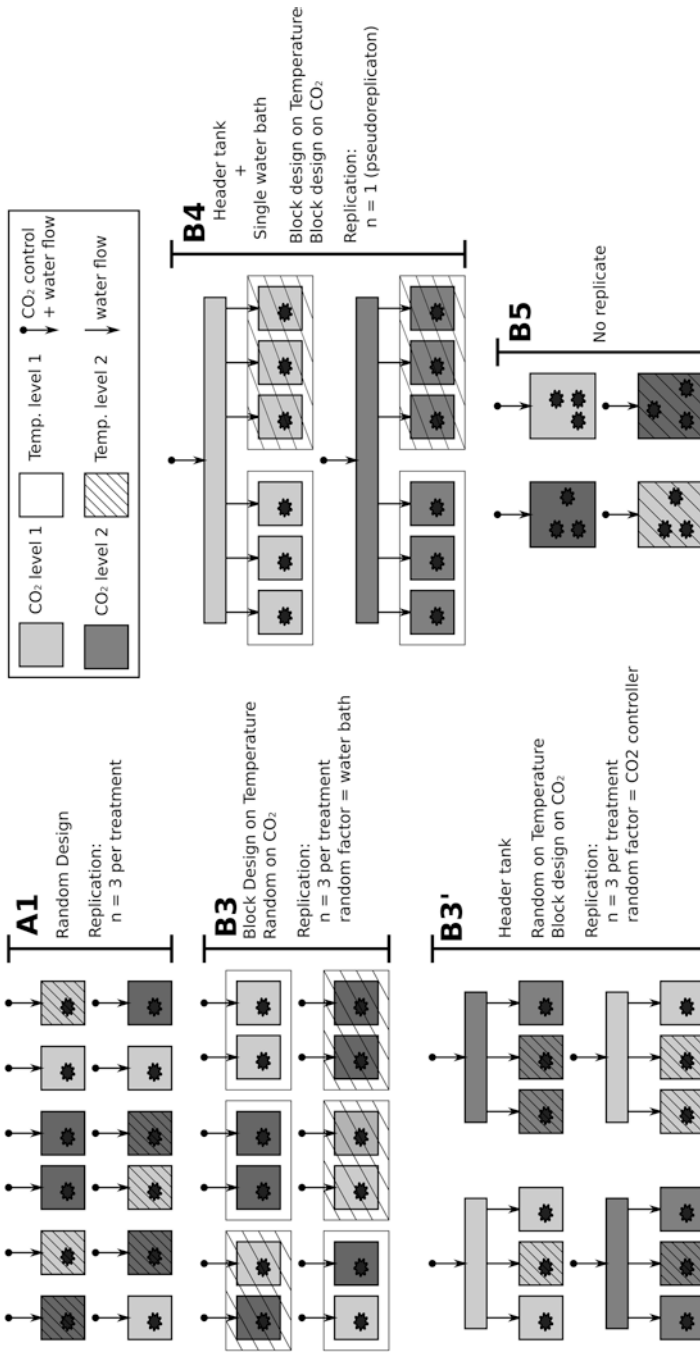
### 28.1.2 True Replication and How to Avoid Pseudoreplication

One of the most fundamental concepts of experimental design (which is often neglected) is *true* replication. Using the example of a microcosm laboratory experiment where two treatments are tested (e.g., temperature and CO<sub>2</sub> concentrations), an acceptable design (classified as A) and “bad” designs (classified as B) are shown in Fig. 28.1 (Hurlbert 1984). First of all, the experimental unit should always be the unit on which you apply the treatment; in our example it would be where you control the temperature (water bath, heaters, etc.) and the CO<sub>2</sub> (pH-stat, CO<sub>2</sub> controller, etc.). In the optimal design (A1), both treatments (temperature and CO<sub>2</sub>) are individually and independently controlled in all experimental units (microcosms), and the microcosms are randomly placed on the bench. With such a design, conclusions (and inference in statistical analysis, e.g., two-way analysis of variance) can be drawn for both treatments.

However, due to budget, space, time, and other constraints, this perfect design is not always possible. B3 and B3’ are examples of designs to be avoided, but where a conclusion on the effect of one treatment, CO<sub>2</sub> in B3 and temperature in B3’, can still be reached. In the case of B3, because there are at least three water baths, the effect of the temperature may still be tested using mixed model statistical analysis. However, in the case of B3’, because there are only two header tanks for each CO<sub>2</sub> treatment, statistical inference should not be used. This does not mean that one cannot draw a conclusion on the effect of CO<sub>2</sub>; a clear difference may still be shown using adequate figures, but this difference cannot be formally tested. Finally, B4 and B5 designs should be especially avoided, as they offer no replication. Confounding factors (sedimentation, algal growth, contamination, etc.) may be lesser in the B4 design, as each organism is individually stored in a separate aquarium; however, the treatments themselves are not replicated and thus formal statistical tests are not possible. The B5 design lacks any replication as multiple organisms in the same aquarium cannot be counted as replicates. During a field course, badly replicated design experiments may be conducted due to diverse limitations, but the caveats of each design should be well understood. Caveats in experimental designs are common; these should be clearly shown by detailing the experimental setup and not trying to conduct “convoluted” statistical analysis to hide them.

### 28.1.3 Choosing Levels of Experimental Treatments

Typically, the effects of the factors, here temperature and CO<sub>2</sub> concentration, are compared to control conditions, which here would be the present conditions in temperature and CO<sub>2</sub>, at the local site. Care should be taken to use realistic control conditions for the specific location from where the organisms were sampled and, if



**Fig. 28.1** Examples of “acceptable (A)” and “bad (B)” experimental designs for a microcosm experiment on the effect of ocean warming and ocean acidification

available, future conditions taken from local prediction models. While it seems obvious that the temperature range is specific to the location, CO<sub>2</sub> in seawater is also variable depending on location. For example, pCO<sub>2</sub> values of 300 ppm or less are common on the Pacific coast of Japan; therefore, using a control value of 400 ppm (the present global atmospheric average) would represent an elevated concentration for organisms in this region. Future increases in temperature are also not homogeneous around the globe and across oceans depths, with some areas warming faster than others (surface vs. deep ocean). If our only goal is to understand the response of the organism to future conditions, the experimental design can be simplified and only the combined effect of elevated temperature and CO<sub>2</sub> could be tested, allowing for greater replications of the two (control and elevated) remaining treatments. Finally, different levels of elevation corresponding to different future dates (2050, 2100, etc.) or different greenhouse gas emission scenarios (RCP3, RCP8.5, etc.) can be tested if the experimental design does not suffer from it (IPCC 2013).

### 28.1.4 Considering the Experimental Duration

The duration of the experiment is also an important factor in interpreting the response observed. The suitable duration will depend on the hypothesis to be tested and the organisms used (e.g., fast growing and reproducing plankton vs. slow growing corals) and should be balanced with the feasibility of the experiment. Climate change and ocean acidification have been the focus of many investigations in the last few decades because of the need to establish data to predict how ecosystems will change. However, these changes occur over a timescale of decades or centuries. The organisms are therefore exposed to chronic stress: stress that occurs constantly over a long period of time. In comparison, most laboratory-based microcosm experiments are limited in time. Sudden changes in environmental conditions, such as the one during an experiment, constitute an acute stress for the organisms. It is not technically feasible to conduct experiments over centuries. Long-term experiments, over a month or more, are closer to reproducing chronic stress, and experiments on fast-reproducing species could include multiple generations. We should accept the fact that the experiments do not exactly reproduce the future ecosystems, as there is little chance to observe adaptation or acclimation in such experiments. However, it is important to limit the effect of acute stresses that are not related to the treatment effect to be tested or not realistic. Acute and confounding stresses due to the laboratory conditions can be mitigated by allowing a period of acclimation for the organisms to adjust to the “new” laboratory conditions (light, organism manipulation, etc.). Similarly, a gradual change in the environmental conditions (e.g., a maximum increase in temperature of 1 °C per day) also limits the acute stress response of the organisms.

## 28.2 Example of a Microcosm Experiment: The Effects of Ocean Warming and Ocean Acidification on Hermatypic Corals

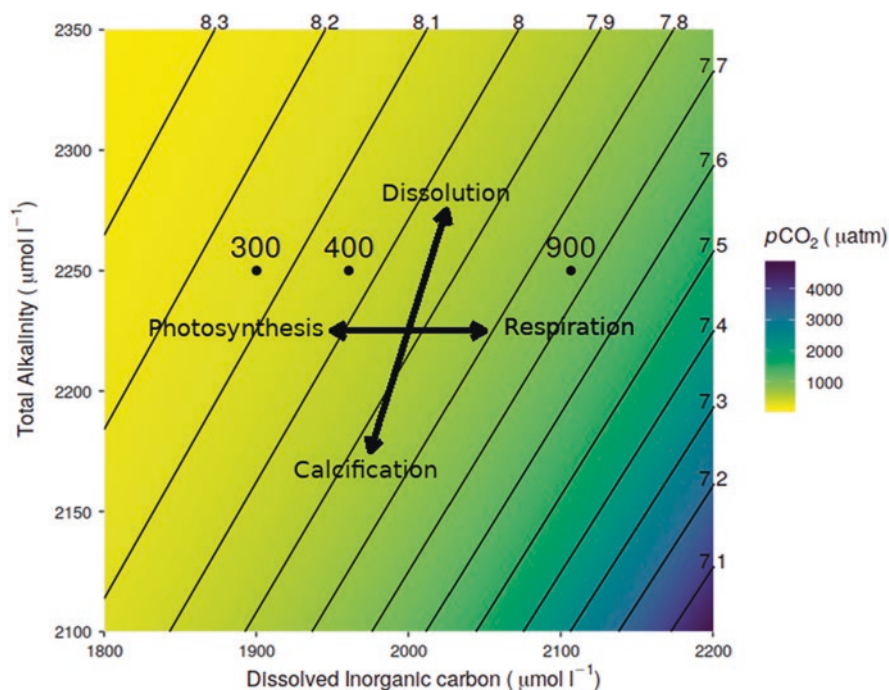
### 28.2.1 Preparation of the Organisms

Organisms are sampled in the field using the appropriate tools and permits, which may be available at the marine station. Permits are especially important in the case of sampling corals, as they are classified as endangered species in most countries. Corals can be sampled using a chisel and hammer (for encrusting or massive forms) or heavy-duty scissors (for branching forms). The fragments can then be sub-fragmented later in the laboratory into suitably sized fragments. In the case that a limited number of colonies and multiple fragments of the same colonies are used, these should be randomly (or evenly) distributed among treatments. The fragments should be allowed to recover from sampling over a period of a month or until lesions are completely recovered. The recovery of corals is preferably performed in a flow-through seawater aquarium.

### 28.2.2 Manipulation of the Microcosm Environment

To maximize the inference on the effects of different treatments, conditions among the aquariums within the same treatments should be as similar as possible. Temperatures can easily be regulated using household aquarium heaters and coolers, but the power of the heater (or cooler) and the accuracy of the controller should be considered. It is surprisingly difficult to control temperature in a flow-through aquarium, especially if they are not directly heated but are placed in a water bath. The size and shape of the aquarium and the flow rate of the water input will dictate the power of the temperature controlling device to use and the variability of the temperature in the experimental unit.

Carbon dioxide in the atmosphere will dissolve in seawater and equilibrate with the carbonate species present following the Eqs. (28.1)–(28.4). The sum of  $\text{CO}_2$ ,  $\text{H}_2\text{CO}_3$ ,  $\text{HCO}_3^-$ , and  $\text{CO}_3^{2-}$  is referred as the “total dissolved inorganic carbon” (DIC). An increase in  $\text{CO}_2$  will lead to increases in the DIC and  $\text{H}^+$  concentration; thus, decreases in the pH and carbonate ( $\text{CO}_3^{2-}$ ) concentration will be seen. Because the increase in DIC (carbonates) is accompanied by an increase in  $\text{H}^+$ , the total alkalinity (TA) of the seawater remains constant (Fig. 28.2). This is especially important to consider, as for some organisms, a change in DIC may be as important as a change in pH or carbonate concentration. For example, some photosynthetic organisms may actually benefit from an elevation in the DIC. Therefore, it is recommended to directly increase  $\text{CO}_2$  through the bubbling of  $\text{CO}_2$  gas (or a mixture of  $\text{CO}_2$  and air).  $\text{CO}_2$  bubbling may be controlled by a  $\text{CO}_2$  controller or through the measurement of pH. Thus, if two of the parameters among  $p\text{CO}_2$ , DIC, TA, and pH are known, the other two can be calculated for a given temperature and salinity (see Dickson DOE and the CO2SYS software).



**Fig. 28.2** Plot showing the changes in total alkalinity (TA), dissolved inorganic carbon (DIC), and pH at 300, 400, and 900  $\mu\text{atm}$   $\text{CO}_2$  and how they are affected by metabolic and abiotic processes: photosynthesis vs. respiration, and calcification vs. dissolution



### 28.2.3 Measurement of Metabolic Activities

The measured responses during an experiment will depend on the hypothesis tested and the organism type (fauna, flora, etc.). Growth is of most interest, but it generally requires a long timescale to assess. Metabolic rates, such as photosynthesis, respiration, calcification, and others, can generally be measured in a short time and can give insights into how the organism performs under the tested environmental conditions. Other physiological processes or biomarkers can also be measured to evaluate the physiological state; however, they are outside the scope of this textbook. Recently omics tools, especially transcriptomics and proteomics, are starting to be widely used in the field of ecophysiology.

### 28.2.3.1 Photosynthesis and Respiration

Photosynthesis and respiration can be described as reverse processes, as the first produces organic matter (living tissue) from inorganic matter and the latter remineralizes organic matter. These two processes can be measured using similar tools. The most straightforward measurement method is to measure the change in dissolved oxygen or dissolved inorganic carbon over the course of an incubation. For photosynthesis, this would be measured under light, while for respiration, it would be measured under dark conditions for photosynthetic organisms. Photosynthesis leads to an increase in dissolved oxygen and a decrease in dissolved inorganic carbon, and respiration leads to a decrease in dissolved oxygen and an increase in dissolved inorganic carbon (Eq. 28.5; Fig. 28.2). Several precautions should be taken during incubation. Gas exchange (air–water) should be limited. A closed vessel can be used, but a vessel with a low surface area:volume ratio is often suitable. Intense mixing of the incubation water and a high concentration of oxygen or CO<sub>2</sub> can also lead to non-negligible gas exchanges. Sufficient water movement should be provided to ensure that no limitation occurs due to the diffusion rate around the organisms. Magnetic stirrers or submersible pumps are convenient, but the mixing rates should not be too intense as to not lead to rapid gas exchange in the case of open vessels. Final concentrations should not be too high or too low. For example, in the case of photosynthesis, an incubation that is too lengthy or a vessel that is too small for the organism could lead to a supersaturation of oxygen and depletion of inorganic carbon and/or nutrients, which would in turn strongly limit the photosynthetic rate.

The accurate measurement of photosynthesis and respiration relies on an accurate measurement of the concentration in either dissolved oxygen or dissolved organic carbon. Multimeters are available, and can give accurate measurements of dissolved oxygen, pH, temperature, and salinity, when the methods and their limitations are well understood and the maintenance and calibration of the material used is adequate. Dissolved oxygen can be measured by either the Winkler method (see Sect. 6.4) or more conveniently (but with less accuracy) by using oxygen sensors. Two types of oxygen probes are available commercially. Clark-type electrodes are based on the diffusion of oxygen through a membrane and the reduction of oxygen by a platinum cathode. This type of electrode offers a rapid response and accurate measurements; however, it consumes oxygen (which could become a problem if very low incubation volumes are used), and requires thorough maintenance and replacement of the membrane and water movement around the electrodes (without this, the oxygen would be depleted at the proximity of the membrane). Recently, a new type of sensor has been made available. These sensors, called optodes, rely on the quenching of fluorescence in the presence of oxygen. Compared to Clark-type electrodes, optodes are advantageous in that they require less maintenance, do not consume oxygen, and are not adversely affected by stirring or other chemicals. However, they are often more expensive and have a slower response time. The calibration of probes can be performed against air, oxygen-saturated water, and zero-oxygen water. Seawater, or a solution of similar salinity, can be used, as salinity has a strong effect on oxygen concentration and the reading given by the electrodes.

Most modern meters allow for automatic salinity correction, in this case, distilled water can be used instead of seawater, and the salinity of seawater where the measurements are made, needs to be entered into the meter (check the DO meter instructions to find the most suitable calibration method for your meter). An oxygen-saturated solution is obtained by bubbling air into the water for 30 min or more; oxygen will dissolve into the water to reach 100% saturation, which is equivalent to an oxygen concentration that is determined by salinity, temperature, and atmospheric pressure (this value is available in tables (IOC, SCOR, IAPSO 2010) or it can be automatically calculated by the oxygen meter). Zero-oxygen solution can be obtained by dissolving sodium sulfite ( $\text{Na}_2\text{SO}_3$ ) at a final concentration of more than  $1 \text{ g l}^{-1}$ . Sodium sulfite will rapidly consume all of the oxygen in the water. The solution should be made just before measurement. Cobalt chloride ( $\text{CoCl}_2$ ,  $100 \text{ mg l}^{-1}$ ) can be added to accelerate the reaction and stabilize the solution.

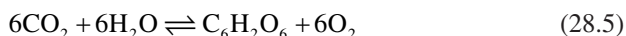
In the case that DIC concentrations are to be used for calculation, the accurate measurement of DIC is required. The most accurate method is by coulometry, but this requires expensive equipment and good technical skill. DIC can also be calculated using pH, TA, temperature, and salinity. The concept of TA measurement is explained in the following section. Salinity can be measured using a salinometer, titration of chloride, or conductivity. The two first methods are time consuming and require equipment and skills often not available during a field course. However, an accurate measurement of salinity can be determined by measuring the conductivity of the seawater. The measurement of pH in seawater requires precaution. Two methods are available: colorimetry, which uses the accurate determination of the absorbance of a pH indicator; or potentiometry, which uses a pH electrode and a potentiometer. Seawater is a solution with a high ionic force (salinity) and complex composition. Typical pH buffers for calibration of the pH electrodes are often not considered adequate for precise measurements. Different pH scales and definitions, and specific buffers for calibration, have been defined. In oceanography, the total scale is considered the most suitable as it includes the presence of sulfuric acid in addition to free hydrogen ions. While calibration buffers can be obtained from the Dickson Laboratory at Scripps Institute of Oceanography in the United States, it may be difficult to obtain them in the context of a field course. Commercially available buffers, referred to as National Bureau of Standards (NBS) (or National Institute of Standards and Technology [NIST]) buffers, are most often used, and the pH is therefore measured on the NBS scale, the commonly used pH scale. In such cases, to obtain a reasonably accurate measurement, it is very important to wait a long time (several minutes) for stabilization of the electrode when the medium is changed; for example, the measurement of seawater pH after calibration in pH NBS buffers. Calibration requires a minimum of two buffers: pH 7, corresponding to a signal of 0 mV, and pH 4 or 10, which gives readings of around  $-150$  or  $150 \text{ mV}$ , respectively. The function of the electrode can be checked by calculating the slope of its response in mV and comparing it with the Nernst equation. Once all four parameters are measured, the DIC is calculated (for example, using CO2SYS; Pierrot et al. 2006) and the change in DIC during the course of the experiment can be determined. The change in DIC will be equivalent to the photosynthesis or

respiration rate. Care should be taken when measuring such rates with calcifying organisms, as calcification will also affect DIC, and the change in DIC due to this should be taken into account (Fig. 28.2). Calcification consumes 1 mol of carbonate (equivalent to 1 mol of DIC or 2 mol of TA) per mole of calcium carbonate formed (Eq. 28.6); thus, half of the change in TA (i.e., the calcification rate) recorded during the experiment needs to be subtracted from the change in DIC to calculate photosynthesis or respiration rates of calcifying organisms.

### 28.2.3.2 Calcification

Calcification is the process by which organisms built their tests, skeletons, or shells made of calcium carbonate. It is the most widespread biomineralization process in the marine biosphere. Examples of calcifiers are planktonic coccolithophores, hermatypic corals, coralline algae, and gastropods. The most direct way to measure calcification is by measuring the increase in calcium carbonate materials, which will most often be the weight of the shell or skeleton. However, the weight of the living tissue or water would confound the measurement; therefore, the buoyant weight is often used. This method consists of measuring the weight of the organisms in water. By knowing the density of water and the density of the calcium carbonate material, it is then possible to determine the increase in mineral between the two measurements. Depending on the organisms, it may be required to correct for the body weight when the density of the living tissue cannot be assumed to equal the density of water. The disadvantage of this technique is that it requires a longer period of time (days to weeks) between measurements to be able to detect the increase. For a shorter period, it is possible to measure calcification by the alkalinity anomaly. TA is the excess of alkali (with a  $pK_a > 10^{-4.5}$ ) in seawater. In seawater, the main components accounting for TA are carbonate and bicarbonate ions. Other ions, such as boric acid, fluoric acid, and, to a lesser extent, nitrate, phosphate, and other nutrients, are also a relatively important part of the TA. Calcification consumes carbonate ions dissolved in seawater (Eq. 28.6), and therefore decreases the TA (Fig. 28.2). For each mole of calcium carbonate formed, two molar equivalents of alkalinity are consumed. The TA can be easily measured by the potentiometric titration of seawater using a strong acid. Typically, a solution of hydrochloric acid at 0.1 N is used. The pH is measured after each addition of HCl and the TA can be calculated by non/linear least square regression (refer to Dickson et al. 2007 and the “alk” function available in the seacarb R package) or by the Gran method (Eq. 28.7).

*Equation for photosynthesis/respiration:*



*Equation for calcification:*



*Equation for the Gran plot used to calculate total alkalinity from a potentiometric titration:*

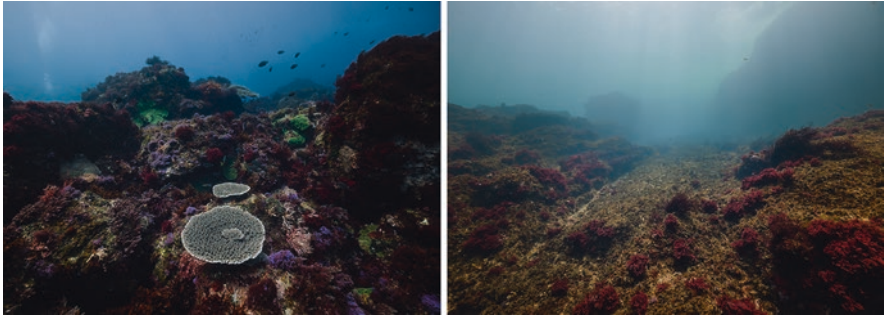
$$G = \left( V_{\text{sample}} + V_{\text{HCl}} \right) \times 10^{4.5 - \text{pH}} \quad (28.7)$$



### 28.3 Other Laboratory Experiments and Field Experiments

Depending on the organism, the hypothesis tested, and the availability of equipment, other experiments can be conducted in the context of a field course. Other parameters are often tested, such as increased nutrient concentrations (nitrates, phosphates, etc.) to test the effect of eutrophication, or decreased oxygen levels to test the effect of hypoxia; the manipulation technique will therefore depend on the nature of the treatment. Common to all manipulation experiments, however, is the need to monitor the levels obtained in the different aquariums. At a minimum, an initial and final measurement should be taken, but regular measurements are preferable. The aim is often not to obtain perfectly constant values, as in nature, very few parameters are constant. For example, the pH in tide pools can be extremely variable because of the intense photosynthetic and respiration activities of the organisms present in the pool. The aim should be to obtain variation of the same order as that experienced in the field. This will often require choosing the correct size of aquarium, as the biological activity of organisms in an aquarium that is too small could lead to important variations. The impact of different nutrient availabilities is easily tested through the addition of nitrates, phosphate, etc., and can be of interest; eutrophication, for example, is a common environmental threat in urbanized areas. The effect of salinity, corresponding, for example, to the gradient observed in estuaries, can be tested by the dilution of seawater, but in such cases, carbonates, nutrients, and perhaps other micronutrients (metals and vitamins) should be re-added, or by using artificial seawater with different salinities.

When laboratory space or equipment is not available, field experiments can be conducted. While such experiments do not allow for the precise control of the environmental conditions, they are often more realistic. Transplantation across natural gradients, such as near estuaries or at different tidal heights in the intertidal zone, can be conducted to test the effect of salinity or air exposure. Shading experiments to test the effect of light on metabolic rates are also common. Experiments related to climate change and ocean acidification are the most difficult to conduct in the field. Warming has been successfully replicated by transplanting organisms from the field onto substrate or into enclosures of different colors (black and white), and consistent increases in temperature could be reached on the dark substrates. Ocean acidification experiments are not easily replicated in the field due to the need to control CO<sub>2</sub>. Several approaches are being used but all require expensive materials or specific sites. Enrichment in CO<sub>2</sub> is performed in open or semi-open areas; mesocosm enclosures into which CO<sub>2</sub> is bubbled have been used to study the effect of CO<sub>2</sub> enrichment on plankton. For benthic organisms, Free Ocean CO<sub>2</sub> Enrichment has been performed by enclosing the organisms and their natural habitat in semi-open chambers, or by bubbling CO<sub>2</sub> nearby. Last, some very specific sites are naturally enriched in CO<sub>2</sub>. These natural analogues provide the only insights into the effects of ocean acidification at the ecosystem level. They are, however, afflicted by some potential confounding factors that should be considered. Areas affected by upwelling currents provide large-scale areas with higher than average CO<sub>2</sub> concentrations. In such systems, it is difficult to define a control area with similar



**Fig. 28.3** Photos of the ecosystems at the reference area (circa 300  $\mu\text{atm}$   $\text{CO}_2$ ; left photo) and elevated  $\text{CO}_2$  near the  $\text{CO}_2$  seep (circa 900  $\mu\text{atm}$ ; right photo) in Shikine Island. Photos by Nicolas Floc'h (ESAB, France)

conditions except for those of  $\text{CO}_2$ , and seasonal variation in the upwelling strength may lead to large variations in the  $\text{CO}_2$  concentration. These systems are therefore more suitable for large-scale processes. Other natural analogues for ocean acidification are areas where  $\text{CO}_2$  seeps through the sea floor into the water column at volcanic islands, such as the sites in Italy (Ischia and Vulcano), Papua New Guinea, and New Zealand, as well as the Shikine (Fig. 28.3) and Iwotori islands in Japan. Nearby areas not affected by the seeping of  $\text{CO}_2$  can be used as control areas, but large variations in  $\text{CO}_2$  are often observed, and because of the scarcity of such sites, it is often difficult to define true independent replicates. Natural analogues are the most effective way to research the effects of ocean acidification at the ecosystem level; unfortunately, however, there are only a handful of sites worldwide, and they are likely not easily accessible for field course.

## References

- Dickson, A. G., Sabine, C. L., & Christian, J. R. (Eds.). (2007). *Guide to best practices for ocean  $\text{CO}_2$  measurements* (Vol. 22). Sidney, BC: North Pacific Marine Science Organization. [http://cdiac.ornl.gov/oceans/Handbook\\_2007.html](http://cdiac.ornl.gov/oceans/Handbook_2007.html)
- Hurlbert, S. H. (1984). Pseudoreplication and the design of ecological field experiments. *Ecological Monographs*, 54(2), 187–211. <https://doi.org/10.2307/1942661>
- IOC, SCOR, IAPSO. (2010). The international thermodynamic equation of seawater—2010: Calculation and use of thermodynamic properties. In *Manuals and guides, intergovernmental oceanographic commission*. Paris: UNESCO.
- IPCC. (2013). *Climate change 2013—the physical science basis: Working group I contribution to the fifth assessment report of the IPCC*. Cambridge: Cambridge University Press.
- Pierrot, D., Lewis, E., & Wallace, D. W. R. (2006). *CO2SYS DOS program developed for CO2 system calculations*, ORNL/CDIAC-105. Oak Ridge, TN: Carbon Dioxide Information Analysis Center, Oak Ridge National Laboratory, US Department of Energy.

---

**Part VI**

**Selected Topics in Marine Biology**



Katsuhiko Tanaka and Kazuo Inaba

## Abstract

Increasing scientific information promote scientists to collect scattered data, put them together and organize them, and make them accessible with the best usability. These data include identification, characterization, habitats and biogeographical distribution, as well as their genomic information. Much of such data are now integrated so as to be accessible for scientists as databases, which are enormously useful to study marine biology. Here we describe some biographic databases and genome/transcriptome databases that are commonly accessed by scientists.

## 29.1 Biogeographic Database

The identification of marine species from the field, with information on the morphology, phylogeny, and habitat, is indispensable to elucidate marine geological and biological environments. A picture guidebook is generally useful for these purposes; now, however, several web-based databases are well-developed for the collection and storage of a large quantity of information and searching of users' queries. In particular, accumulating information on marine species with genomic data enables one to obtain various data types, such as the gene expressions of a species in several tissues and their phylogenetic relationships.

Biogeographic databases provide information on the distribution of an organism, as well as their biodiversity at a regional to global scale. For marine organisms, the

---

K. Tanaka  
School of Marine Science and Technology, Tokai University, Shizuoka, Japan

K. Inaba (✉)  
Shimoda Marine Research Center, University of Tsukuba, Shimoda, Shizuoka, Japan  
e-mail: [kinaba@shimoda.tsukuba.ac.jp](mailto:kinaba@shimoda.tsukuba.ac.jp)

Ocean Biogeographic Information System (OBIS) has collected global data from about 2500 regional/local databases and integrated over 52 million occurrence records of over 120,000 marine species. Each record includes the locality of a species in a collection/observation. OBIS was constructed by a global research/monitoring project (Census of Marine Life [CoML]; Decker and O'Dor 2002; Halpin et al. 2006) and was opened to the public in 2000. It is currently operated as shared property under the Intergovernmental Oceanographic Data and Information Exchange in the United Nations Educational, Scientific and Cultural Organization (UNESCO). The Autonomous Reef Monitoring Structures (ARMS) Program is aimed toward collecting sessile organisms for CoML projects, and the database is managed by the Smithsonian Institute (Plaisance et al. 2009). Using OBIS, users can freely search records by organism name, geographic region, etc., and can then visualize their distribution on a scalable map. OBIS data are also downloadable for secondary use or further analyses. The information on OBIS contributes to understanding the distributions and diversity of marine organisms and has been used for the prediction of marine species distributions, such as future marine biodiversity patterns under climate change, in combination with environmental datasets/models.

In Japan, the Biological Information System for Marine Life (BISMaL) constructed by the Japan Agency for Marine-Earth Science and Technology (JAMSTEC) is a useful data source to learn marine biodiversity around Japan (Fig. 29.1). BISMaL is an integrated database dealing with different kinds of information. It provides taxonomic information (scientific names of species and their higher classification) on marine organisms around Japan as well as their occurrence records from several datasets. An organism is searchable by name/hierarchical taxonomic tree. Descriptions of the morphology and ecology, as well as photographs, are available for some organisms, and movies taken during deep-sea surveys by JAMSTEC are also provided for deep-sea species. Users can search and visualize occurrence records on a map, filter them by taxonomic group, dataset, and depth, and download them for further analyses.

BISMaL has collected over 450,000 occurrence records for over 6200 species. The data is still too poor to completely cover the marine biodiversity around Japan; thus, the Japan Ocean Biogeographic Information System Center is calling for research communities in Japan to provide data to BISMaL to establish a robust data source for related fields. Such data collections may also be beneficial for data providers because BISMaL, as an OBIS node providing regional information to OBIS, send data to OBIS, which are then integrated with other data from various regions and opened to the public. A regional database such as BISMaL can be not only a data source, but also a useful tool for data publication online, and provides a way for every scientist/scientific community to contribute to the global dataset. Other than BISMaL, several excellent public and private databases are available to access information on marine organisms online. For example, the Japanese Association for Marine Biology (JAMBIO) is continuously conducting a joint survey and summarizes the marine organisms collected as the database "RINKAI" (Inaba 2015).

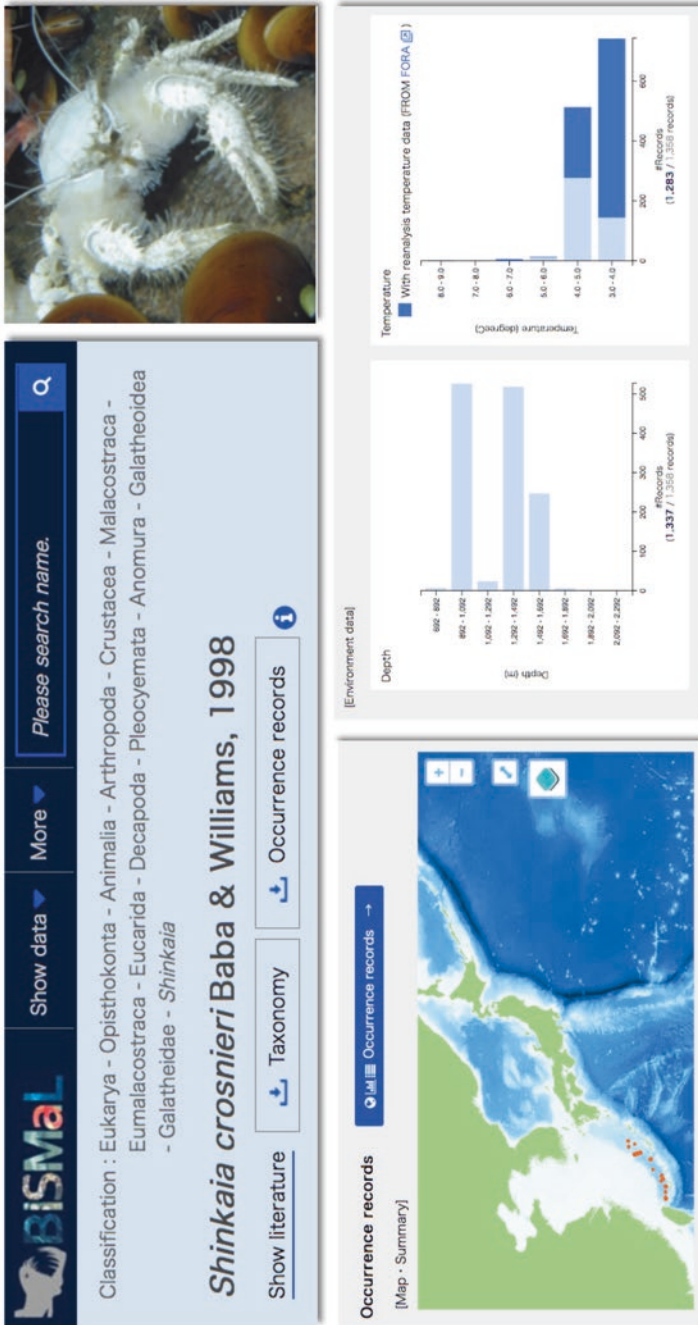


Fig. 29.1 An integrated database for marine organisms, the Biological Information System for Marine Life (BISMAL).

## 29.2 Genome and Transcriptome Database

For the DNA-based identification of a specific organism or a mass organism survey in marine environments, DNA barcoding and environmental DNA (eDNA) are powerful tools. The former is a method for the rapid identification of known or unknown species by using a short fragment of mitochondrial cytochrome oxidase I (COI or COX1) or the nuclear ribosomal RNA internal transcribed spacer (ITS). The latter is a mass metagenomic analysis of single and multi species from a variety of environmental samples, such as sea water, containing diverse DNA sources from tissue debris and feces. It provides information on species distributions, population, and ecosystems and is useful for environmental biomonitoring.

After complete determination of genome sequences in the pufferfish *Takifugu rubripes* and the ascidian *Ciona intestinalis* in 2002, genomic information has been rapidly accumulated for many other marine organisms, due to the development of next generation sequencing. The marine organisms in which complete genome sequences are available include the diatom (*Thalassiosira pseudonana*), brown algae (*Ectocarpus siliculosus*), sponge (*Amphimedon queenslandica*), cnidarians (*Nematostella vectensis*, *Clytia hemisphaerica*, and *Acropora digitifera*), ctenophores (*Mnemiopsis leidyi* and *Pleurobrachia bachei*), sea urchins (*Strongylocentrotus purpuratus*, *Hemicentrotus pulcherrimus* [the latter is a Japanese species]), lancelet (*Branchiostoma floridae*), bivalve (*Spisula solidissima*), shrimp (*Litopenaeus vannamei*), and many others. In some marine organisms without full genome sequences, many sequence data are available from RNAseq analysis of expressed genes (transcriptomes).

The sequences determined independently by researchers with annotations from a single gene or those from mass sequencing are, as ever, submitted to a fundamental initiative for sequence database collaboration that operates the DNA Data Bank of Japan (DDBJ), European Molecular Biology Laboratory European Bioinformatics Institute (EMBL-EBI) (ENA; European Nucleotide Archive), and National Center for Biotechnology Information (NCBI) (GenBank). The genome information can be accessed from their genome browsers, where online search tools, including BLAST searches, can be used against the sequence data of a specific organism or mass sequence data. It is often necessary to access the genome information for multiple marine organisms. In these cases, it is useful to obtain information through portal sites. For prokaryotes, there are well-organized databases for marine microbial genomes: MarRef, MarDB, and MarCat. MarBEF is one of the two networks for European marine ecosystem research, along with Marine Genomics Europe (MGE) (Klemetsen et al. 2018). These are easily accessed through the Marine Metagenomics Portal (MMP) (<https://mmp.sfb.uit.no/>). Other useful metagenomic databases include the Genomes OnLine Database (GOLD), Viral Informatics Resource for Metagenome Exploration (VIROME), MGnify (formerly EBI Metagenomics), Integrated Microbial Genomes and Microbiomes (IMG/M), and Marine Life Genome Database (MLGD).

A few mass collections of marine organisms are operated, such as the Global Ocean Sampling (GOS) Expedition on Sorcerer II (J. Craig Venter Institute) and the

Tara Expedition (Tara Foundation). The latter implemented an expedition named “Tara Pacific” from 2016 to 2018, which included the investigation of Japanese coasts (Carradec et al. 2018). Samples from the previous expedition, “Tara Oceans,” are mapped to the external Tara Oceans Sample Registry at PANGAEA (<http://www.pangaea.de/>). Their information and the primary sequence data can be accessed through EMBL-EBI ([www.ebi.ac.uk/ena/data/view/PRJEB402](http://www.ebi.ac.uk/ena/data/view/PRJEB402); [www.ebi.ac.uk/metagenomics/](http://www.ebi.ac.uk/metagenomics/); [www.ebi.ac.uk/metagenomics/projects/ERP001736/](http://www.ebi.ac.uk/metagenomics/projects/ERP001736/)).

---

## References

- Carradec, Q., Pelletier, E., Da Silva, C., Alberti, A., Seeleuthner, Y., Blanc-Mathieu, R., et al. (2018). A global ocean atlas of eukaryotic genes. *Nature Communications*, 9, 373. <https://doi.org/10.1038/s41467-017-02342-1>.
- Decker, C. J., & O’Dor, R. (2002). A census of marine life: Unknowable or just unknown? *Oceanologica Acta*, 25, 179–186.
- Halpin, P. N., Read, A. J., Best, B. D., Hyrenbach, K. D., Fujioka, E., et al. (2006). OBIS-SEAMAP: Developing a biogeographic research data commons for the ecological studies of marine mammals, seabirds, and sea turtles. *Marine Ecology Progress Series*, 316, 239–246.
- Inaba, K. (2015). Japanese marine biological stations: Preface to the special issue. *Regional Studies in Marine Sciences*, 2, 154–157.
- Klemetsen, T., Raknes, I. A., Fu, J., Agafonov, A., Balasundaram, S. V., Tartari, G., et al. (2018). The MAR databases: Development and implementation of databases specific for marine metagenomics. *Nucleic Acids Research*, 46(D1), D692–D699.
- Plaisance, L., Knowlton, N., Paulay, G., & Meyer, C. (2009). Reef-associated crustacean fauna: Biodiversity estimates using semi-quantitative sampling and DNA barcoding. *Coral Reefs*, 28, 977–986.





Katsufumi Sato

## Abstract

When the first biologging international symposium was held in Tokyo in 2003, the newly coined term “biologging” was defined as the investigation of phenomena in or around free-ranging organisms that are beyond the boundary of our visibility or experience. Small recorders mounted on animals obtain time-series data that, when analyzed, reveal movements, behavior, physiology, and ecology under natural conditions. Biologging was first implemented on seals and penguins in Antarctic regions, then applied to cetaceans, seabirds, sea turtles, and fishes in tropical and temperate regions. Recent technical innovations have both decreased recorder size and increased diversity of the parameters recorded. Early recorders could only measure depth and temperature. More recent devices can record swim speed, 3D dive paths, GPS position, swimming or flying efforts (acceleration), electrocardiology, brain waves, and environmental parameters through video recordings. Biologging was originally designed by and for biologists; however, since the early 2000s, biologging data have monitored the physical environment in which the animals live. For example, diving animals such as seals, penguins, and turtles are now used to sample marine depth-temperature profiles. Furthermore, GPS tracking data of flying seabirds are capable of monitoring sea surface currents and ocean winds.

---

K. Sato (✉)

Atmosphere and Ocean Research Institute, The University of Tokyo, Kashiwa, Japan  
e-mail: [katsu@aori.u-tokyo.ac.jp](mailto:katsu@aori.u-tokyo.ac.jp)

## 30.1 Genesis of Biologging

Biologging is a methodology used to investigate the behavior, physiology, and ecology of animals under natural conditions. Small recorders are mounted on free-ranging animals and obtained time-series data are analyzed to understand the hidden life of animals. In the early 1960s, Gerald Kooyman first developed time-depth recorders adapted from a kitchen timer and deployed them on Weddell seals (*Leptonychotes weddellii*) in Antarctica. It surprised physiologists that these animals can dive deeper than 600 m and for longer than 40 min (Kooyman 1966). Wilson and Naito developed animal-borne recorders independently in the early 1980s. Small depth and speed meters developed by Wilson were deployed on jackass penguins (*Spheniscus demersus*) (body mass: 2.2–3.5 kg) (Wilson and Bain 1984a, b). He also pioneered the use of waterproof tape to fix devices to the feathers of birds (Wilson et al. 1997). This method is now widely used in biologging studies involving seabirds. Naito developed mechanical recorders that can monitor the diving behavior of northern elephant seals (*Mirounga angustirostris*) for up to 3 months. The seals were recorded performing long (average 20 min) and deep (several hundred meters) dives with a 3.5 min surfacing time during foraging trips lasting 80 days (Le Boeuf et al. 1989).

Technical innovation in the 1980s made the further miniaturization of recorders possible. Early recorders could measure only depth (pressure) and temperature. More recent devices can record behavioral parameters, such as swim speed, 3D dive paths, GPS position, swimming or flying efforts (acceleration), and physiological parameters, such as body temperature, electrocardiology, brain waves, and environmental parameters through video recordings. Target species have grown from seals and penguins in Antarctica to cetaceans, seabirds, sea turtles, and fishes in tropical and temperate regions. In 2003, the first international symposium was held in Tokyo. A new term “Bio-logging” was proposed by the organizing committee and was defined as the “investigation of phenomena in or around free-ranging organisms that are beyond the boundary of our visibility or experience” (Boyd et al. 2004). Since then, a symposium has been held every 2 or 3 years in several locations around the world, and the term has been slightly modified to “biologging.”

---

## 30.2 Application of Biologging to Study Marine Animals in Coastal Areas Around Japan

Biologging was first applied to study animals living in Antarctica. Seals and penguins in Antarctica have no experience of land-living apex predators; thus, they are less wary of humans. It is therefore relatively easy for scientists to capture them to deploy and retrieve devices. However, marine animals living in coastal areas around Japan are more exposed to predators and are thus more wary of human interaction. Capturing animals is the first hurdle for scientists wishing to use biologging techniques. After releasing animals with devices, scientists need to recapture them for device retrieval. For example, adult female sea turtles land on sandy beaches to lay

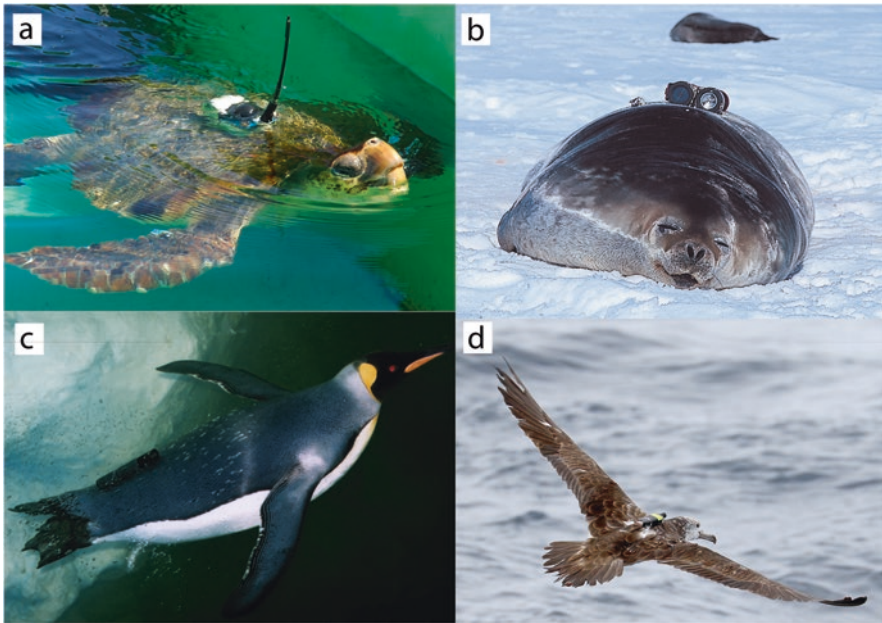
eggs. They produce several nests on the same beach at two- to three-week intervals during the reproductive season. If scientists deploy recorders on nesting females during the early reproductive season, they can expect to recapture and retrieve the devices when the turtles return to the same beach for the next nesting (Sato et al. 1994). In the case of chum salmon (*Oncorhynchus keta*), they are born in a river, mature in the ocean, and return to the natal river to spawn. Because there are about 30 salmon hatcheries in the area, there is a rich stock of chum salmon on the Sanriku Coast, in the northern part of Honshu Island, Japan. Chum salmon returning to the Sanriku Coast usually ascend their natal rivers within a few weeks. Scientists deployed recorders on salmon captured by set nets in the coastal area and released them into the sea. Recorders were sutured to the body with the laboratory address and a request to return the recorders printed on them. About 50% of the released fish were recaptured by set nets in the coastal area and mouths of rivers (Tanaka et al. 2000).

In the case of most target species, it is almost impossible to recapture animals with devices. A time-scheduled release system allows more target species to be studied via biologging. For example, ocean sunfish (*Mola mola*) were captured alive in set nets off the Sanriku Coast. On the fishermen's boat, scientists pierced a tiny hole in the back of the fish through the skin and the subcutaneous gelatinous layer. Recorders with devices for data recovery (time-scheduled releasing system, float, and VHF transmitter) were attached to the fish using a cable tie through the hole, and the fish were released within 5 min. During the attachment procedure, the gills were flushed with fresh seawater. Several days later, the time-scheduled releasing system detached the devices from the fish, and the device floated on the water surface. The devices were then located by VHF radio signal and recovered by a research vessel. Ocean sunfish have laterally compressed deep bodies and lack caudal fins. This morphological appearance gives the impression of a planktonic inactive swimmer. Furthermore, ocean sunfish are often observed lying on their sides and drifting at the sea surface. Biologging provided direct information on their locomotor performance under natural condition, and it was revealed that sunfish swam continuously with frequent vertical movements, similar to other large fishes such as salmon, tunas, and pelagic sharks (Watanabe and Sato 2008).

---

### 30.3 Recent Advancements of Physical Observations Using Biologging

Biologging was originally designed by biologists to study marine megafauna. Since around 2000, biologging data have been used for monitoring the physical environment where animals live. Satellites are widely used to monitor sea surface temperature; however, satellites cannot measure water temperature distributions below the sea surface. Air-breathing animals show repeated vertical movements between sea surface and to depths where prey is to be found. Marine mammals, penguins, and turtles are used as living samplers of depth-temperature profiles. Furthermore, GPS tracking data of flying seabirds are available to monitor sea surface currents and



**Fig. 30.1** Target species of biologging. (a) loggerhead turtle, (b) Weddell seal, (c) king penguin, and (d) streaked shearwater with animal-borne devices. The picture of the streaked shearwater was taken by Yusuke Goto

ocean winds. Seabirds floating on the ocean can be used as Lagrangian current sensors, much like drifting buoys (Yoda et al. 2014). The flight paths of seabirds soaring over the ocean surface enable the measurement of wind speed and direction (Yonehara et al. 2016). Biologging has several challenges yet to overcome, such as how, when, and where to attach loggers on animals; how to retrieve them; how to realize real-time monitoring; and how to validate the accuracy of readings. Nonetheless, future technologies will provide further developments that will provide precious atmospheric and oceanic data from animals tagged with increasingly sophisticated biologging devices (Fig. 30.1).

## References

- Boyd, I. L., Kato, A., & Ropert-Coudert, Y. (2004). Bio-logging science: Sensing beyond the boundaries. *Memoirs of National Institute of Polar Research*, 58, 1–14.
- Kooyman, G. L. (1966). Maximum diving capacities of the Weddell seal, *Leptonychotes weddellii*. *Science*, 151, 1553–1554.
- Le Boeuf, B. J., Naito, Y., Huntley, A. C., et al. (1989). Prolonged, continuous, deep diving by northern elephant seals. *Canadian Journal of Zoology*, 67, 2514–2519.
- Sato, K., Sakamoto, W., Matsuzawa, Y., et al. (1994). Correlation between stomach temperatures and ambient water temperatures in free-ranging loggerhead turtles, *Caretta caretta*. *Marine Biology*, 118, 343–351.

- Tanaka, H., Takagi, Y., & Naito, Y. (2000). Behavioural thermoregulation of chum salmon during homing migration in coastal waters. *The Journal of Experimental Biology*, *203*, 1825–1833.
- Watanabe, Y., & Sato, K. (2008). Functional dorsoventral symmetry in relation to lift-based swimming in the ocean sunfish *Mola mola*. *PLoS One*, *3*, e3446.
- Wilson, R. P., & Bain, C. A. R. (1984a). An inexpensive depth gauge for penguins. *Journal of Wildlife Management*, *48*, 1077–1084.
- Wilson, R. P., & Bain, C. A. R. (1984b). An inexpensive speed meter for penguins at sea. *Journal of Wildlife Management*, *48*, 1360–1364.
- Wilson, R. P., Putz, K., Peters, G., et al. (1997). Long-term attachment of transmitting and recording devices to penguins and other seabirds. *Wildlife Society Bulletin*, *25*(1), 101–106.
- Yoda, K., Shiomi, K., & Sato, K. (2014). Foraging spots of streaked shearwaters in relation to ocean surface currents as identified using their drift movements. *Progress in Oceanography*, *122*, 54–64.
- Yonehara, Y., Goto, Y., Yoda, K., et al. (2016). Flight paths of seabirds soaring over the ocean surface enable measurement of fine-scale wind speed and direction. *PNAS*, *113*, 9039–9044.



Koji Hamasaki

## Abstract

What kinds of microbes are in the ocean? What are they doing? If you go to the ocean today, you can find 1 million bacteria and 100 million viruses in a tiny drop of seawater. You will also find diverse microbial entities, such as photosynthetic microalgae, protozoan amoebae, and quick-swimming ciliates in the water. Although we often overlook their existence due to their invisibility to the naked eye, they are vital for all living organisms (including human beings) on earth. Recent scientific studies have revealed that microbes play key roles in ocean ecosystems and are closely related to currently debated issues in our society, such as the sustainability of natural environments, global environmental change, and human health. Additionally, they have been recognized as promising gene resources, most of which have never been explored. Microbes have been traditionally studied by culture-dependent methodologies. However, only a limited fraction of microbial communities in nature can be grown on conventional nutrient agar plates, and thus most microbes existing in natural environments have never been cultured yet. Recent developments in culture-independent methodologies have enabled us to study such yet-to-be-cultured microbes. Direct microscopic observations and analyses of microbial DNA and RNA sequences directly collected from environmental samples can show us the abundance, biomass, diversity, and functional potentials of microbes in each particular environment. From this, it has been possible to improve our understanding of microbial worlds in marine environments.

---

K. Hamasaki (✉)

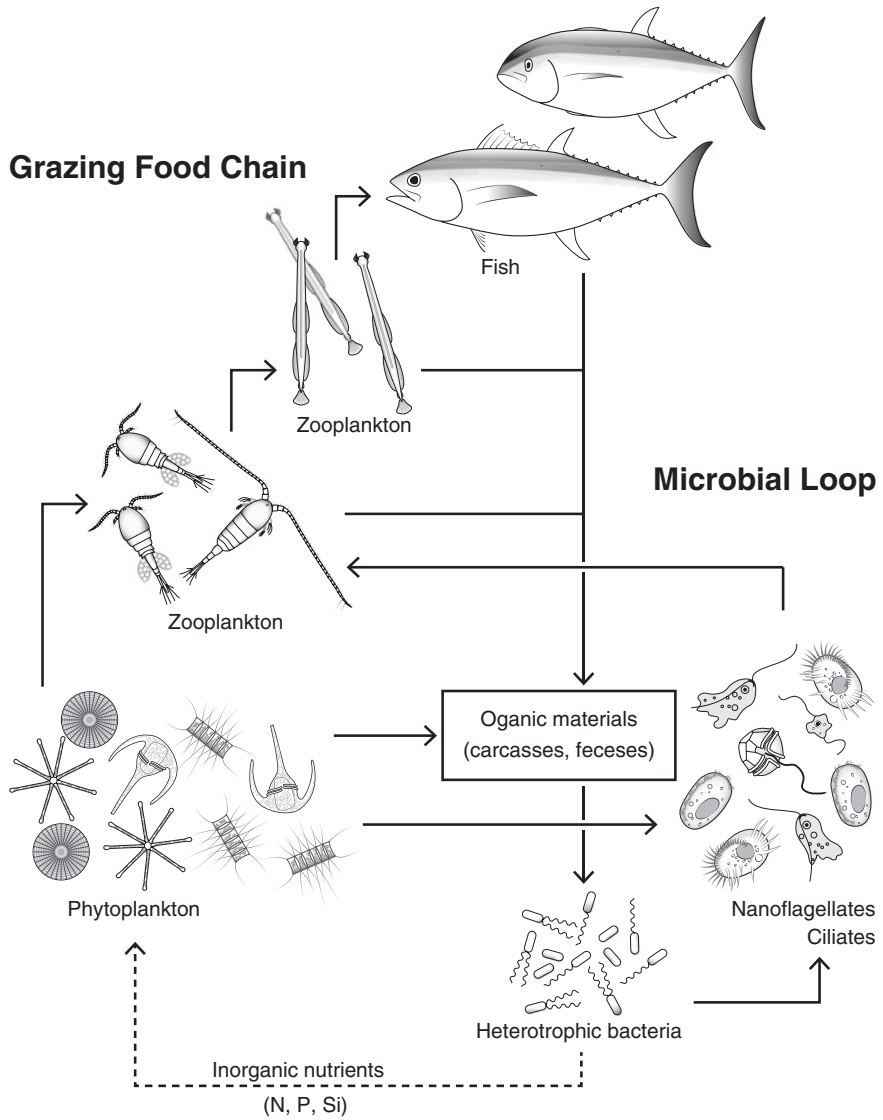
Atmosphere and Ocean Research Institute, The University of Tokyo, Tokyo, Japan  
e-mail: [hamasaki@aori.u-tokyo.ac.jp](mailto:hamasaki@aori.u-tokyo.ac.jp)

## 31.1 Roles in Marine Ecosystems

A traditional concept of marine ecosystems is the structured predator–prey relationships of phytoplankton (microalgae), zooplankton, and fish, the so-called grazing food chain. In this concept, heterotrophic bacteria decompose organic materials released as waste from the grazing food chain, and regenerate inorganic nutrients. However, a modern concept emphasizes predator–prey relationships of microbes, which are important for organic matter flux in marine ecosystems (Fig. 31.1). This process, so-called microbial loop, starts from the bacterial consumption of dissolved organic materials supplied through the grazing food chain, linking to a microbial food chain of bacteriovorus nanoflagellates, ciliates, and mesozooplankton (Azam et al. 1983; Lalli and Persons 1997). The development of the fluorescence microscope in the 1970s significantly progressed methodologies for observing and counting microbes in seawater, which lead to researchers realizing the significance of the microbial biomass and proposing the “microbial loop” concept. In this method, seawater samples are sorted by a membrane filter (normally 0.22  $\mu\text{m}$  pore size) for microbe collection, and stained by a fluorescent dye which is intercalated into the DNA of the microbial cells. Then, the microbes can be observed as fluorescent cells and counted under a microscope to measure their abundance in a unit of seawater. The cells can be identified into each type of microbe based on their size and the presence/absence of nuclei and plastids. Heterotrophic bacteria and archaea look like small fluorescent particles, whereas flagellates and ciliates look like bigger particles with strongly stained nuclei. In addition, autotrophic microbes can be identified by the autofluorescence of the photosynthetic pigments within their cells. We can even observe and count viruses with the use of highly efficient fluorescent chemicals. A flow-through laser-based analysis of fluorescent cells, called flow cytometry, has been also used for counting microbes in seawater. Microbial identification by flow cytometry is based on the cell size and fluorescence, which is same as that by fluorescence microscopy. Seawater samples can be directly analyzed by flow cytometer without filtration. To learn more details, see Kemp et al. (1993), Kirchman (2010, 2018) and Fuhrman and Caron (2016).

## 31.2 Diversity

How do we know the diversity of microbes in the environment? As described above, culture-dependent identification is insufficient to study microbes living in natural environments. To understand microbial diversity and community structures in the environment, culture-independent methodologies based on DNA and RNA sequencing have been in development since the 1990s (Rappé and Giovannoni 2003). Briefly, samples (e.g., seawater filtrate, sediment, organisms) are subjected to the extraction of DNA/RNA followed by PCR amplification of the 16S/18S rRNA genes. The ribosomal RNA gene is the most frequently used marker for microbial identification. Once sequences from the samples are obtained, a homology search in a database of rRNA genes identifies the taxonomic assignments of the



**Fig. 31.1** Microbes are all small in size but are essential in the marine ecosystem

queried sequence. PCR amplicons from natural samples are a mixture of variable sequences originating from diverse microbial species. Since microbial gene sequences often show variability within a species, sequences sharing a certain level of similarity are clustered in groups called operational taxonomic units (OTUs). After sequencing PCR amplicons, the sequence reads are often clustered with 97% similarity threshold to make OTUs. Then, the number of OTUs is used as a proxy of



species richness, and relative read numbers of OTUs are used to show community structures and calculate species evenness.

Sequencing of rRNA gene PCR amplicons has been performed by Sanger Sequencing in combination with *E. coli* cloning since the 1990s. This approach is labor intensive and requires substantial costs. However, new types of sequencing methods, called “next-generation sequencing” (NGS), have been developed in the past few decades. NGS has then dramatically increased the throughput and reduced the costs of sequencing, which has enabled us to sequence hundreds of samples collected from various environments with reasonable costs and time. For example, the International Census of Marine Microbes, a pioneering large-scale survey of microbial diversity, collected over 500 seawater and sediment samples from the world’s oceans and produced 9.6 million reads of rRNA sequences (Zinger et al. 2011). The result showed 12,000 OTUs in total, suggesting the extent of microbial diversity in the ocean. We have realized that we can expect many more novel species still waiting for isolation and cultivation from environmental samples, although the number of bacterial species isolated and stored in public culture collections is currently at about 10,000.

---

### 31.3 Metagenomics

Metagenomics is the analysis of whole microbial community genomes in environmental samples (DeLong 2005; DeLong and Karl 2005). The sequence-based approach of metagenomics directly sequences DNA extracted from environmental samples without PCR amplification. This used to be impractical, because it requires much more sequencing effort than rRNA-based approaches. However, it has become more feasible since the introduction of NGS. As described above, sequencing rRNA genes amplified from environmental samples enables us to determine the taxonomic affiliation of microbes and their relative abundance in natural communities. Although this approach gives us the identities (e.g., species names) and diversity of microbes in the environment, it never provides estimates of their functional characteristics and ecological roles. Metagenomics can give us the lists of genes and indicate their detailed biological characteristics and metabolic potentials. It is a powerful tool to elucidate how microbial communities live in the environment.

Early attempts at metagenomics in the 2000s revealed unprecedented diversity and functions of microbial genes in the ocean. A research group led by J. Craig Venter collected surface seawater samples during a circumnavigation of the globe called the “Global Ocean Sampling”, and found over 6 million protein-coding genes, including 1700 novel proteins using sequence-based metagenomic analysis (Yooseph et al. 2007). Another significant finding by metagenomics was the discovery of “proteorhodopsin,” a light-sensitive transmembrane protein possessed by proteobacteria in the ocean (Béja et al. 2000). Metagenomic surveys of microbial community genomes in surface seawater samples first revealed the presence of a rhodopsin-like gene originating from a genome fragment of an uncultured bacterial taxa. Subsequent works using *E. coli* gene expression

system proved that this gene encoded a light-driven proton pump, which had reportedly been possessed only by some archaea living in extremely high-salinity environments. Currently, about half of the bacteria in the surface waters of the ocean are reported to possess proteorhodopsin. It was surprising that this gene, formerly believed to work only in extreme environments, was found in a major bacterial group in seawater environments. Proteorhodopsin absorbs light with a covalently bound pigment and produces a transmembrane proton gradient followed by ATP synthesis, which is an efficient light-utilization system to supplement the energy source of heterotrophic bacteria. Generally speaking, the surface ocean is a nutrient-poor environment for microbes. It should be reasonable that many microbes living in the ocean have evolved a light-utilization system other than photosynthesis.

---

## 31.4 Microbiome

A microbial community collectively functioning in a particular environment is called a “microbiome” (Turnbaugh et al. 2007). It is often used in terms of host–microbe associations, such as the human microbiome, plant microbiome, and fish microbiome. Microbes in marine environments live not only in seawater but also in association with various marine animals and plants. Although host–microbes associations have long been studied by means of culture-dependent methodologies, recent progress in culture-independent methodologies, especially the use of NGS, has dramatically enhanced our ability to understand host-associating microbes. Knowledge on the human microbiome has been rapidly expanding due to its importance in human health, and has revealed the relationship between microbial communities and the various physiological responses of their host. Analogous studies have been performed on the fish microbiome (e.g. Egerton et al. 2018). Some studies have suggested a correlation between gut microbial communities and the growth of fish larvae. Another study suggested the effect of some intestinal bacteria on inducing an immune response in fish. The application of microbiomes to control the health of fish is attracting considerable interest in the field of aquaculture. Likewise, microbes associating with various marine animals and plants may affect their host’s physiology and behavior more strongly than we have considered. There could be many unknown interactions between microbes and marine organisms. Microbiome studies with the use of NGS are emerging fields in marine microbiology.

---

## References

- Azam, F., Fenchel, T., Field, J. G., Gray, J. S., Meyer-Reil, L. A., & Thingstad, F. (1983). The ecological role of water-column microbes in the sea. *Marine Ecology Progress Series*, 10, 257–263.
- Béja, O., Aravind, L., Koonin, E. V., Suzuki, M. T., Hadd, A., Nguyen, L. P., et al. (2000). Bacterial rhodopsin: Evidence for a new type of phototrophy in the sea. *Science*, 289, 1902–1906.

- DeLong, E. F. (2005). Microbial community genomics in the ocean. *Nature Reviews Microbiology*, 3, 459–469.
- DeLong, E. F., & Karl, D. M. (2005). Genomic perspectives in microbial oceanography. *Nature*, 437, 336–342.
- Egerton, S., Culloty, S., Whooley, J., Stanton, C., & Ross, R. P. (2018). The gut microbiota of marine fish. *Frontiers in Microbiology*, 9, 873.
- Fuhrman, J. A., & Caron, D. A. (2016). Heterotrophic planktonic microbes: Virus, bacteria, archaea, and protozoa. In *Manual of environmental microbiology* (4th ed., pp. 4–2). Washington, DC: American Society of Microbiology.
- Kemp, P. F., Cole, J. J., Sherr, B. F., & Sherr, E. B. (Eds.). (1993). *Handbook of methods in aquatic microbial ecology*. Boca Raton, FL: CRC Press.
- Kirchman, D. L. (2018). *Processes in microbial ecology*. Oxford: Oxford University Press.
- Kirchman, D. L. (Ed.). (2010). *Microbial ecology of the oceans*. Hoboken, NJ: Wiley.
- Lalli, C., & Parsons, T. R. (1997). *Biological oceanography: An introduction*. Burlington, MA: Butterworth-Heinemann.
- Rappé, M. S., & Giovannoni, S. J. (2003). The uncultured microbial majority. *Annual Reviews in Microbiology*, 57, 369–394.
- Turnbaugh, P. J., Ley, R. E., Hamady, M., Fraser-Liggett, C. M., Knight, R., & Gordon, J. I. (2007). The human microbiome project. *Nature*, 449, 804–810.
- Yooseph, S., Sutton, G., Rusch, D. B., Halpern, A. L., Williamson, S. J., Remington, K., Jaroszewski, L. (et al.) (2007). The Sorcerer II global ocean sampling expedition: Expanding the universe of protein families. *PLoS Biology*, 5, e16.
- Zinger, L., Amaral-Zettler, L. A., Fuhrman, J. A., Horner-Devine, M. C., Huse, S. M., Welch, D. B. M., et al. (2011). Global patterns of bacterial beta-diversity in seafloor and seawater ecosystems. *PLoS One*, 6, e24570.



Abigail McQuatters-Gollop

## Abstract

The marine environment is highly species-rich and home to hundreds of thousands of species along with the diverse habitats that support them. Humans also use our marine waters for a range of activities from fishing, to shipping, to recreation. These human activities may negatively impact the quality of the marine environment, damaging sensitive habitats and harming marine species. Marine conservation efforts are therefore essential for protecting the ocean's biodiversity and ensuring that society uses marine resources sustainably.

## 32.1 The Marine Environment Is Biodiverse

Oceans and seas have a high number of species and a wide range of habitats, with some studies suggesting that only 10% of marine species have been identified and described (Mora et al. 2011). Collectively, these species and habitats can be referred to as “marine biodiversity.” Marine biodiversity encompasses all life in the marine environment, from viruses to single-celled phytoplankton to whales, and includes habitats such as kelp forests, abyssal plains, coral reefs, and the open oceans. The diversity of life in the oceans supports complex processes and functions occurring in marine waters, including carbon and nutrient cycling, trophic interactions, and climate regulation. For example, phytoplankton produce 50% of global oxygen. Without marine biodiversity, our planet would look and function very differently.

---

A. McQuatters-Gollop (✉)

Centre for Marine Conservation and Policy, University of Plymouth, Plymouth, UK

e-mail: [abigail.mcquatters-gollop@plymouth.ac.uk](mailto:abigail.mcquatters-gollop@plymouth.ac.uk)

© Springer Nature Singapore Pte Ltd. 2020

K. Inaba, J. M. Hall-Spencer (eds.), *Japanese Marine Life*,

[https://doi.org/10.1007/978-981-15-1326-8\\_32](https://doi.org/10.1007/978-981-15-1326-8_32)

---

## 32.2 What Is Marine Conservation?

Human activities can negatively impact marine biodiversity, harming wildlife and diminishing the ability of oceans to support ecological functions and processes. For example, overfishing can both damage benthic habitats and alter food webs, changing predator-prey relationships and the transfer of energy between trophic levels. Coastal development can destroy habitats, such as mangroves and seagrass meadows, decreasing the biodiversity of these systems and diminishing the natural protection that coastlines offer against storm events. Plastic is polluting beaches and waterways worldwide, and is increasingly found in the guts of fish, seabirds, whales, and even plankton. In addition to these direct human pressures, anthropogenic climate change and ocean acidification, caused by carbon emissions, are additional stressors on marine ecosystems. Climate change is increasing sea temperatures and altering biogeochemical cycling and biological distributions, while ocean acidification is changing the pH of the ocean and impacting biological and physiological processes. Managing these human pressures on the marine environment is complex, particularly for climate change and ocean acidification, which can only be managed through a global reduction in carbon emissions.

Marine conservation helps to safeguard the ocean's biodiversity. Conservation efforts can focus on the marine environment at the single species, species group, habitat, or ecosystem level. Marine conservation seeks to protect or restore species and habitats by managing the human pressures directly impacting them. In this way, conservation works to maintain or increase the health of marine biodiversity, resulting in species and ecosystems which may be more resilient to the effects of climate change and ocean acidification. Marine conservation is an interdisciplinary field, requiring expertise from individuals in the fields of marine biology, oceanography, fisheries, marine policy, law, and social science.

---

## 32.3 How Do We Conserve the Marine Environment?

Marine and coastal environments vary in their biodiversity and human uses. Management of these environments therefore requires a variety of conservation techniques across multiple political scales, from international agreements to community plans. Using the marine ecosystem sustainably, in a way that ensures its species, habitats, processes, and functions are preserved for future generations, is the key to effective marine conservation and management.

Environmental conventions, international agreements formed to address particular challenges, are a fundamental conservation technique. An important milestone in marine conservation occurred in 1946, with the establishment of the International Whaling Commission (IWC) in response to the systematic global depletion of whales due to hunting. The IWC adopted a moratorium on commercial whaling in 1982, which is implemented by 89 countries worldwide. The moratorium has achieved successful results, with some species, such as the humpback whale (*Megaptera novaeangliae*), substantially increasing in abundance from near

extinction, although other species, like the North Atlantic right whale (*Eubalaena glacialis*), remain critically endangered. Japan had been a member of the IWC, but withdrew in 2019. This issue is controversial among Japanese people, including scientists, nature conservation groups, politicians, and general citizens.

In 1992, the United Nations Convention on Biological Diversity (CBD) provided a legal basis for biodiversity conservation (United Nations 1992). The objectives of the CBD are to conserve and sustainably use biodiversity and share genetic resources. Globally, 196 countries (including Japan) have signed the convention, and are therefore committed to creating and implementing biodiversity conservation, both on land and in the marine environment. The CBD's Aichi Biodiversity Targets were established in 2010 to provide a pathway for member countries to halt biodiversity loss, promote the sustainable use of biodiversity, improve the health of species and habitats, enhance the benefits of biodiversity, and improve participation in biodiversity management (United Nations General Assembly 2015).

Humans are not separate from the marine environment, but depend on the seas and oceans for food, recreation, transportation, and cultural activities. The “ecosystem approach” to marine management considers humans as part of the ecosystem, and is a balance of conservation and sustainable use (United Nations 2000). Implementation requires a scientific understanding of the marine system, as well as knowledge of the services provided to humans by the marine environment. An ecosystem approach to fisheries management, for example, is used not only to manage fish stocks, but also limit the impact that fishing has on the wider ecosystem. Examples of such management measures include reducing the accidental catch of non-target species (known as “bycatch”), and protecting areas of the seabed from the damaging effects caused by trawling, which drags heavy fishing gear along the ocean floor, destroying benthic habitats.

Marine protected areas (MPAs) are a common marine conservation tool that is often implemented as part of an ecosystem approach to marine management. MPAs protect areas of the marine environment from damaging human activities, such as certain types of fishing or oil exploration. MPAs can have different levels of protection, from strictly controlled reserves which may prohibit all human activities, to protected areas where recreational fishing may be allowed but commercial fishing is forbidden (Fig. 32.1). Globally, MPAs that prohibit fishing are, on average, 670% richer in fish biomass than their adjacent unprotected areas (Sala and Giakoumi 2017). MPAs can even increase fishery catches in nearby unprotected areas, as fishes show “spillover” from the MPA into the adjacent waters (Halpern et al. 2010). The conservation benefits of MPAs are recognized internationally, with Aichi Target 11 requiring the protection of 10% of global marine and coastal areas (United Nations General Assembly 2015). MPAs alone will not protect marine biodiversity, however, as some key ecosystem components, such as ecological processes and mobile species like cetaceans, cannot be protected through area-based management (Mora and Sale 2011).



**Fig. 32.1** Small scale fishing in Bako National Park, Malaysia

## 32.4 The Role of Data in Marine Conservation

Data and scientific research about the marine environment form a critical scientific evidence base that supports marine conservation. Due to the difficulty and expense of surveying the marine environment, marine biodiversity data are generally limited with regard to their spatial and temporal extent, making it challenging to detect and interpret changes in the marine environment. Time-series datasets are a powerful tool that can increase our understanding of changes in marine biodiversity (Fig. 32.2). Most marine ecological datasets, however, are coastal and short in length, and not adequate to detect the influence of long-term changes, such as climate change and ocean acidification, on marine biodiversity. Where long time-series biodiversity datasets do exist, particularly when they cover a large spatial region, they can be used to explore a wide range of complex issues, such as marine biodiversity change in warming oceans, the impacts of fishing on marine ecosystems, and links between marine biodiversity and climate oscillations. Understanding such changes in marine biodiversity is necessary to ensure that conservation decisions, such as where to place an MPA or how to manage sensitive species, are based on good science.

In addition to biodiversity data, social data are important for effective marine conservation. Social data can reveal information about the impacts of biodiversity change or conservation measures on local communities, employment, or human welfare. This information is critical for understanding how conservation issues affect people and their livelihoods. People who have an interest in a specific marine conservation issue are called “stakeholders.” Depending on the issue in question, stakeholders may include, for example, fishermen, the general public, policymakers, or beach goers. To minimize negative impacts and ensure support for conservation measures, it is good practice to include stakeholders in the development and implementation of conservation measures.



**Fig. 32.2** A SCUBA diver collects biodiversity data at Shikine-jima, Japan

---

### 32.5 *Satoumi*: Traditional Application of the Ecosystem Approach in Japan

Japan has a history of applying an ecosystem approach to biodiversity management through *satoumi*. *Satoumi* is defined as “coastal sea areas where human influence has increased the productivity and biodiversity of the ecosystems” (Yanagi 2007). In *satoumi* areas, human interactions with marine systems, such as fishing, resource management, and even MPA creation, are based on environmental considerations and sustainable use. The *satoumi* system uses local scientific and community knowledge to make decisions about marine management, based on a philosophy of community responsibility. Stakeholders are an important component of *satoumi*, as local people are the key instigators of ecosystem enhancement, demonstrating their investment in their coastal environment (Hill et al. 2016). Japanese policymakers support this approach because it integrates conservation and sustainability to manage the coastal environment (Ota et al. 2011). The sustainability focus of *satoumi* means that it can also help to fulfill Japan’s Aichi target commitments (Berque and Matsuda 2013).

---

### References

- Berque, J., & Matsuda, O. (2013). Coastal biodiversity management in Japanese *satoumi*. *Marine Policy*, 39, 191–200.
- Halpern, B. S., Lester, S. E., & Kellner, J. B. (2010). Spillover from marine reserves and the replenishment of fished stocks. *Environmental Conservation*, 36, 268–276.
- Hill, L. S., Johnson, J. A., & Adamowski, J. (2016). Meeting Aichi target 11: Equity considerations in marine protected areas design. *Ocean & Coastal Management*, 134, 112–119.



- Mora, C., & Sale, P. F. (2011). Ongoing global biodiversity loss and the need to move beyond protected areas: A review of the technical and practical shortcomings of protected areas on land and sea. *Marine Ecology Progress Series*, 434, 251–266.
- Mora, C., Tittensor, D. P., Adl, S., Simpson, A. G. B., & Worm, B. (2011). How many species are there on earth and in the ocean? *PLoS Biology*, 9, e1001127.
- Ota, Y., Chiba, Y., & Dolan, J. (2011). *Mainstreaming Satoumi in Japanese national policy: Introduction to the case studies*, United Nations University Institute of Advanced Studies Operating Unit Ishikawa/Kanazawa, *Biological and Cultural Diversity in Coastal Communities* (Technical Series No. 61). Montreal, QC: Secretariat of the Convention on Biological Diversity.
- Sala, E., & Giakoumi, S. (2017). No-take marine reserves are the most effective protected areas in the ocean. *ICES Journal of Marine Science*, 75, 1166–1168.
- United Nations. (1992). *Convention on biological diversity of 5 June 1992*. <https://www.cbd.int/doc/legal/cbd-en.pdf>
- United Nations. (2000). *Decisions adopted by the conference of the parties to the Convention on Biological Diversity at its fifth meeting*, Nairobi, 15–26 May 2000. New York: United Nations.
- United Nations General Assembly. (2015). *Transforming our world: The 2030 agenda for sustainable development*, A/RES/70/1, p. 35.
- Yanagi, T. (2007). *Sato-umi, a new concept for coastal sea management* (p. 94). Tokyo: Terrapub.

### ***Further Reading***

- Roberts, C. (2007). *The unnatural history of the sea* (p. 435). Washington, DC: Island Press.

---

## Index of Taxa

### A

*Abylopsis*, 40–41  
*Acanthaster planci*, 207  
*Acanthometra*, 40–41  
*Acanthometron elasticum*, 26  
*Acanthopagrus schlegelii*, 94  
*Acanthopleura japonica*, 28  
*Acartia*, 40  
*Acetabularia* spp., 24  
*Acrocirrus validus*, 73  
*Acropora digitifera*, 332  
*Actinocyclus*, 40–41  
*Actinoptycus*, 40–41  
*Aequora victoria*, 8  
*Aequorea*, 40–41  
*Aglaophenia whiteleggei*, 66, 232  
*Ahnfeltiopsis concinna*, 57  
*Amathia imbricata*, 31  
*Ammothea hilgendorfi*, 31  
*Amphimedon queenslandica*, 332  
*Amphiprion perideraion*, 207  
*Amphiroa beauvoisii*, 26  
*Anthopleura asiatica*, 71  
*Anthopleura uchidai*, 28  
*Aplacophora*, 8  
*Aplysia californica*, 8, 177  
*Aplysia kurodai*, 72  
*Apostichopus japonicus*, 33  
*Aptenodytes patagonicus* (king penguin), 338  
*Arenicola marina*, 247  
*Ascipenser baerii*, 97  
*Asparagopsis taxiformis*, 53  
*Asterionellopsis*, 40–41  
*Astropecten kagoshimensis*, 33  
*Astropecten scoparius*, 73  
*Aurelia coerulea*, 28  
*Austruca lactea*, 207, 211–216  
*Avicennia* spp., 252

### B

*Bacteriastrum*, 40–41  
*Balanoglossus misakiensis*, 33  
*Bathygobius cocosensis*, 217  
*Bathygobius fuscus*, 33, 207, 217  
*Batillaria atramentaria*, 207–209, 211  
*Batillaria multiformis*, 211  
*Beroe*, 40–41  
*Boleophthalmus pectinirostris*, 207  
*Bolinopsis*, 40–41  
*Bolinopsis Mikado*, 97  
*Boltenia villosa*, 117  
*Botryllus scalaris*, 74  
*Brachionus*, 40–41  
*Branchiostoma floridae*, 332  
*Branchiostoma japonicum*, 33  
*Bruguiera* spp., 252  
*Bryopsis* spp., 25  
*Byblis japonicus*, 73

### C

*Calanus*, 40  
*Callophyllis adnata*, 57  
*Calocalanus pavo*, 40  
*Calothrix* sp., 26  
*Calotomus japonicus*, 232  
*Calonectris leucomelas* (streaked shearwater), 338  
*Capitulum mitella*, 73  
*Caprellidae*, 235  
*Caretta caretta* (loggerhead turtle), 338  
*Carassius auratus*, 144  
*Caulerpa okamurae*, 26  
*Cellana toreuma*, 72  
*Ceratium*, 40–41  
*Ceriops* spp., 252  
*Chaenogobius annularis*, 217

*Chaenogobius gulosus*, 217, 218  
*Chaetoceros*, 36, 40–41  
*Chaetodontidae*, 237  
*Chaetosoma* sp., 31  
*Chirromantes haematocheir*, 73  
*Chlorostoma*, 209, 211  
*Chondracanthus intermedius*, 56  
*Chondrus*, 60, 151  
*Chondrus verrucosus*, 60  
*Chrysaora*, 40–41  
*Chrysochromulina*, 40–41  
*Chthamalus challengeri*, 76  
*Ciona intestinalis*, 94–97, 99, 101–104,  
 115–118, 194, 332  
*Ciona robusta*, 94, 96  
*Ciona savignyi*, 99  
*Cladophora* spp., 25  
*Cladophora wrightiana*, 60  
*Clupea pallasii*, 138  
*Clypeaster japonicus*, 110, 113  
*Clytia hemisphaerica*, 332  
*Codium cylindricum*, 60  
*Codium lucasii*, 71  
*Coeloplana willeyi*, 71  
*Colpomenia sinuosa*, 56  
*Copilia*, 40  
*Corethron*, 40–41  
*Coscinodiscus*, 36, 40–41  
*Creseis*, 40

**D**

*Dactyliosolen*, 40–41  
*Danio rerio*, 126  
*Dasyatis akajei*, 207  
*Delisea japonica*, 60  
*Dermonema pulvinatum*, 57  
*Desmarestia tabacoides*, 60  
*Detonula*, 40–41  
*Diadema setosum*, 66, 99  
*Diadema* spp., 237  
*Dictyocha*, 40–41  
*Dictyota*, 150  
*Dictyota dichotoma*, 60  
*Diliolum*, 40–41  
*Dinophysis*, 40–41  
*Discina*, 40–41  
*Ditylum*, 40–41  
*Dofleinia armata*, 71  
*Dolabella auricularia*, 72  
*Donax* spp., 245  
*Dudresnaya japonica*, 58

**E**

*Ebria*, 40–41  
*Echiniscoides sigismundi*, 31  
*Ecklonia cava*, 232–234  
*Ectocarpus siliculosus*, 332  
*Elaphe climacophora*, 251  
*Engraulis japonicus*, 135, 138  
*Enteromorpha*, 150, 155  
*Eubalaena glacialis*, 349  
*Eucampia*, 40–41  
*Euglenozoa*, 40–41  
*Eutintinnus lususundae*, 26

**F**

*Favella*, 40–41  
*Fistulobalanus albicostatus*, 31  
*Fucus*, 150–155  
*Fucus distichus*, 153, 154  
*Fugu rubripes*, 126  
*Fushitsunagia catenate*, 60

**G**

*Gelidium elegans*, 60  
*Gelidium yoshidae*, 58  
*Gephyrocapsa*, 40–41  
*Globigerina bulloides*, 26  
*Gloiopeltis complanata*, 58  
*Gloiopeltis furcate*, 58  
*Goniastrea*, 237  
*Gonionemus*, 40–41  
*Gonyaulax* sp., 26  
*Gracilaria gigas*, 60  
*Gracilaria textorii*, 60  
*Grateloupia asiatica*, 58  
*Guinardia*, 40–41  
*Gymnodinium* spp., 300

**H**

*Halichondria japonica*, 71  
*Halichondria okadai*, 71  
*Haliclona cinerea*, 28  
*Halophila*, 233  
*Halophila ovalis*, 26  
*Helicana tridens*, 207  
*Helice japonica*, 207  
*Heliocidaris crassispina*, 18, 33, 95, 99,  
 109–111, 113  
*Heliopora coerulea*, 301  
*Hemicentrotus pulcherrimus*, 94, 97, 99, 104,  
 106, 109–111, 332

*Hemifusus tuba*, 207  
*Hemigrapsus sanguineus*, 31  
*Hemigrapsus takanoi*, 22  
*Herdmania momus*, 33  
*Heritiera* spp., 252  
*Heterokontophyta*, 24, 232  
*Heterosigma*, 40–41  
*Hormiphora*, 40–41  
*Hormiphora palmata*, 28  
*Hydrocoyrne*, 40–41  
*Hypnea asiatica*, 60  
*Hypomesus nipponensis*, 140

**I**

*Ilyoplax pusilla*, 211–213  
*Ishige foliacea*, 55

**K**

*Karlodinium*, 40–41

**L**

*Laguncula pulchella*, 209  
*Laminariales*, 77, 90, 150, 232  
*Lateolabrax latus*, 207  
*Lauderia*, 40–41  
*Laurencia okamurae*, 58  
*Leathesia difformis*, 55  
*Leptocylindrus*, 40–41  
*Leptonychotes weddellii*, 336  
*Leucopsarion peterii*, 140  
*Ligia exotica*, 31  
*Lingula anatina*, 31  
*Liolophura japonica*, 72  
*Litopenaeus vannamei*, 332  
*Littorina brevicula*, 211  
*Loligo edulis*, 184  
*Loligo forbesi*, 176  
*Loligo peali*, 8  
*Lucifer*, 40  
*Lunella coreensis*, 211

**M**

*Macrocytis pyrifera*, 232  
*Macrophthalmus banzai*, 207  
*Macrophthalmus japonicus*, 207, 212, 213  
*Macrosetella*, 40  
*Magallana gigas*, 95  
*Martensia jejuensis*, 60  
*Mastocarpus yendoii*, 60

*Megaptera novaeangliae*, 348  
*Melibe viridis*, 72  
*Meretrix lusoria*, 28, 207  
*Meristotheca papulose*, 60  
*Merosirea*, 40–41  
*Mesodinium* spp., 23  
*Meuniera*, 40–41  
*Microdyctyon japonicum*, 54  
*Mictyris brevidactylus*, 207  
*Mirounga angustirostris*, 336  
*Mnemiopsis leidyi*, 332  
*Mola mola*, 337  
*Monodonta confuse*, 72  
*Monodonta labio*, 208, 211, 219–221  
*Monostorama nitidum*, 60  
*Montipora* spp., 301  
*Muggiaea*, 40–41  
*Mutimo cylindricus*, 58  
*Myelophycus simplex*, 60  
*Myrianida convoluta*, 31  
*Mytilus galloprovincialis*, 186, 187, 302

**N**

*Nassarius festivus*, 207, 211  
*Nematostella vectensis*, 332  
*Nemertopsis gracilis*, 28  
*Neobodo*, 40–41  
*Neodilsea yendoana*, 150  
*Neorhodella*, 40–41  
*Neptunea arthritica*, 28  
*Nerita albicilla*, 279  
*Nerita japonica*, 219–221  
*Nermatodermatids*, 167  
*Nerocila japonica*, 207  
*Nipponacmea fuscoviridis*, 121  
*Nipponocypris temminckii*, 100  
*Noctiluca*, 40–41  
*Nodilittorina*, 40  
*Nodilittorina radiata*, 76  
*Notoplana*, 40–41  
*Notoplana humilis*, 28

**O**

*Octopus vulgaris*, 28, 194  
*Ocyropsis*, 40–41  
*Odontella sinensis*, 26  
*Odonthalia corymbifera*, 150  
*Oikopleura gracilis*, 33  
*Oithona*, 40  
*Oithona nana*, 31  
*Ommastrephes bartrami*, 184

*Omphalius pfeifferi*, 97  
*Oncaea*, 40  
*Oncorhynchus keta*, 337  
*Oncorhynchus mykiss*, 126  
*Oryzias latipes*, 126, 204  
*Osedax*, 170  
*Osmerus mordax dentex*, 140

## P

*Padina arborescens*, 53, 60  
*Pagurus filholi*, 208, 210, 278  
*Pagurus lanuginosus*, 208, 210  
*Pagurus minutus*, 208–212  
*Pagurus nigrofascia*, 209  
*Palaemon paicificus*, 73  
*Palmaria palmata*, 152, 158–160  
*Paracentropogon rubripinnis*, 74  
*Paranthus sociatus*, 207  
*Parasesarma bidens*, 276, 277  
*Patelloida saccharina*, 72  
*Patiria pectinifera*, 73  
*Penilia*, 40  
*Peregrinamor oshimai*, 207  
*Peridium*, 40–41  
*Periophthalmus modestus*, 200  
*Perophora japonica*, 194  
*Petalonia binghamiae*, 60  
*Phallusia mammillata*, 99  
*Phallusia nigra*, 99  
*Phascolosoma scolops*, 31  
*Philyra pisum*, 207  
*Phragmites australis*, 79, 249  
*Physalia physalis*, 71  
*Pinctada imbricate*, 72  
*Plecoglossus altivelis*, 140  
*Pleurobrachia bachei*, 332  
*Pleuronectes yokohamae*, 97  
*Pleurosigma*, 40–41  
*Plocamium telfairiae*, 26, 60  
*Podocoryne*, 40–41  
*Polycitor proliferus*, 74  
*Polykrikos*, 40–41  
*Polypterus* spp., 126  
*Porites*, 237  
*Portiera japonica*, 60  
*Posidonia*, 233  
*Posidonia oceanica*, 234  
*Prorocentrum*, 40  
*Protocystis*, 40–41  
*Protoperidinium*, 40–41  
*Pseudobiceros gratus*, 71

*Pseudocentrotus depressus*, 99  
*Pseudo-nitzschia*, 40–41  
*Pseudostylochus obscurus*, 71  
*Pteraeolidia semperi*, 72  
*Pterois lunulate*, 74  
*Ptilophora subcostata*, 60  
*Pyramimonas*, 40–41  
*Pyropia dentata*, 60

## R

*Reishia clavigera*, 210, 211  
*Rhizophora* spp., 251  
*Rhizophora stylosa*, 276  
*Rhizosolenia*, 40–41  
*Rhodomonas*, 40–41  
*Riftia pachyptila*, 170  
*Roughskin dogfish*, 258  
*Ruditapes philippinarum*, 207

## S

*Sabellastarte* sp., 73  
*Saccharina japonica*, 150, 232  
*Saccostrea kegaki*, 72  
*Sagitta*, 40–41  
*Sapphirina auronitens*, 40  
*Sargassum*, 150  
*Sargassum fusiforme*, 26, 60  
*Sargassum horneri*, 54  
*Sargassum macrocarpum*, 56  
*Sargassum ringgoldianum*, 60  
*Sargassum thunbergii*, 55  
*Scaphechinus mirabilis*, 110  
*Scaridae*, 237  
*Scopimera globosa*, 211, 212, 215  
*Scripsiella*, 40–41  
*Scytosiphon lomentaria*, 60  
*Sebastiscus marmoratus*, 74  
*Sepioteuthis lessoniana*, 184  
*Sillago japonica*, 100  
*Skeletonema*, 40–41  
*Solenicola*, 40–41  
*Sonneratia* spp., 252  
*Spheniscus demersus*, 336  
*Spirinchus lanceolatus*, 140  
*Spirobranchus kraussii*, 73  
*Spisula solidissima*, 332  
*Stephanopsis*, 40–41  
*Sticholonche*, 40–41  
*Strongylocentrotus purpuratus*, 99, 332  
*Styela clava*, 117

*Styela plicata*, 115–117  
*Symbiodiniaceae*, 236  
*Synchaeta vorax*, 28

**T**

*Takifugu niphobles*, 97  
*Takifugu rubripes*, 332  
*Tegula pfeifferi*, 232, 234  
*Temnopleurus hardwickii*, 109  
*Temnopleurus reevesii*, 109–110  
*Terebralia palustris*, 80  
*Tetraclita japonica*, 76  
*Tetraodontidae balistidae*, 237  
*Thalassionema*, 40–41  
*Thalassiosira*, 40–41  
*Thalassiosira pseudonana*, 332  
*Thalassoma cupido*, 100  
*Thaliacea*, 40–41  
*Trachurus japonicus*, 95  
*Trichodesmium*, 40–41  
*Trichoplax* sp., 71  
*Tricleocarpa jejuensis*, 57  
*Trinorchestia trinitatis*, 31  
*Turbo sazae*, 66

**U**

*Ulva*, 150  
*Ulva australis*, 60, 150  
*Ulva linza*, 26  
*Ulva pertusa*, 53  
*Ulva* spp, 24, 156, 157, 300  
*Umbonium moniliferum* (-) *Ibokisago*,  
209, 211  
*Umbraulva japonica*, 54  
*Undaria pinnatifida*, 26, 60, 232  
*Upogebia major* (*Japanese mud shrimp*)  
*Anajyako*, 207

**V**

*Vargula*, 40  
*Vorticella*, 40–41

**Z**

*Zonosagitta bedoti*, 33  
*Zostera*, 233  
*Zostera marina*, 26, 234

---

# Subject Index

## A

Abalones, 27, 66, 232  
Abysal, 226, 227, 257, 347  
Acetylcholine, 94, 97, 106  
Acoels, 167  
Acorn worms, 32, 33  
Acroporids, 237  
Acrosome, 14, 94, 96, 98  
Actinopterygii, 32, 40–41  
Actinotrocha larvae, 165  
Aichi targets, 349, 351  
Algal blooms, 36, 300, 301  
Alveolata, 23, 36, 40–41  
Ambulacraria, 165, 166, 168, 170  
Amoebozoa, 19, 36, 37  
Amphipods, 30, 31, 80, 235, 244, 245, 249, 257, 258  
Anemonefish, 28, 207, 279  
Angiotensin II (Ang II), 199  
Anisogamy, 151, 152, 156  
Annelida, 22, 27, 170  
Antarctica, 256, 336  
Antarctic, 5  
Appendicularia, 40–41  
Apusomonads, 36  
Aquaculture, 89, 147, 177, 226, 228, 299, 302, 345  
Aquaria, 121, 218, 302  
Archaea, 18, 19, 22  
Archaeplastida, 19, 36, 40–41  
Archibald Vivian Hill, 177  
Arrow worms, 30, 33, 169  
Arthropoda, 22, 170  
Artificial fertilization, 89, 120, 128, 129, 137, 139, 140  
Ascidians, 40–41, 69, 89, 94–97, 99, 101–106, 115–120, 175, 192, 232, 234, 256–258  
Asteroids, 40–41, 168, 257, 258  
Atlantic, 4, 5, 234, 302, 303, 349

Atlantic Salmon, 302  
*Aurelia*, 28, 40–41  
Auricularia, 165, 168  
Autonomous Reef Monitoring Structures (ARMS), 330  
Autotrophy, 19, 257, 342  
Auxospore, 24

## B

Bacillariophyceae, 40–41  
Bacteria, 4, 17–19, 22, 23, 36, 40–41, 170, 228, 235, 299, 300, 302, 303, 310, 342, 345  
Bacteriovorus nanoflagellate, 342  
Baer, K. F., 87  
Ballast water, 261, 302  
Barfin flounder, 135  
Barnacles, 29, 31, 39, 69, 170, 242, 244, 264  
Bathyal, 226, 227, 259  
Bathypelagic zone, 226  
Behavioral tactics, 278  
Belt transects, 238, 265, 267  
Benthic, 6, 19, 24, 25, 29, 30, 32, 67, 79, 80, 163, 164, 226, 231, 233, 246, 247, 252, 257, 259, 261, 298, 325, 348, 349  
Benthos, 4, 6, 19, 231, 233, 299  
Bern, H.A., 177  
Bicosoecia, 40–41  
Bilateral symmetry, 24, 32  
Bilateria, 25, 27, 29, 32, 166, 168, 169  
Binomial nomenclature, 22  
Biodegradable waste, 299  
Biodiversity, 7, 226, 250, 256, 329, 330, 347–351  
Biodiversity loss, 304, 349  
Biogenic habitats, 256  
Biogeochemistry, 307  
Biologger, 178

- Biological Information System for Marine Life (BISMaL), 330, 331
- Bioluminescence, 256
- Bipinnaria, 40–41, 165, 168
- Bivalves, 8, 81–83, 95, 186, 245, 257, 332
- Blastoderm, 88, 89, 111, 113, 114, 116, 117, 120, 121, 123, 126–130, 136, 137, 142, 143, 145, 146, 163
- Bleaching, 228, 238, 279, 281
- Blood vessels, 194
- Bloodworms, 27
- Blue-green alga, 23, 26
- Blue-ring octopus, 238
- Body color, 177, 202, 204, 249
- Body segments, 30
- Bony fish, 32
- Brachiopods, 7, 29, 40–41, 169
- Brachyra, 40
- Bristle worms, 27, 31
- Brittle stars, 32, 165
- Broadcast spawning, 7
- Brown algae, 24, 26, 77, 150–155, 332
- Brown sole, 130
- Bryozoa, 29, 40–41, 69, 232, 236
- Buoyancy, 6, 33, 36, 261
- Byssus, 182, 186–190, 192
- C**
- Ca<sup>2+</sup> indicator, 104
- Ca<sup>2+</sup> waves, 103, 104, 106
- Calcitonin, 199, 201
- Calcium carbonate skeletons, 236
- Calcium ionophore, 100
- Calcium metabolism, 201
- Camille Sauvageau, 90
- Capelin, 140
- Carbon, 4, 90, 226, 231, 232, 286, 289, 290, 300, 303, 304, 322, 347, 348
- Carbon cycling, 4, 36, 286
- Carotenoids, 24
- Carposporophytes, 150, 158–160
- Catch contraction, 186, 188, 192
- Catch muscle, 177
- Cell cycle, 88, 103
- Census of Marine Life (CoML), 330
- Centrohelid, 40–41
- Cephalopods, 8, 27, 83, 176, 182, 192
- Cercozoa, 40
- Chabry, L., 89
- Chaetognatha, 30, 40–41
- Challenger Deep, 4
- Chemosynthesis, 226, 257
- Chemotaxis, 96, 151
- Chinese Mitten Crab, 302
- Chitons, 27, 28
- Chlorofluorocarbons (CFCs), 302, 304
- Chlorophyll, 24, 52, 294, 310
- Chlorophyta, 24, 40–41
- Chordata, 32, 40–41
- Chorion, 96, 116, 118, 119, 130, 142
- Chromatophores, 202, 203
- Chum salmon, 337
- Ciliates, 23, 40–41, 342
- Circulating system, 177
- Cirripedia, 29
- Cladocera, 40
- Clams, 27, 28, 89, 94, 186
- Clark-type electrodes, 322
- Climate change, 279, 299, 304, 319, 325, 330, 348, 350
- Cnidaria, 25, 36, 40–41, 83, 166, 168, 236, 257, 258, 279, 332
- CO<sub>2</sub> emissions, 228, 303
- CO<sub>2</sub> seeps, 304, 326
- Coastal vegetation, 305
- Coccolithophores, 4, 324
- Cockles, 27
- Colonial ascidians, 78, 175
- Columbus, C., 14
- Comb jelly, 28, 97
- Conduction velocity, 183, 185, 186
- Conductivity–temperature–depth (CTD), 37, 261, 286, 308, 309, 311
- Conklin, E., 89, 116
- Conservative wastes, 299, 301
- Consumption rates, 276, 277
- Continental shelf, 226
- Continuous plankton recorder (CPR), 37
- Convention on Biological Diversity (CBD), 349
- Cook, J., 14
- Copepods, 29, 31, 39, 40, 257, 286
- Copulation, 27, 212
- Coral reefs, 7, 82, 226, 233, 234, 236–238, 256, 279, 298–301, 303, 347
- Coriolis effect, 5
- Cortical granules, 96
- Cowries, 27
- Crabs, 22, 30, 31, 79, 206–208, 210–213, 215, 216, 235, 246, 252, 276–279
- Crinoids, 168, 257, 258
- Crustaceans, 29, 30, 78, 81–83, 170, 177, 206, 232, 235, 256, 257, 265
- Cryptista, 36, 40–41
- Cryptophyta, 40–41
- Ctenophores, 25, 36, 40–41, 89, 166, 332
- Culture-independent methodologies, 342, 345



- Cuttlefish, 27, 298  
 Cyanobacteria, 23, 36, 40–41  
 Cyclin, 8, 88, 89  
 Cyphonautes larva, 29  
 Cypris larva, 170  
 Cytochrome oxidase I (COI/COX1), 332
- D**
- Dan, J.C., 14, 87  
 Dan, K., 14  
 Darwin, C., 37  
 Davidson, E., 89  
 Decapod, 22, 30, 80, 94, 206, 257  
 Dechoriation, 105, 119, 129, 143  
 Decomposers, 19, 36  
 Deep-water canyons, 226  
 Demersal eggs, 128, 138–144  
 Deuterostomia, 32  
 Diatoms, 4, 6, 23, 24, 26, 36, 39–41, 78, 232, 256, 332  
 Dinoflagellates, 4, 7, 19, 23, 26, 40–41, 279, 300  
 Dinophyta, 23, 40–41  
 Dioecious organism, 25, 27–30, 32  
 Dipleurula, 164, 166  
 Dissipating wastes, 299, 300  
 Dissolved inorganic carbon (DIC), 286, 320, 322–324  
 Dissolved organic carbon (DOC), 289, 290, 342  
 Dissolved organic matter (DOM), 6, 36, 309, 310  
 Diving, 50, 70, 269, 336  
 DNA barcoding, 332  
 Döderlein, L.H.P., 14  
 Dohrn, A., 89  
 Domain, 17, 22  
 Downwelling ( $E_d$ ), 313, 314  
 Dredges, 67, 259–261, 269  
 Driesch, H., 89  
 Dynamite fishing, 227  
 Dynein, 93
- E**
- Earthworms, 27  
 East China Sea, 8  
 Ecdysozoa, 29–31, 166  
*Echinodermata*, 32, 40–41  
 Echinoderms, 7, 32, 164–166, 168, 170, 237  
 Echinoids, 40–41, 78, 168, 256  
 Echinopluteus, 40–41, 165, 168  
 Echinozoa, 18  
 Echiurans, 257, 258
- Ecosystem engineer, 252, 256  
 Ecosystem resilience, 299  
 Eeltail catfish, 66  
 Egg, 39, 88, 89, 96–98, 103–106, 110, 111, 113, 122, 126, 128, 130, 135–137, 139, 142, 143, 145, 146, 151, 152, 154, 158  
 Egg jelly, 96, 98  
 Elasmobranchs, 257  
 Electroporation, 118–120  
 Embryo, 40–41, 103, 114, 116, 127, 137, 139, 140, 142, 145, 146, 163  
 Embryonic development, 27, 30, 126–147  
 Embryonic induction, 126  
 Endocrine disruption, 178, 301  
 Endocrine glands, 177  
 Environmental DNA (eDNA), 228, 332  
 Epibenthic, 67, 75, 235, 241  
 Epifaunal, 235  
 Epifaunal benthos, 19, 80  
 Epipelagic zones, 226, 227  
 Epiphytes, 53, 79, 81, 235  
 Epiphytic flora and fauna, 232  
 Estuaries rocky reefs, 226, 234  
 Ethology, 175–178  
 Eukarya, 17–19  
 Eukaryotes, 8, 18, 19, 22, 23, 36, 37  
 European Molecular Biology Laboratory  
   European Bioinformatics Institute  
   (EMBL-EBI), 332, 333  
 Eutrophication, 36, 248, 300, 325  
*Evadne*, 40  
 Evolution, 8, 15, 19, 36, 89, 115, 163–170, 178, 192, 199  
 Excavata, 19, 36, 37, 40–41
- F**
- Family, 8, 22, 235, 236  
 Fauna, 7, 8, 14, 30, 70, 75, 78, 226, 232, 235, 237, 238, 249, 250, 256–259, 267, 302, 303, 321  
 Faviidae, 301  
 Feather stars, 32, 168  
 Fertilization, 7, 8, 27–30, 94, 96, 98, 101–104, 106, 110, 112, 113, 115, 117, 119, 122, 126, 129, 137–139, 142, 151–160  
 Fertilization membrane, 96  
 Fertilizers, 299, 300  
 Filtration, 27, 251, 289, 294, 309, 310, 342  
 Fish, 7, 32, 33, 36, 40–41, 70, 78, 81–83, 88, 89, 94, 96, 98, 126–147, 177, 178, 198–203, 216, 218, 219, 226–228, 235, 237, 238, 249, 259, 273–276, 287, 298–300, 302, 337, 342, 345, 349

- Fish farms, 287, 299  
 Fishing, 70, 110, 206, 226, 228, 238, 274, 298,  
 300, 301, 304, 349, 350  
 Flagella, 23, 24, 94, 151, 156  
 Flatworms, 26, 28, 69  
 Floating pelagic eggs, 135–138  
 Flora, 4, 8, 14, 226, 232, 235, 237, 249,  
 302, 321  
 Flow cytometry, 342  
 Fol, H., 87  
 Follicle cells, 104, 118, 121  
 Food webs, 4, 14, 15, 19, 36, 226, 227, 235,  
 236, 252, 301–302, 348  
 Foraminifera, 23, 24, 40–41  
 Foundation species, 244, 256  
 Fucoxanthin, 24, 52  
 Fukushima, 302  
 Fungi, 18, 19, 23, 36
- G**
- Gametes, 8, 23–25, 89, 94–106, 151, 152,  
 156, 157  
 Gametophytes, 24, 25, 90, 150–152, 156–160  
 Ganglia, 177  
 Ganglion, 30, 116, 120, 182–184, 186,  
 189, 190  
 Garbage patches, 301  
 Gas exchange, 301, 322  
 Gastropods, 8, 27, 69, 78, 81–83, 96, 121, 208,  
 210, 219, 221, 232, 242, 256, 278, 279,  
 285, 301  
 Gastrulation, 113, 118  
 GenBank, 332  
 Genomic information, 20, 332  
 Genus, 22, 101, 170, 208, 251, 252  
 Germinal vesicle breakdown (GVBD), 122  
 Ghost fishing, 298, 301  
 Giant amphipod, 258  
 Giant axon, 8, 176, 177, 182–186  
 Global Ocean Sampling (GOS), 332, 344  
 Goldfish, 128, 135, 142–145  
 Gonadotropin-releasing hormone (GnRH), 177  
 Gonads, 94–96, 98, 102, 117, 122, 126, 128,  
 140, 141, 194  
 Gonad–somatic index (GSI), 94  
 Gonad stimulating substance (GSS), 177  
 Gonopores, 94, 112  
 Gorbman, A., 177  
 GPS, 178, 336, 337  
 Grabs, 269  
 Grand Banks of Newfoundland, 298  
 Gray, J., 177  
 Grazing food chain, 342  
 Great Barrier Reef, 236  
 Great East Japan Earthquake, 302  
 Green algae, 24, 26, 150–152, 155–158  
 Greenling, 130  
 Gyres, 5, 301, 303
- H**
- Habitat simplification, 304  
 Hadal, 226  
 Hadal trench, 259  
 Haeckel, E., 89  
 Halogenated hydrocarbons, 301  
 Haptophyta, 36, 40–41  
 Harmful algal blooms, 36, 228, 300  
 Harpacticoids, 247, 257  
 Hatai, S., 177  
 Heart, 116, 118, 191–195  
 Heliozoa, 40–41  
*Hemichordata*, 32, 40–41  
 Herbivorous fish, 232  
 Hermaphroditic organism, 25, 29, 30, 32, 102,  
 103, 117  
 Hermaphroditism, 25, 29, 30, 32, 102,  
 103, 117  
 Hermatypic corals, 82, 236, 320–325  
 Hertwig, O., 87  
 Heterocysts, 23  
 Heterokont, 24, 151, 232  
 Heterotroph, 19, 23, 342, 345  
 Heterotrophic, 292, 342, 345  
 High biodiversity, 256  
 High primary production, 83, 235, 256  
 Hilgendorf, F. M., 14  
 Hiramoto, Y., 14, 88  
 Histocompatibility, 175  
 HMS Beagle, 14  
 HMS Challenger, 14  
 Hodgkin, A., 8, 176  
 Holdfasts, 50, 232, 234  
 Holoplankton, 35  
 Holothurians, 168, 232, 257, 258  
 Hormones, 94, 177, 199, 201–203  
 Horstadius, S., 89  
 Hugo Grotius, 297  
 Humans, 15, 32, 142, 177, 227, 261, 279, 286,  
 294, 298–305, 336, 345, 348–351  
 Humpback whale, 348  
 Hunt, R.T., 8  
 Huxley, A., 8, 176  
 Hydrocarbon seeps, 257  
 Hydrodynamic effect, 7  
 Hydroids, 6, 25  
 Hydrostatic pressure, 191, 192, 194, 195, 256

Hydrothermal vents, 170, 226, 256, 257,  
261, 299  
5-hydroxytryptamine (5-HT, serotonin), 187  
Hydrozoans, 69, 78, 232, 256  
Hypoxic layer, 303

**I**

Ice goby, 128, 140–143  
Immune system, 175  
Imposex, 301  
Indian Ocean, 4, 5  
Industrial Revolution, 303  
Infaunal, 78, 80, 235, 241  
Infaunal benthos, 19  
Inoue, S., 88  
Inseminations, 8, 89, 94, 98, 103, 118, 119,  
129, 142, 159  
Internal transcribed spacer (ITS), 332  
International Census of Marine Microbes, 344  
The International Whaling Commission  
(IWC), 348  
Intertidal, 22, 27, 30, 77, 79, 80, 110, 206,  
208, 211, 216, 219, 221, 226, 263, 264,  
267, 302  
Intertidal zones, 121, 155, 219, 226, 241–253,  
256, 325  
Invagination, 127, 128  
Invasive species, 228, 302  
Ion channels, 8, 176  
Ishigaki Island, 81, 301  
Isogamy, 90, 151, 152  
Isokont, 151  
Isopods, 30, 31, 235, 244, 257  
Isoyake, 232  
Izu-Ogasawara trench, 14

**J**

Jackass penguins, 336  
Japanese anchovy, 135–138  
Japanese Association for Marine Biology  
(JAMBIO), 330  
Japanese oysters, 302  
Japanese rice fish, 126  
Japan Sea, 8  
Japan trench, 14, 226  
Jawless fishes, 32  
Jellyfishes, 6, 8, 25, 28, 35, 36, 88, 94, 177, 279

**K**

Kaempfer, E, 14  
Kamata, T., 177

Kanatani, H., 14, 89, 177  
Kanda, T., 90  
Kandel, E., 8, 177  
Karyogamy, 160  
Kelp forests, 77, 78, 226, 231, 232, 234, 256,  
301, 303, 347  
Kinesin, 177  
Kingdom, 22, 192  
King penguin, 338  
Kinoshita, H., 177  
Komai, T., 89  
Kuroshio, 14, 226

**L**

Lamp shells, 29, 31  
Lancelets, 32, 33, 332  
Larva, 27, 40–41, 89, 111, 115, 118,  
163–166, 168  
Larvaceans, 32, 33, 36  
Larvae, 29  
Larval stages, 27, 30, 32, 90, 123, 163,  
164, 166  
Leeches, 27  
Lillie, F., 87  
Limpets, 27, 121, 123, 170, 219  
Line-intercept, 238, 265, 267, 268  
Lionfish, 302  
Lobe-finned fishes, 32  
Lobsters, 30, 36, 66  
Loeb, J., 87  
Loggerhead turtle, 338  
Lorenz, K.Z., 178  
Loss of biodiversity, 304  
Low temperature, 256  
Lugworms, 27, 247, 248

**M**

Macroalgae, 24–26, 50, 51, 77, 150–160, 232,  
235–237, 242, 265  
Macroalgal dominance, 304  
Macrofauna, 75, 232, 246, 247, 257  
Mangrove forests, 80, 81, 250–252, 277  
Mangroves, 19, 69, 80, 226, 250–252,  
305, 348  
Manipulative, 316–317  
MarBEF, 332  
Marianas trench, 4  
Marine animals, 6, 7, 19, 65–74, 89, 94–96,  
106, 175–178, 202, 302, 336, 337, 345  
Marine Biological Laboratory (MBL), 31, 89  
Marine conservation, 347–351  
Marine Genomics Europe (MGE), 332

- Marine heat waves, 228, 303  
 Marine mammals, 178, 337  
 Marine Metagenomics Portal (MMP), 332  
 Marine pollution, 299–302, 304  
 Marine Protected Areas (MPAs), 349  
 Marine snow, 14, 257  
 Marine stations, 14, 15, 67, 70, 89, 94, 109, 110, 126, 147, 178, 320  
 Maritime transport, 226, 299  
 Maturation-promoting factor (MPF), 89  
 Medaka, 89, 126, 139, 204  
 Meiobenthos, 236, 260  
 Meiofauna, 69, 247, 257, 259  
 Meiosis, 94, 104  
 Melanin-concentrating hormone, 202  
 Melanocyte-stimulating hormone, 202  
 Melatonin, 202  
 Mensurative, 316  
 Meroplankton, 35  
 Mesocosm, 325  
 Mesopelagic zone, 227  
 Mesozooplankton, 342  
 Metagenomics, 332, 344, 345  
 Metazoa, 164  
 Microalgae, 23, 79–82, 235, 236, 249, 252, 342  
 Microbes, 4, 342–345  
 Microbial loop, 19, 36, 342  
 Microbiomes, 332, 345  
 Microcosms, 316, 317, 319–325  
 Microinjection, 105, 118, 130–137, 139, 142  
 Micropyles, 96, 97, 136  
 Micro-surgery, 130  
 Microtubules, 14, 24  
 Misaki Marine Biological Station, 182  
 Mitosis, 8, 88, 97, 160  
 Mohri, H., 14  
 Mollusca, 7, 27, 121, 170  
 Monostromatic tubular thalli, 155, 156  
 Monroy, A., 89  
 Moray eels, 66, 238  
 Morgan, T.H., 89  
 Morphological and anatomical observation, 51  
 Morse, E.S., 14  
 Moss animals, 29, 31  
 Moy, G., 87  
 Mud flats, 78, 79, 246, 247  
 Multicellularity, 18  
 Muscle, 116–118, 120, 127, 170, 177, 182, 184, 186–190, 192, 199  
 Mussels, 27, 76, 77, 94, 177, 244, 302  
 Myoplasm, 116–117  
 Mysis larva, 165
- N**  
 Nankai trough, 14  
 Nanomonadea, 40–41  
 National Bureau of Standards (NBS), 323  
 National Institute of Standards and Technology (NIST), 323  
 Natural products, 176  
 Nauplius larvae, 30  
 Nautilus, 27  
 Necrophagous, 259  
 Nectochaete larvae, 40–41  
 Nematodes, 82, 169, 247, 257  
 Neon flying squid, 184  
 Nerve, 32, 120, 165, 170, 176, 177, 182–184, 186, 189, 190, 192  
 Neurons, 177  
 Neurotransmitters, 186, 189  
 Neurulation, 118  
 Next-generation sequencing, 344  
 Niskin bottles, 293, 307–309  
 Nitrogen, 23, 53  
 NORPAC, 37  
 North Atlantic right whale, 349  
 North Pacific Ocean, 8  
 Notochord, 32, 115, 116, 120, 127, 170  
 Nuclear power stations, 300  
 Nutrients, 4, 6, 14, 30, 36, 192, 226, 236, 248, 279, 290, 300, 303, 322, 324, 325, 342
- O**  
 Ocean acidification, 228, 238, 304, 319–325, 348, 350  
 Ocean Biogeographic Information System (OBIS), 330  
 Ocean sprawl, 299  
 Ocean sunfish, 337  
 Ochrophyta, 23, 24, 40–41  
 Octopuses, 27, 66, 182, 191, 192, 194, 195, 206, 238  
*Oikopleura*, 40–41  
 Oil spills, 299  
 Oka, H., 175  
 Onychophora, 7, 163  
 Oocytes, 14, 89, 97, 102, 121, 122, 177  
 Oogamy, 24, 90, 151, 152  
 Operational taxonomic units (OTUs), 343, 344  
 Ophiopluteus, 165, 168  
 Ophiopluteus larvae, 40–41  
 Ophiuroids, 168, 257, 258  
 Opisthokonta, 19, 36, 37, 40–41  
 Optodes, 322

- Order, 4, 17, 22, 25, 77, 89, 105, 126, 129, 139, 141, 146, 178, 186, 195, 221, 232, 236, 264, 266, 267, 269, 279, 286, 314, 316, 325
- Organic matter flux, 342
- Organotin compounds, 301
- Osmoregulation, 199
- Over fishing, 298
- Oviduct, 97, 99, 102, 103, 115, 117
- Oxygen, 4, 6, 14, 19, 23, 70, 90, 126, 136, 140, 235, 251, 256, 261, 286, 292, 300, 322, 323, 325, 347
- Oxygen minimum zone, 14
- Oyashio, 14
- Oysters, 27, 77, 244, 302
- Ozone hole, 302
- P**
- Pace-makers, 192, 193, 195
- Pacific grenadier, 258
- Pacific herring, 138–140
- Pacific Ocean, 4, 5, 138, 302
- PANGAEA, 333
- Parallax, 238
- Particulate organic carbon (POC), 289, 290
- Particulate organic matter (POM), 36, 294, 310
- Peanut worms, 29, 31
- Pelagic, 6, 25, 29, 36, 128, 135–138, 163–165
- Pelagospira larva, 40–41
- Penguins, 336, 337
- Percentage cover, 264–266
- Phoronida, 40–41
- Phosphorus, 290
- Photosynthesis, 19, 23, 24, 36, 227, 256, 286, 292, 304, 313, 314, 322–324, 345
- Photosynthesis, respiration, calcification, 321
- Photosynthetically active radiation (PAR), 313
- Phototaxis, 151, 156, 157
- pH-stat, 317
- Phycobilins, 24
- Phylum, 7, 17, 22, 23, 29, 30, 121, 164, 167, 168, 170, 232, 236, 279
- Phytoplankton, 4, 7, 36, 37, 227, 236, 289, 290, 292, 300, 309, 313, 342, 347
- Pigment composition, 23, 52
- Pigment granules, 202–204
- Placozoa, 166
- Plankton, 4, 6, 35–40, 228, 259, 319, 325, 348
- Plankton nets, 37–39, 164, 259, 261
- Platyhelminthes*, 26, 40–41, 165
- Pleocyemata, 22
- Pneumatocysts, 24
- Point intercept, 265
- Polar body, 121, 123
- Polarizing microscope, 88
- Policy, 304, 348
- Polychaetes, 27, 80, 82, 83, 245, 247, 249, 257, 258
- Polyplacophora, 8, 27
- Polyzoans, 78, 256
- Pond smelts, 140, 141
- Porifera, 25, 166
- Poritidae, 301
- Predation impact, 273
- Predator–prey relationships, 342, 348
- Predators, 36, 78, 80–82, 164, 178, 182, 192, 206, 213, 217, 225, 232, 236, 249, 252, 256, 257, 259, 261, 274, 276, 278, 336
- Primary consumers, 36, 80, 249
- Primordial germ cells (PGCs), 128, 130, 136, 137, 139, 140, 146
- Prokaryotes, 8, 17, 19, 22, 36, 257, 332
- Pronucleus, 98
- Prorocentrum*, 40–41
- Proteobacteria, 344
- Proteomics, 321
- Proteorhodopsin, 344, 345
- Protista, 18
- Protostomia, 25, 27, 29
- Pteropoda, 40
- Pufferfishes, 97, 126, 332
- Q**
- Quadrats, 215, 232, 234, 235, 238, 264–267, 270, 274, 275, 285
- R**
- Radially symmetry, 24
- Radioactivity, 301
- Radiolarians, 23, 24, 26, 40–41
- Radiozoa, 40–41
- Rag worms, 27
- Rainbow trout, 126
- Random sampling, 263, 264
- Ray-finned fishes, 32
- Recorders, 187, 336, 337
- Red algae, 24, 26, 52, 53, 150–152, 158, 242
- Reef check, 238
- Refuge, 77–80, 82, 232, 256
- Remotely operated vehicles (ROVs), 260, 261, 270
- Replicates, 266, 269, 316, 317, 326

- Reproduction, 15, 23–25, 29, 90, 96, 150–152,  
 158, 164, 177, 178, 213, 217, 304  
 Restoration of mangroves, 305  
 Reynolds number, 7  
 Rhizaria, 36  
 Rhizoid, 152–155  
 Rhizomes, 25, 234, 235, 248  
*Rhodophyta*, 24, 40–41  
 Ribbon worms, 27, 28  
 RINKAI, 330  
 Rocky shores, 37, 65–67, 69, 75–83, 121, 208,  
 241–243, 246, 278  
 Rotifers, 25, 28, 169  
 Roughskin dogfish, 258  
 Roundworms, 30, 31  
 Ryukyu trench, 14
- S**
- Salinity, 6, 7, 14, 178, 198, 225, 226, 236,  
 249–251, 256, 286, 310, 311, 320, 322,  
 323, 325, 345  
 Salps, 32  
 Salt marsh, 79, 248–250  
 Sand dollars, 88, 165  
 Sandy beaches, 69, 78, 79, 244–246, 336  
 Sanriku, 14, 337  
 Satoh, N., 89  
*Satoumi*, 351  
 Scallop dredging, 227–228, 298  
 Scaphopoda, 8  
 Schmidt, W.J., 88  
 Sea anemones, 25, 28, 207, 279  
 Seabed regeneration zones, 304  
 Seabirds, 228, 299, 336, 338, 348  
 Sea cucumbers, 32, 33, 165, 177  
 Seagrass beds, 81, 82, 226, 234, 301  
 Seagrasses, 19, 24–26, 50, 81, 82, 233, 235,  
 274, 305  
 Seagrass meadows, 81, 233, 235, 237,  
 256, 348  
 Sea lilies, 168  
 Sea mouse, 27  
 Sea of Okhotsk, 8  
 Sea slugs, 8, 27, 177  
 Sea spiders, 29, 31  
 Sea squirts, 32, 33, 177  
 Sea stars, 164, 165  
 Sea urchins, 8, 18, 32, 33, 66, 78, 87–89,  
 94–99, 103, 104, 106, 109–114, 142, 165,  
 177, 235, 332  
 Seals, 336  
 Seawater sampling, 307–310  
 Seaweed farming, 305
- Sediment shores, 78  
 Sessile, 19, 27, 29, 75, 76, 78, 170, 242, 253,  
 256, 267, 330  
 Sessile animals, 67, 69  
 Seto Inland Sea, 300  
 Sharks, 70, 227, 228, 237, 257, 259, 337  
 Shell-choice experiment, 278–279  
 Shimoda Marine Research Center, 70  
 Shimomura, O., 8, 175  
 Shinya-Scope, 88  
 Shrimp farms, 305  
 Silicate, 286, 290, 292  
 Sipuncula, 27, 29, 40–41  
 Snailfish, 258, 259  
 Snails, 27, 28, 96, 97, 208, 220, 221  
 Soya current, 14  
 Spawning, 7, 14, 94, 101, 128, 136, 137, 140,  
 207, 235, 300  
 Spawning seasons, 96, 128, 140  
 Species, 6, 17, 22, 40, 50, 66, 77, 88, 94, 109,  
 126, 150, 163, 186, 198, 226, 231, 241,  
 256, 264, 298, 319, 329, 336, 343, 347  
 Species-specific recognition, 96  
 Sperm, 7, 94, 110, 129, 151, 298  
 Spermatia, 158–160  
 Sperm dimorphism, 96  
 Sperm duct, 94, 97–100, 102, 103  
 Sperm motility, 96, 98–101  
 Spiral cleavage, 120  
 Spiralia, 25, 27, 29, 120, 166  
 Sporophytes, 24, 25, 90, 150, 151, 156, 158, 159  
 Squids, 6, 8, 27, 176, 182–186, 192  
 Snails, 97  
 Stable isotopic ratios, 235  
 Stakeholders, 350, 351  
 Stalked ascidian, 258  
 Stanniocalcin, 199, 201  
 Starfishes, 32, 33, 89, 94, 177, 279  
 Stazione Zoologica Napoli (SZN), 89  
 Stonefishes, 238  
 Stramenopiles, 36, 40–41  
 Stramenopiles+Alveolata+Rhizaria (SAR),  
 19, 36, 37  
 Stratified random sampling, 263  
 Streaked shearwater, 338  
 Sturgeon, 97, 126  
 Sugashima Marine Biological Laboratory, 88  
 Supergroups, 19, 36, 37  
 Swimming, 7, 25, 29, 36, 70, 99, 113, 122,  
 123, 135, 156, 163, 164, 166, 168, 178,  
 202, 305, 336  
 Swordtip squid, 184  
 Symbiotic, 23, 170, 228, 273, 279  
 Systematic sampling, 267

**T**

Tadpole larva, 32, 40–41  
Tail bud, 116, 118, 146  
Tanaids, 257  
Tara Expedition, 333  
Taxonomy, 7, 18, 22–33  
Tectonic subduction, 226  
Teleosts, 94–96, 126, 128, 146, 147, 198, 199  
Temperature, 14, 39, 50, 111, 113, 122, 126, 128, 135, 136, 139, 140, 142, 143, 154, 178, 185, 186, 192–195, 225, 226, 232, 236, 238, 252, 256, 281, 286, 290, 292, 300, 303, 310–312, 317, 319, 320, 322, 323, 336, 337, 348  
Tethering experiment, 274, 276  
Tetraspores, 151, 158–160  
Thermocline, 6, 14  
Thick-branched pocilloporids, 237  
Thompson, J.V., 37  
Time-series, 350  
Tinbergen, N., 178  
Tornarias, 32, 165, 168  
Total alkalinity (TA), 320, 323, 324  
Transcriptomics, 321  
Transects, 238, 265, 267, 268, 270  
Transparency, 112, 118, 128, 286, 312  
Trawls, 67, 228, 259, 260, 269  
Tributyl Tin (TBT), 301  
Trichogyne, 151, 158, 160  
Trochophore, 27, 28, 121, 164–166, 170  
Tsugaru current, 14  
Tsukamoto, K., 14  
Tsushima current, 14  
Tunicates, 115, 170, 182, 192–195  
Turbellarians, 27  
Turtles, 83, 235, 301, 336, 337  
Type I error, 316  
Type II error, 316

**U**

Unicellular organisms, 19, 23, 24, 26, 37  
Upwelling ( $E_u$ ), 5, 226, 313

**V**

Vacquier, V., 87  
Van Wilson, H., 175  
Vascular systems, 32, 128, 192  
Veliger larva, 27, 121  
Velvet worms, 7, 163

Vertebrates, 32, 89, 115, 170, 177, 182, 192, 199, 201, 228  
Victor Hensen, 35  
Viridiplantae, 37  
Viruses, 19, 35, 36, 228, 302, 342, 347  
Viscosity, 6, 7  
Visual census surveys, 267, 270  
Vitelline membrane, 96, 98  
Voltage clamp, 176  
von Frisch, K., 178  
von Siebold, P.F.B., 14

**W**

Wada, E., 14  
Watanabe, H., 175  
Warming gasses, 303  
Waspfish, 66  
Water bears, 30, 31  
Water temperature, 152, 164, 255, 256, 279, 285, 310, 337  
Weddell seals, 336, 338  
Whelks, 27  
Whittaker, R., 18  
Wilson, E.B., 89  
Winkler method, 292, 322  
WP-2, 37

**X**

Xenacoelomorpha, 167  
Xenoturbellids, 167

**Y**

Yamamoto, T., 89  
Yatsu, N., 89  
Yolk cell, 127, 145, 146  
Yolk syncytial layer (YSL), 126, 127, 138, 143–146  
Young, J.Z., 176

**Z**

Zebrafish, 89, 126, 128, 139, 140, 142–146  
Zoea larva, 40, 165  
Zonation, 76, 77, 227, 237, 242–244, 249, 256  
Zooplankton, 29, 36, 37, 40, 228, 259, 302, 309, 342  
Zooxanthellae, 23, 236, 238, 279–281  
Zooxanthellae density, 279–281